

PD8-765 Explosion-Proof Process & Temperature Meter

Instruction Manual



ProtEx™
MAX



CapTouch™

- CSA, ATEX and IECEx Certified Explosion-Proof Meter
- 4-20 mA, ± 10 V, TC & RTD Field Selectable Inputs
- Full 4-Digit Display, 1.20" (30.5 mm)
- CapTouch Through-Glass Button Programming
- Display Mountable at 0°, 90°, 180°, & 270°
- Isolated 24 VDC @ 200 mA Transmitter Power Supply Option (AC powered meters only)
- 2 Relays + Isolated 4-20 mA Output Option
- Free PC-Based MeterView Programming & Monitoring Software
- Sunlight Readable Display
- Operating Temperature Range: -55 to 65°C (-67 to 149°F)
- CSA Certified as Explosion-Proof / Dust-Ignition-Proof / Flame-Proof
- ATEX and IECEx Certified as Dust-Ignition-Proof / Flame-Proof
- Input Power Options: 85-265 VAC / 90-265 VDC or 12-36 VDC / 12-24 VAC
- Duplex Pump Controller with Alternation Capability
- External Contacts for Remote Button Operation
- On-Board RS-485 Serial Communications
- Modbus® RTU Communication Protocol Standard
- Copy Meter Settings to Other PD8-765 Meters
- Password Protection
- Max/Min Display
- High & Low Alarms with Multiple Reset Actions
- Flanges for Wall or Pipe Mounting
- Explosion-Proof Aluminum or Stainless Steel NEMA 4X / IP68 Enclosures
- Four 3/4" NPT Threaded Conduit Openings
- Stainless Steel Pipe Mounting Kit
- Stainless Steel Tag Available
- 3-Year Warranty

PRECISION DIGITAL CORPORATION

233 South Street • Hopkinton MA 01748 USA
Tel (800) 343-1001 • (508) 655-7300
www.predig.com



The Complete **ProtEXTM** Series MAX



PD8-154
**4-Point Alarm
Annunciator**



PD8-6100
Strain Gauge Meter



PD8-158
**8-Point Alarm
Annunciator**



PD8-6200
**Analog Input
Flow Rate/Totalizer**



PD8-765
**Process &
Temperature Meter**



PD8-6210
**Analog Input Batch
Controller**



PD8-6000
Process Meter



PD8-6262
**Analog Dual-Input
Flow Rate/Totalizer**



PD8-6001
**Feet & Inches
Level Meter**



PD8-6300
**Pulse Input
Flow Rate/Totalizer**



PD8-6060
**Dual-Input
Process Meter**



PD8-6310
**Pulse Input
Batch Controller**



PD8-6080
**Modbus[®] Scanner
with Dual Analog Input**



PD8-6363
**Pulse Dual-Input
Flow Rate/Totalizer**



PD8-6081
**Feet & Inches
Modbus[®] Scanner**



PD8-7000
Temperature Meter

Go to PREDIG.COM for details on the entire ProtEX-MAX Series Meters

Disclaimer

The information contained in this document is subject to change without notice. Precision Digital makes no representations or warranties with respect to the contents hereof and specifically disclaims any implied warranties of merchantability or fitness for a particular purpose. See Warranty Information and Terms & Conditions on www.predig.com for complete details.

CAUTION

- Read complete instructions prior to installation and operation of the meter.

WARNINGS

- Risk of electric shock or personal injury.
- This product is not recommended for life support applications or applications where malfunctioning could result in personal injury or property loss. Anyone using this product for such applications does so at his/her own risk. Precision Digital Corporation shall not be held liable for damages resulting from such improper use.
- Failure to follow installation guidelines could result in death or serious injury. Make sure only qualified personnel perform the installation.
- Never remove the meter cover in explosive environments when the circuit is live.
- Cover must be fully engaged to meet explosion-proof/dust-ignition-proof/flame-proof requirements.

WARNING
Cancer and Reproductive Harm - www.P65Warnings.ca.gov

Limited Warranty

Precision Digital Corporation warrants this product against defects in material or workmanship for the specified period under "Specifications" from the date of shipment from the factory. Precision Digital's liability under this limited warranty shall not exceed the purchase value, repair, or replacement of the defective unit. See Warranty Information and Terms & Conditions on www.predig.com for complete details.

Registered Trademarks

All trademarks mentioned in this document are the property of their respective owners.

© 2023 Precision Digital Corporation.
All rights reserved.



FREE MeterView Programming Software



Note: PD8-765 meter is not powered from USB connection and requires external power to be programmed.

The PD8-765 is easily setup and programmed without removing the cover by using the four through-glass CapTouch buttons or by removing the cover and using the front panel push buttons. The meter can also be programmed using a PC and Precision Digital's free MeterView software or "cloned" with the Copy function. Programming the PD8-765 with MeterView software requires removing the front cover and connecting to the electronics module to the PC via the PDA8006 Trident USB serial adapter.

MeterView programming software is intuitive, and most customers can get their meter programmed as they like without even looking in the manual.

Watch MeterView Software Video at
<http://www.predig.com/meterview>

In addition to programming, the software, with the use of additional devices, may be used for:

- Monitoring
- Datalogging using your PC
- Generating and saving programming files for later use

Once your meter is programmed the way you want it, you can wire it up for your application per the instructions in this manual and install it. If you find that you need to make adjustments to the programming after the meter is installed, you can use the programming buttons and the instructions in this manual to do so.

WARNING

- When using the USB connection, the meter should only be connected to a computer when both devices are in a non-hazardous area.

Table of Contents

Introduction.....	7
Ordering Information.....	7
Helpful Videos.....	8
Key Features.....	9
Useful Tools.....	15
Specifications.....	16
General.....	16
Process Inputs.....	17
Temperature Inputs.....	17
Relays Option.....	18
External Button Contacts.....	18
Isolated 4-20 mA Transmitter Output Option.....	18
RS-485 Serial Communications.....	18
Modbus RTU Serial Communications.....	18
Enclosure.....	19
General Compliance Information.....	19
Electromagnetic Compatibility.....	19
Product Ratings and Approvals.....	19
EU Declaration of Conformity.....	21
Safety Information.....	21
Installation.....	21
Unpacking.....	21
Cover Jam Screw.....	21
Mounting.....	22
MeterView Software.....	24
Connections.....	30
Required & Factory Wired Connection.....	30
PD765 Trident Electronics Module Layout.....	31
Connector Labeling.....	31
Power Connections.....	32
Signal Connections.....	32
Relays and 24 V Output Connections.....	33
Switching Inductive Loads.....	33
RS-485 Connections.....	34
RS-485 Multi-Drop Connection.....	34
4-20 mA Output & Input Signal Connections.....	35
External Button Contacts.....	35
Setup and Programming.....	36
Overview.....	36
LED Status Indicators.....	36
Programming Buttons.....	37
CapTouch Buttons.....	37
Display Functions and Messages.....	38
Main Menu.....	39
Setting Numeric Values.....	39
Setting Up the Meter (SEtU).....	39
Setting the Input Signal (iNPT).....	39
Setting the Decimal Point (dCPt).....	40
Setting the Temperature Scale (F °C).....	40
Programming the Meter (PRoG).....	40
Scaling the Meter (ScRL).....	40
Calibrating the Meter (CR).....	41
Recalibrating Temperature Inputs (TR).....	41
Recalibrating Process Inputs (IPRL).....	41
Setting the Relay Operation (RELY).....	42
Acknowledging Relays.....	42
Relay and Alarm Operation.....	43
Scaling the 4-20 mA Analog Output (ROut).....	47
Program the Sensor Break Output Value (SEbr).....	47
Analog Output when Display is Out of Range.....	47

Setting Up the Password (P55)..... 48
 Locking the Meter 48
 Unlocking the Meter 48
Advanced Features Menu 48
 Advanced Features Menu & Display Messages 48
 Offset Adjustment (Adj) 49
 Noise Filter (FLt) 49
 Noise Filter Bypass (b5P5) 49
 Serial Communications (5ErL) 50
 Protocol Selection Menu (Pr0t) 50
 Select Menu (5ELt) 50
 Linear or Square Root Function (L inr or 5Rt) 50
 Low-Flow Cutoff (cutF) 50
 Display Intensity (inL) 51
 Meter Copy Function (L0P) 51
 Internal Calibration (iRL) 52
Meter Operation 53
Buttons Operation 53
Maximum/Minimum Readings 54
Remote Operation of Meter Buttons..... 54
Troubleshooting 55
Diagnostics Menu (d RL) 55
 Determining Software Version 55
Reset Meter to Factory Defaults 55
 Factory Defaults & User Settings 56
Troubleshooting Tips 57
Quick Interface Reference Guide 59

Table of Figures

Figure 1. Enclosure Dimensions – Front View.....	22
Figure 2. Enclosure Dimensions – Side Cross Section View	22
Figure 3: Integrated PD765 Trident Required Connections	30
Figure 4. PD765 Trident Electronics Module Layout	31
Figure 5. Connector Labeling for PD8-765-6X0-10	31
Figure 6. Connector Labeling for PD8-765-6X3-20	31
Figure 7. Connector Labeling for PD8-765-7X0-00	31
Figure 8. Connector Labeling for PD8-765-7X5-00	31
Figure 9. Power Connections	32
Figure 10. Transmitter Powered by Internal Supply	32
Figure 11. Transmitter Powered by External Supply or Self-Powered.....	32
Figure 12. Voltage Input Connections	32
Figure 13. Thermocouple Input Connections.....	32
Figure 14. Three-Wire RTD Input Connections	32
Figure 15. Two-Wire RTD Input Connections.....	33
Figure 16. Four-Wire RTD Input Connections	33
Figure 17. Relay & 24 V Output Connections.....	33
Figure 18. AC and DC Loads Protection.....	33
Figure 19. Low Voltage DC Loads Protection	33
Figure 20. RS-485 Connections	34
Figure 21. Three-Wire RS-485 Connections	34
Figure 22. 4-20 mA Output & Input Signal Powered by PD8-765-6X3-20	35
Figure 23. 4-20 mA Output Signal Powered by PD8-765-6X5-10	35
Figure 24. 4-20 mA Output Powered Externally	35
Figure 25. PD8-765-6X5-10 Powers Both the Heater Input Signal	35

Introduction

The ProtEX-MAX PD8-765 explosion-proof, large-display, process and temperature meter offers all the functionality of the PD765 Trident as a CSA, ATEX, and IECEx certified explosion-proof product. The PD8-765's huge 1.2" (30.5 mm) sunlight readable display is visible from over 30 feet away. This explosion-proof indicator can be field programmed to accept process voltage (0-5 V, 1-5 V, etc.) and current (4-20 mA) inputs, 100 Ohm RTDs, and the four most common thermocouples.

The intensity of the display can be adjusted to compensate for various lighting conditions, including direct sunlight. The meter can be programmed and operated without opening the housing by using the built-in CapTouch through-glass buttons or the RS-485 serial communication port with free Modbus protocol. Options for the PD8-765 process and temperature indicator include 2 relays, a 4-20 mA output, and a 24 V transmitter power supply.

CapTouch Buttons

To make it possible to program and operate the ProtEX-MAX in a hazardous area, the programming buttons that are located behind the glass window can be operated without removing the cover by using the CapTouch through-glass buttons. The operator puts their finger on the glass over the button and the button is actuated.



Ordering Information

Aluminum Enclosure

85-265 VAC Models

Model	Options Installed
PD8-765-6X0-10	24 VDC Transmitter Supply
PD8-765-6X3-20	4-20 mA Out Dual 24 VDC Transmitter Supplies
PD8-765-6X5-10	2 Relays 4-20 mA Output 24 VDC Transmitter Supply

12-36 VDC Models

Model	Options Installed
PD8-765-7X0-00	No options
PD8-765-7X5-00	2 relays 4-20 mA output

Stainless Steel Enclosure

85-265 VAC Models

Model	Options Installed
PD8-765-6X0-10-SS	24 VDC Transmitter Supply
PD8-765-6X3-20-SS	4-20 mA Out Dual 24 VDC Transmitter Supplies
PD8-765-6X5-10-SS	2 Relays 4-20 mA Output 24 VDC Transmitter Supply

12-36 VDC Models

Model	Options Installed
PD8-765-7X0-00-SS	No options
PD8-765-7X5-00-SS	2 relays 4-20 mA output

Accessories

Model	Description
PDA7420	PD8-765 Copy Cable, 7' (2.1 m)
PDA8006*	USB Serial Adapter for Programming Meter with MeterView Software
PDAPLUG75	3/4" Metal Conduit/Stopping Plug
PDA-SSTAG	Custom Stainless Steel Tag (see website for convenient ordering form)
PDA6848-SS	2" U-Bolt Kit Stainless Steel

*See [Free 8006](#) to receive PDA8006 at no charge.

Notes:

- 24 VDC transmitter supply available only on AC powered meters.
- RS-485 Communications is standard on all products

Helpful Videos

There are several videos that will help you get a better understating of the features and functionality of the ProtEX-MAX products. Since the PD8-765 meters have the same general features and functionality of the PD765 Trident meters, appropriate videos for the PD765 Trident meter are also included.

Programming a Thermocouple Input

This video details how to program a thermocouple input on a PD765 Trident Series meter.

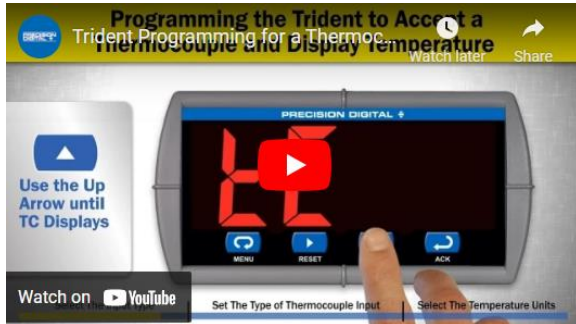

predig.com/Program_Trident_Thermocouple

PD765 Trident Display Advantages

The PD765 Trident digital panel meter's 1.2" LED display makes it the ideal choice when upgrading your panels. Watch this video and see real examples of the PD765 Trident improving existing panels with its huge display!



predig.com/videos/Trident_X2_Display_Advantages

PD765 Trident Demonstration

Watch this live demonstration of the PD765 Trident digital panel meter and see how it can improve your process. This video will show you the advantage of the large 1.2" display and simulate a level application.



predig.com/videos/Trident_X2_Live_Demo

MeterView Serial Communications

The PD765 Trident series is one of Precision Digital's most trusted and proven meters ever, and it now has new serial communications capabilities to make it easier to use than ever before. Watch this short video for more information.



predig.com/MV_Serial_Comm_PDA8006

Use ProtEX-MAX for Pump Control

Learn how to use the ProVu (ProtEX-MAX) meter as an explosion-proof pump controller. See how the four relays can be used to alternate two pumps and provide high and low alarms.



predig.com/videos/PumpControl

Key Features



Connections

PD8-765-6X5-10

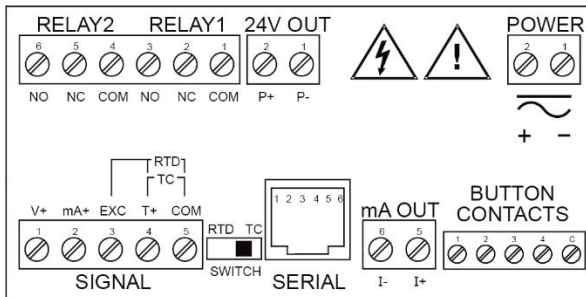

Two SPDT relays; 24 V transmitter power; TC, RTD, 4-20mA or 0-10 VDC inputs; 4-20 mA output; four external button contacts

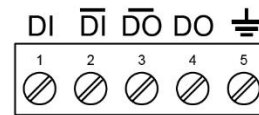

The ProtEX-MAX PD8-765 has a 5-position terminal block for connecting RS-485 serial devices.

The Only Explosion-Proof Process & Temperature Meter You Will Ever Need

The PD8-765 ProtEX-MAX is an explosion-proof version of the popular PD765 Trident process and temperature meter that can satisfy a wide variety of process applications. The PD8-765 can be field programmed to accept process voltage (0-5V, 1-5V, etc.) and current (4-20 mA) inputs, 100 Ohm RTDs, and the four most common thermocouples. It is housed in an explosion-proof, IP68, NEMA 4X aluminum or stainless steel enclosure, is certified by CSA as Explosion-Proof / Dust-Ignition-Proof / Flame-Proof, and is ATEX and IECEx certified as Dust-Ignition-Proof / Flame-Proof.

There are two power options for the ProtEX-MAX: 85 to 265 VAC or 12-36 VDC and the AC powered versions can provide 24 VDC to power the transmitter if needed. Programming and setup can be performed with the four CapTouch through-glass buttons, free MeterView software, or using the Copy function.

The relays and isolated 4-20 mA output option increases the utility of the PD8-765. The relays can be used for alarm or control applications. The 4-20 mA output provides an isolated retransmission of the input signal; especially useful for temperature inputs like thermocouples and RTDs. Now you can have an explosion-proof temperature transmitter with a huge, bright display!

The PD8-765 ProtEX-MAX display height is an astounding 1.2" (30.5 mm). It can be read easily from distances of up to 30 feet away! The display intensity function allows the selection of eight levels of intensity for various lighting conditions, including direct sunlight.

Easy Programming Methods

The PD8-765 is easily setup and programmed without removing the cover by using the four through-glass CapTouch buttons or by removing the cover and using the front panel push buttons. The meter can also be programmed using a PC and Precision Digital's free MeterView software or "cloned" with the Copy function. Programming the PD8-765 with MeterView software requires removing the front cover and connecting to the electronics module to the PC via the PDA8006 Trident USB serial adapter.

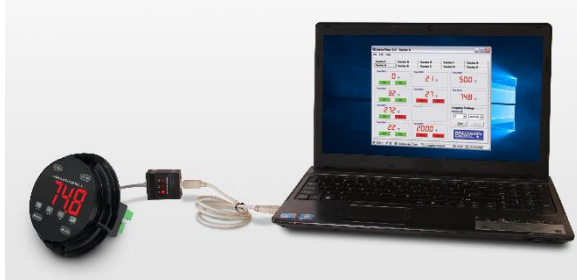

MeterView software allows all PD8-765 setup parameters to be programmed from a PC and to save the configuration settings to a file for reporting or programming other meters. For programming purposes, MeterView software connects to the PD8-765 meter via the low-cost PDA8006 USB serial adapter pictured above. We will even send you a PDA8006 USB adapter, normally sold for \$47.00, at no cost if you register your meter at <http://www.predig.com/free8006> (limit one per customer). You can program the PD8-765 you just bought with the front panel buttons and have the PDA8006 on hand for programming future meters.

Advanced Display Features

Super-Bright Display

The ProtEX-MAX comes standard with a super-bright display, with LEDs that are visible even in direct sunlight. The display also has up to eight levels of adjustable intensity for optimum visibility in any lighting condition.

Four Full Digits

The display on the PD8-765 is four full digits which means it can display numbers up to 9999. Many digital devices have displays of only 3½ digits which means they can display only to 1999. In practical terms, this means the PD8-765 can display type K thermocouples to 2300°F and 4-20 mA signals up to 9,999.

Front Panel LEDs

The meter is supplied with two alarm points that include front panel LEDs to indicate alarm conditions. This standard feature is particularly useful for alarm applications that require visual-only indication.

Large Display Size

The display height on the ProtEX-MAX PD8-765 is an astounding 1.2" (30.5 mm). It can be easily read from distances of up to 30 feet!

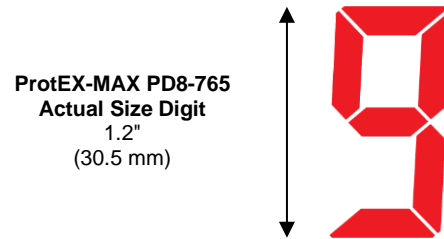

Meter Copy

The Copy function is used to copy (or clone) all the settings from one PD8-765 meter to other PD8-765 meters in less than 10 seconds. The Copy feature does not require a serial communication adapter, it only requires the optional cable assembly (PDA7420).



Note: The PD8-765 modules must be removed from the enclosures to connect the copy cable.

Display & Toggle Max / Min Reading

The main function of the front panel buttons during operation is to display the maximum and minimum readings reached by the process or temperature inputs. The PD8-765 allows you to toggle between the maximum and minimum readings of the process values. To display the maximum and minimum readings since the last reset/power-up, use the Up arrow/Max button.



Display & Toggle Maximum Value



Display & Toggle Minimum Value

Physical Features

The ProtEX-MAX is designed for ease-of-use in safe and hazardous area applications, and is housed in a rugged NEMA 4X explosion-proof enclosure, available in either aluminum or stainless steel. The PD8-765 can operate over a wide temperature range (-55 to 65°C / -67 to 149°F), includes removable screw terminal connectors, and features through-glass buttons for easy meter operation without the need to remove the cover. All of these features are backed by a 3-year warranty.

Super-Bright LED Display

The ProtEX-MAX features a 4-digit display with super-bright LEDs, our brightest ever. These allow the display to be read in any lighting condition, even in direct sunlight.



CapTouch Through-Glass Buttons

The ProtEX-MAX is equipped with four capacitive sensors that operate as through-glass buttons so that it can be programmed and operated without removing the cover (and exposing the electronics) in a hazardous area. These buttons can be disabled for security by selecting the DISABLE setting on the NO-CONTACT BUTTONS switch located on the back of the electronics module, inside the enclosure.

Rugged, Heavy-Duty Enclosure

The ProtEX-MAX is housed in a rugged NEMA 4X, 7, & 9, IP68 aluminum or stainless steel enclosure, designed to withstand harsh environments in safe and hazardous areas.



Wide Viewing Angle

Customers can't always look at the display from straight on, so the window and display module have been optimized to provide a wide viewing angle of approximately ± 40°; nearly twice that of the competition.



Built-In Mounting Flanges

The ProtEX-MAX is equipped with two slotted flanges for wall mounting or NPS 1½" to 2½" or DN 40 to 65 mm pipe mounting.



Flexible Mounting & Wiring

The ProtEX-MAX features four ¾" NPT threaded conduit openings so that wiring can be routed to the most convenient conduit connection(s).



Rotatable Display

The ProtEX-MAX rotatable display, along with four available conduit connections, provide for numerous installation options. The display can be rotated in 90° increments. Rotate it 90° for horizontal mounting.



Vertical Mounting

Horizontal Mounting

Perfect & Secure Fit Every Time

The internal cast rails ensure the ProtEX-MAX assembles together perfectly, quickly and securely; and everything lines up for optimal viewing every time. There are no standoffs to worry about breaking or getting out of alignment. The display module snaps into the built-in rails on the enclosure making assembly a snap, while pressing the display as close to the glass as possible to improve wide angle viewing. No tools are needed to install or remove it.

Stainless Steel Tags

PDA-SSTAG is a laser etched stainless steel tag accessory for any of your Precision Digital meters. The tag features custom text for equipment identification, instruction, or whatever else is needed in your facility. Each tag comes with a stainless steel wire and lead seal for easy mounting wherever you need it.



Removable Screw Terminals

Industrial applications require screw terminal connections for easy field wiring and the ProtEX-MAX goes one step further in convenience by also making them removable.

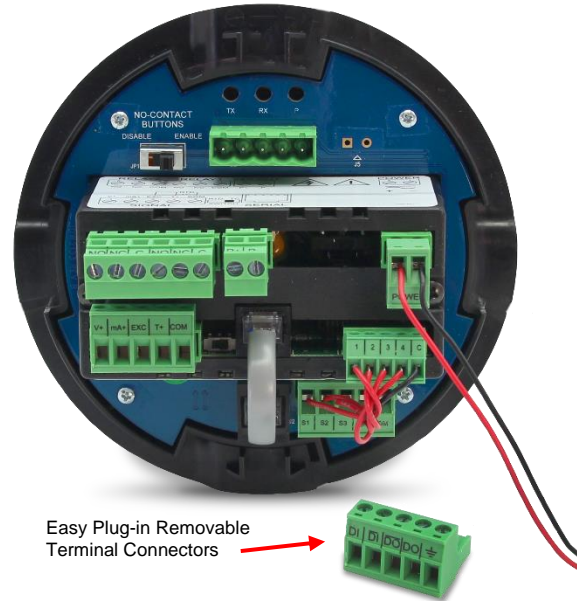

Easy Plug-in Removable Terminal Connectors

Note: The terminals on the External Contacts connector are wired to the connector on the electronics module to enable the CapTouch buttons so the meter can be programmed without removing the cover.

Program Meter from USB Port



Use the PDA8006 Trident USB Serial Adapter for Programming with MeterView

Hazardous Area Approvals

The ProtEX-MAX is certified by CSA as Explosion-Proof / Dust-Ignition-Proof / Flame-Proof, and is ATEX and IECEx certified as Dust-Ignition-Proof / Flame-Proof.

Wide Operating Temperature Range

The ProtEX-MAX can operate from -55 to 65°C (-67 to 149°F) meaning it can be installed in a wide variety of indoor and outdoor industrial applications.

Transmitter Power Supplies

Meter Powers Transmitter

One of the most useful features of AC powered PD8-765s is their built-in, isolated, 24 V @ 200 mA power supply to power the transmitter. This feature saves money by eliminating an external power supply and also simplifies wiring.

The following diagrams illustrate how to wire an AC powered PD8-765 so it will power the transmitter:

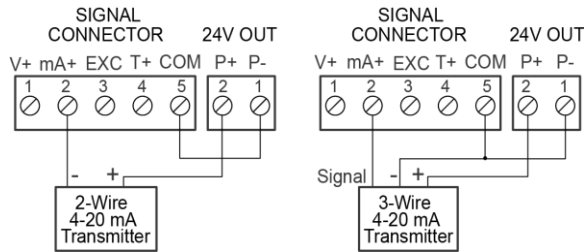

Connections for PD8-765-6X0-10 & PD8-765-6X5-10

Meter Powers 4-20 mA Output

Not only can the AC powered PD8-765 power the 4-20 mA input signal, but an additional power supply of 24 V @ 40 mA is available to power the 4-20 mA output.

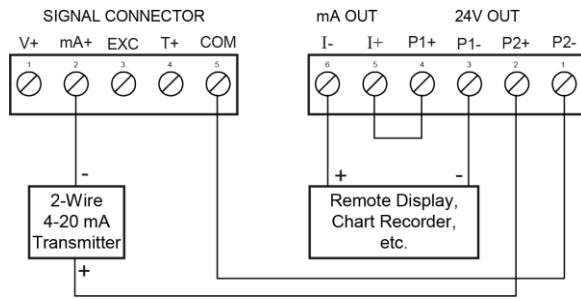

Connections for PD8-765-6X3-20

Isolated Transmitter Output

The PD8-765's isolated 4-20 mA output option converts the meter into a transmitter / loop isolator with a digital display; perfect for temperature applications!

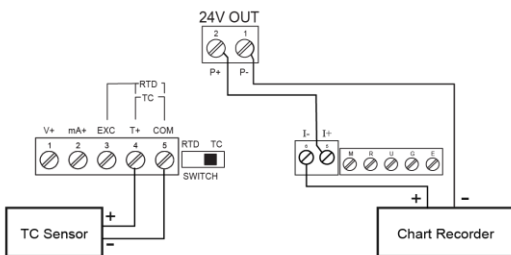

Fuse Prevents Current Overload

Another very useful aspect of the PD8-765 is that the current input is protected against current overload by a resettable fuse. The fuse limits the current to a safe level when it detects a fault condition, and automatically resets itself when the fault condition is removed.

Other Uses for Power Supplies

The most common use for these two power supplies is for the 200 mA transmitter power supply to power the field transmitter and 40 mA power supply to power the 4-20 mA output from the meter. However, these two power supplies can be used in other ways. For instance, some level transmitters require the use of a heated lens. The PD8-765's 200 mA power supply could be used to power both the heated lens and the 4-20 mA signal from the transmitter.

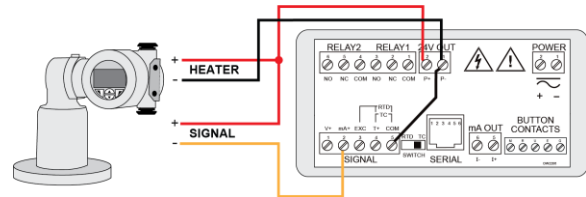

PD8-765-6X5-10 Powers Both the Heater and 4-20 mA Input Signal

External Power Supply for Loop

For applications that require an external transmitter power supply, the same PD8-765 is used and merely wired in a different fashion as the following diagrams illustrate:

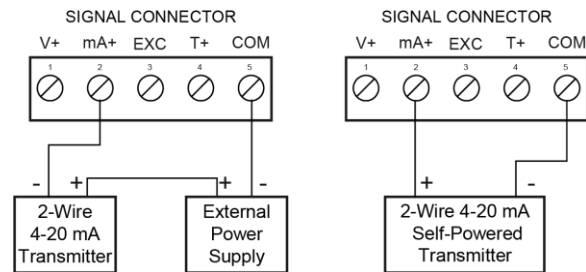

Exp-Proof Temperature Transmitter with Big Display

The PD8-765, with an optional 4-20 mA output, can be used as an isolated temperature transmitter with a big display by converting the thermocouple or RTD input into an isolated 4-20 mA output.

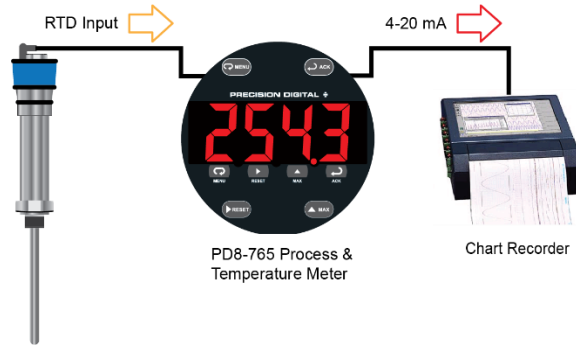

Input Signal Conditioning

To satisfy applications that require scaling in ways other than the usual 2-point linear method, the ProtEX-MAX can also be scaled for square root (DP flow).

Square Root Linearization

The square root function can be used to linearize the signal from a differential pressure transmitter and display flow rate in engineering units.

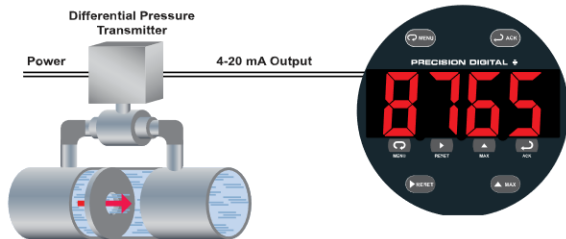

Exp-Proof Dual-Pump Alternation

The ProtEX-MAX can be used as an explosion-proof pump controller when combined with a continuous level transmitter. The most common pump control application is shown below: controlling and alternating two pumps. In addition, the ProtEX-MAX provides the 24 V to power the transmitter.

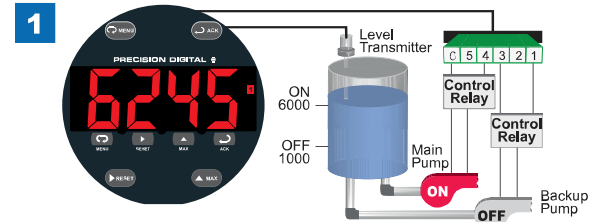

Relay #1 turns the main pump on at 6000 gallons and turns it off at 1000 gallons.

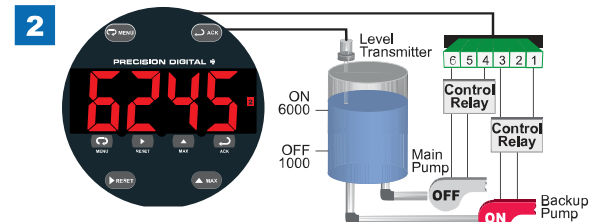

With the Pump Alternation feature activated, the next time the level reaches 6000 gallons, relay #2 starts the backup pump.

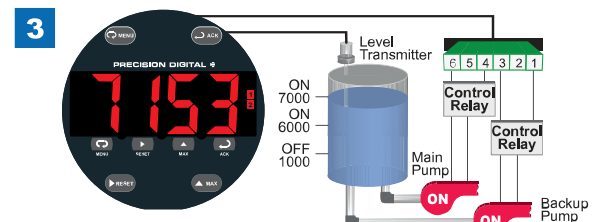

If the active pump is not able to keep up, and the level reaches 7000 gallons, the other relay will start the inactive pump as well.

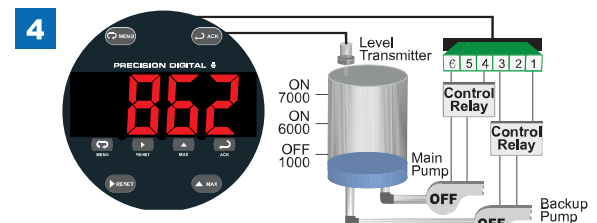

When the level falls below 1000 gallons, both pumps will turn off.



Learn how to use the PD765 Trident (ProtEX-MAX) meter as an explosion-proof pump controller. See how the four relays can be used to alternate two pumps and provide high and low alarms.

predig.com/videos/PumpControl

Useful Tools

PD9501 Multi-Function Calibrator



This [PD9501](#) Multi-Function Calibrator has a variety of signal measurement and output functions, including voltage, current, thermocouple, and RTD.

PD9502 Low-Cost Signal Generator



The [PD9502](#) is a low-cost, compact, simple to use 4-20 mA or 0-10 VDC signal generator. It can easily be set for 0-20 mA, 4-20 mA, 0-10 V or 2-10 V ranges. Signal adjustment is made with a one-turn knob. A 15-27 VDC wall plug is provided with the instrument. Optional USB power bank is available.

Specifications

Except where noted all specifications apply to operation at +25°C.

General

Display	1.20" (31 mm), red LED, Four digits (-1999 to 9999), automatic lead zero blanking.
Display Intensity	Eight user selectable intensity levels. Default intensity is six.
Display Update Rate	Process/RTD: 3.7-5/second Thermocouple: 1.8-2.5/second
LED Status Indicators	See <i>LED Status Indicators</i> on page 36 for details.
Overrange	Display flashes 9999
Underrange	Display flashes -1999
Programming Methods	Four CapTouch through-glass buttons when cover is installed. Mechanical buttons can be used with the cover removed. Cloning with Copy feature. Free PC-based USB MeterView programming software, and Modbus® registers.
Noise Filter	Programmable from 2 to 199 (0 will disable filter)
Filter Bypass	Programmable from 0.1 to 99.9% of calibrated span
Recalibration	All ranges are calibrated at the factory. Recalibration is recommended at least every 12 months.
Max/Min Display	Max/min readings reached by the process are stored until reset by the user or until power to the meter is turned off.
Password	Restricts modification of programmed settings
Non-Volatile Memory	All programmed settings are stored in non-volatile memory for a minimum of ten years if power is lost.
Power Options	85-265 VAC, 50/60 Hz; 90-265 VDC, 20 W max or 12-36 VDC; 12-24 VAC, 6 W max
Fuse	Required external fuse: UL Recognized, 5 A max, slow blow; up to 6 meters may share one 5 A fuse
Normal Mode Rejection	64 dB at 50/60 Hz
Isolation	4 kV input/output-to-power line 500 V input-to-output or output-to-P+ supply 6X5 models only: 100 V output-to-24 VDC supply
Overvoltage Category	Installation Overvoltage Category II: Local level with smaller transient overvoltages than Installation Overvoltage Category III
Environmental	T6 Class operating temperature range Ta = -55 to 60°C T5 Class operating temperature range Ta = -55 to 65°C Storage temperature range: -55 to 85°C (-67 to 185°F) Relative humidity: 0 to 90% non-condensing

Connections	Power, signal, relays, mA out: Removable screw terminal blocks accept 12 to 22 AWG wire RS-485: Removable screw terminal block accepts 16 to 30 AWG wire
Mounting	Wall Mounting: Four (4) mounting holes provided for mounting meter to wall. See <i>Wall Mounting Instructions</i> on page 22 for additional details. Pipe Mounting: Optional pipe mounting kit (PDA6848) allows for pipe mounting. Sold separately. See <i>Pipe Mounting Instructions</i> on page 23 for additional details.
Tightening Torque	Screw terminal connectors: 5 lb-in (0.56 Nm)
Overall Dimensions	6.42" x 7.97" x 8.47" (W X H X D) (163 mm x 202 mm x 215 mm)
Weight	Aluminum: 14.7 lbs (6.67 kg) Stainless Steel: 23.5 lbs (10.66 kg)
Warranty	3 years parts & labor. See Warranty Information and Terms & Conditions on www.predig.com for complete details.

Process Inputs

Inputs	0-20 mA, 4-20 mA, 1-5 V, ± 10 V						
Transmitter Supply	Isolated, one or two transmitter supplies P1: 24 VDC $\pm 10\%$ @ 200 mA max (-10 option) P1 & P2: 24 VDC $\pm 10\%$ @ 200 mA & 40 mA max (-20 option)						
Accuracy	$\pm 0.05\%$ FS ± 1 count; $\pm 0.1\%$ FS ± 2 counts for square root						
Function	Linear or square root						
Low-Flow Cutoff	0 to 9999 (0 disables cutoff function) Point below at which display always shows zero						
Decimal Point	Up to 3 decimals						
Calibration	Scale without signal or calibrate with signal source						
Calibration Range	User programmable over entire range of meter						
Input Impedance	Voltage range: greater than 1 M Ω , Current range: 50-100 Ω , varies with resettable fuse impedance						
Input Overload	Protected by automatically resettable fuse						
HART Transparency	The meter does not interfere with existing HART communications; it displays the 4-20 mA primary variable and it allows the HART communications to pass through without interruption. The meter is not affected if a HART communicator is connected to the loop. The meter does not display secondary HART variables.						
Temperature Drift	<table border="1"> <tr> <td>0 to 65°C ambient</td> <td>-40 to 0°C ambient</td> </tr> <tr> <td>Current: $\pm 0.20\%$ FS (50 PPM/°C)</td> <td>Current: $\pm 0.80\%$ FS</td> </tr> <tr> <td>Voltage: $\pm 0.02\%$ FS (1.7 PPM/°C)</td> <td>Voltage: $\pm 0.06\%$ FS</td> </tr> </table>	0 to 65°C ambient	-40 to 0°C ambient	Current: $\pm 0.20\%$ FS (50 PPM/°C)	Current: $\pm 0.80\%$ FS	Voltage: $\pm 0.02\%$ FS (1.7 PPM/°C)	Voltage: $\pm 0.06\%$ FS
0 to 65°C ambient	-40 to 0°C ambient						
Current: $\pm 0.20\%$ FS (50 PPM/°C)	Current: $\pm 0.80\%$ FS						
Voltage: $\pm 0.02\%$ FS (1.7 PPM/°C)	Voltage: $\pm 0.06\%$ FS						

Temperature Inputs

Inputs	Factory calibrated, field selectable: type J, K, T, or E thermocouples and 100 Ω platinum RTD (0.00385 or 0.00392 curve)																																	
Resolution	1°; type T TC & RTD: 1° or 0.1°																																	
Cold Junction Reference	Automatic																																	
Temperature Drift	$\pm 2^\circ\text{C}$ maximum																																	
Offset Adjustment	Programmable to $\pm 19.9^\circ$. This parameter allows the user to apply an offset value to the temperature being displayed.																																	
Input Impedance	Greater than 100 k Ω																																	
Accuracy	<table border="1"> <thead> <tr> <th>Input Type</th> <th>Range</th> <th>Accuracy (0 - 65 C)</th> <th>Accuracy (-40 - 0 C)</th> <th>Resolution</th> </tr> </thead> <tbody> <tr> <td>J</td> <td>-58 to 1382°F -50 to 750°C</td> <td>$\pm 2^\circ\text{F}$ $\pm 1^\circ\text{C}$</td> <td>$\pm 5^\circ\text{F}$ $\pm 3^\circ\text{C}$</td> <td>1°</td> </tr> <tr> <td>K</td> <td>-58 to 2300°F -50 to 1260°C</td> <td>$\pm 2^\circ\text{F}$ $\pm 1^\circ\text{C}$</td> <td>$\pm 4^\circ\text{F}$ $\pm 2^\circ\text{C}$</td> <td>1°</td> </tr> <tr> <td>T</td> <td>-292 to 700°F -180 to 371°C</td> <td>$\pm 2^\circ\text{F}$ $\pm 1^\circ\text{C}$</td> <td>$\pm 13^\circ\text{F}$ $\pm 7^\circ\text{C}$</td> <td>1° or 0.1°</td> </tr> <tr> <td>E</td> <td>-58 to 1700°F -50 to 927°C</td> <td>$\pm 2^\circ\text{F}$ $\pm 1^\circ\text{C}$</td> <td>$\pm 11^\circ\text{F}$ $\pm 6^\circ\text{C}$</td> <td>1°</td> </tr> <tr> <td>RTD</td> <td>-328 to 1382°F -200 to 750°C</td> <td>$\pm 1^\circ\text{F}$ $\pm 1^\circ\text{C}$</td> <td>$\pm 5^\circ\text{F}$ $\pm 3^\circ\text{C}$</td> <td>1° or 0.1°</td> </tr> </tbody> </table>				Input Type	Range	Accuracy (0 - 65 C)	Accuracy (-40 - 0 C)	Resolution	J	-58 to 1382°F -50 to 750°C	$\pm 2^\circ\text{F}$ $\pm 1^\circ\text{C}$	$\pm 5^\circ\text{F}$ $\pm 3^\circ\text{C}$	1°	K	-58 to 2300°F -50 to 1260°C	$\pm 2^\circ\text{F}$ $\pm 1^\circ\text{C}$	$\pm 4^\circ\text{F}$ $\pm 2^\circ\text{C}$	1°	T	-292 to 700°F -180 to 371°C	$\pm 2^\circ\text{F}$ $\pm 1^\circ\text{C}$	$\pm 13^\circ\text{F}$ $\pm 7^\circ\text{C}$	1° or 0.1°	E	-58 to 1700°F -50 to 927°C	$\pm 2^\circ\text{F}$ $\pm 1^\circ\text{C}$	$\pm 11^\circ\text{F}$ $\pm 6^\circ\text{C}$	1°	RTD	-328 to 1382°F -200 to 750°C	$\pm 1^\circ\text{F}$ $\pm 1^\circ\text{C}$	$\pm 5^\circ\text{F}$ $\pm 3^\circ\text{C}$	1° or 0.1°
Input Type	Range	Accuracy (0 - 65 C)	Accuracy (-40 - 0 C)	Resolution																														
J	-58 to 1382°F -50 to 750°C	$\pm 2^\circ\text{F}$ $\pm 1^\circ\text{C}$	$\pm 5^\circ\text{F}$ $\pm 3^\circ\text{C}$	1°																														
K	-58 to 2300°F -50 to 1260°C	$\pm 2^\circ\text{F}$ $\pm 1^\circ\text{C}$	$\pm 4^\circ\text{F}$ $\pm 2^\circ\text{C}$	1°																														
T	-292 to 700°F -180 to 371°C	$\pm 2^\circ\text{F}$ $\pm 1^\circ\text{C}$	$\pm 13^\circ\text{F}$ $\pm 7^\circ\text{C}$	1° or 0.1°																														
E	-58 to 1700°F -50 to 927°C	$\pm 2^\circ\text{F}$ $\pm 1^\circ\text{C}$	$\pm 11^\circ\text{F}$ $\pm 6^\circ\text{C}$	1°																														
RTD	-328 to 1382°F -200 to 750°C	$\pm 1^\circ\text{F}$ $\pm 1^\circ\text{C}$	$\pm 5^\circ\text{F}$ $\pm 3^\circ\text{C}$	1° or 0.1°																														

Relays Option

Rating	2 Form C (SPDT); rated 3 A @ 30 VDC or 3 A @ 250 VAC resistive load; 1/14 HP (\approx 50 watts) @ 125/250 VAC for inductive loads such as contactors, solenoids, etc.
Deadband	0-100% FS, user selectable
Electrical Noise Suppression	A snubber should be connected to each relay contact switching inductive loads to prevent disruption to the microprocessor's operation. Recommended snubber value: 0.01 μ F/470 Ω , 250 VAC (PDX6901).
High or Low Alarm	User may program any alarm for high or low
Relay Operation	<ul style="list-style-type: none"> Automatic (non-latching) and/or manual reset Latching (requires manual acknowledge) with/without clear Pump alternation control Off (disable unused relays)
Relay Reset	Front panel button, terminal at back of meter or through serial communications
Time Delay	0 to 199 seconds, on and off delays; programmable
Sensor Break Relay Operation	The sensor break relay condition may be programmed for each relay as On (alarm) or Off (non-alarm). The relays will enter these states when a sensor break is detected for RTD or thermocouple inputs. These settings have no effect when current or voltage inputs are selected.
Fail-Safe Operation	Programmable, independent for each relay. Relay coils are energized in non-alarm condition. In case of power failure, relays will go to alarm state.
Auto Initialization	When power is applied to the meter, relays will reflect the state of the input to the meter.

External Button Contacts

Number	Four
Function	Remote operation of front-panel buttons: programming, reset relays or view/reset max/min readings
Open State	+5 VDC open contact on button input terminals
Closed State	Closed contact button input terminal to common/ground, active low 0 to 0.4 VDC

Isolated 4-20 mA Transmitter Output Option

Scaling Range	1.00 to 23.00 mA; reverse scaling allowed									
Calibration	Factory calibrated for 4-20 mA									
Accuracy	\pm 0.1% FS \pm 0.004 mA									
Temperature Drift	50 PPM/ $^{\circ}$ C <i>Note: Analog output drift is separate from input drift.</i>									
Isolation	500 V input-to-output or output-to-24 VDC supplies 4 kV output-to-power line For -6X5 models only: 100 V output-to-24 VDC supply									
External Power	35 VDC maximum									
Output Loop Resistance	<table border="1"> <thead> <tr> <th>Power supply</th> <th>Minimum</th> <th>Maximum</th> </tr> </thead> <tbody> <tr> <td>24 VDC</td> <td>10 Ω</td> <td>700 Ω</td> </tr> <tr> <td>35 VDC (external)</td> <td>100 Ω</td> <td>1200 Ω</td> </tr> </tbody> </table>	Power supply	Minimum	Maximum	24 VDC	10 Ω	700 Ω	35 VDC (external)	100 Ω	1200 Ω
Power supply	Minimum	Maximum								
24 VDC	10 Ω	700 Ω								
35 VDC (external)	100 Ω	1200 Ω								

RS-485 Serial Communications

Compatibility	EIA-485
Connectors	Removable screw terminal connector
Max Distance	3,937' (1,200 m) max
Status Indication	Separate LEDs for Power (METER LINK), Transmit (TX), and Receive (RX)

Modbus RTU Serial Communications

Slave Id	1 – 247 (Meter address)
Baud Rate	300 – 19,200 bps
Transmit Time Delay	Programmable between 0 and 199 ms
Data	8 bit (1 start bit, 1 stop bit)
Parity	None (1 or 2 stop bits), even, or odd (Modbus [®] only; PDC protocol does not use parity)
Byte-To-Byte Timeout	0.01 – 2.54 second
Turn Around Delay	Less than 2 ms (fixed)

Note: Refer to the ProtEX-MAX Modbus[®] Register Tables located at www.predig.com for details.

Enclosure

Material	AL Models: ASTM A413 LM6 die-cast aluminum, copper-free, enamel coated SS Models: ASTM A743 CF8M investment-cast 316 stainless steel
Gasket	Fluoroelastomer
Rating	NEMA 4X, IP68 Explosion-proof
Color	AL: Blue SS: Silver
Window	Borosilicate glass
Conduits	Four 3/4" NPT threaded conduit openings
Conduit Stopping Plugs	Sold separately
Flanges	Two built-in flanges for wall and pipe mounting
Tamper-Proof Seal	Cover may be secured with tamper-proof seal
Overall Dimensions	6.42" x 7.97" x 8.47" (W x H x D) (163 mm x 202 mm x 215 mm)
Weight	AL: 14.7 lbs (6.67 kg) SS: 23.5 lbs (10.66 kg)
ATEX	Ⓔ II 2 G D Ex db IIC Gb Ex tb IIIC Db IP66/IP68 Tamb: -55°C to +85°C Certificate No.: Sira 19ATEX1252U
IECEX	Ex db IIC Gb Ex tb IIIC Db IP66/IP68 Tamb: -55°C to +85°C Certificate No.: IECEX SIR 19.0075U
CSA	Class I, Division 1, Groups A, B, C, D Class II, Division 1, Group E, F, G Class III Ex db IIC Gb Ex tb IIIC Db Class I, Zone 1, AEx db IIC Gb Zone 21, AEx tb IIIC Db IP66/IP68/TYPE 4X Tamb: -55°C to +85°C Certificate No.: CSA19.80011200U
UL	Class I, Division 1, Groups A, B, C, D Class II, Division 1, Groups E, F, G Class III Class I, Zone 1, AEx db IIC Gb Zone 21, AEx tb IIIC Db Ex db IIC Gb Ex tb IIIC Db IP66/IP68/TYPE 4X Tamb: -55°C to +85°C Certificate Number: E518920

Note: The above approvals are for the enclosure only. See next column for approvals on the entire instrument.

General Compliance Information

Electromagnetic Compatibility

Emissions	EN 55022 Class A ITE emissions requirements
Radiated Emissions	Class A
AC Mains Conducted Emissions	Class A
Immunity	EN 61326-1 Measurement, control, and laboratory equipment EN 61000-6-2 EMC heavy industrial generic immunity standard
RFI - Amplitude Modulated	80 -1000 MHz 10 V/m 80% AM (1 kHz) 1.4 - 2.0 GHz 3 V/m 80% AM (1 kHz) 2.0 - 2.7 GHz 1 V/m 80% AM (1 kHz)
Electrical Fast Transients	±2kV AC mains, ±1kV other
Electrostatic Discharge	±4kV contact, ±8kV air
RFI - Conducted	10V, 0.15-80 MHz, 1kHz 80% AM
AC Surge	±2kV Common, ±1kV Differential
Surge	1KV (CM)
Power-Frequency Magnetic Field	30 A/m 70%V for 0.5 period
Voltage Dips	40%V for 5 & 50 periods 70%V for 25 periods
Voltage Interruptions	<5%V for 250 periods

Product Ratings and Approvals

CSA	Class I, Division 1, Groups B, C, D Class II, Division 1, Groups E, F, G Class III, Division 1, T5 Class III, Division 1, T6 (Ta max = 60°C) Ex db IIC T5 Ex db IIC T6 (Ta max = 60°C) Ex tb IIIC T90°C Ta = -55°C to +65°C Enclosure: Type 4X & IP66 / IP68 CSA Certificate: CSA 12 2531731
ATEX	Ⓢ II 2 G D Ex db IIC T* Gb Ex tb IIIC T90°C Db IP68 Ta = -55°C to +*°C *T6 = -55°C to +60°C *T5 = -55°C to +65°C Certificate Number: Sira 12ATEX1182X
IECEX	Ex db IIC T* Gb Ex tb IIIC T90°C Db IP68 Ta = -55°C to +*°C *T6 = -55°C to +60°C *T5 = -55°C to +65°C Certificate Number: IECEX SIR 12.0073X

ATEX/IECEX Specific Conditions of Use:

1. The equipment label and epoxy coating may generate an ignition-capable level of electrostatic charges under certain extreme conditions. The user should ensure that the equipment is not installed in a location where it may be subjected to external conditions (such as high-pressure steam) which might cause a build-up of electrostatic charges on non-conducting surfaces. Additionally, cleaning of the equipment should be done only with a damp cloth.
2. Flameproof joints are not intended to be repaired.
3. All entry closure devices shall be suitably certified as "Ex d", "Ex t" and "IP66/68" as applicable. Suitable thread sealing compound (non-setting, non-insulating, non-corrosive, not solvent based, suitable for the ambient rating) must be used at the NPT conduit entries to achieve the IPx8 rating while maintaining the Ex protection concept.

Year of Construction

This information is contained within the serial number with the first four digits representing the year and month in the YYMM format.

For European Community: The ProtEX-MAX must be installed in accordance with the ATEX directive 2014/34/EU, and the product certificate Sira 12ATEX1182X.

EU Declaration of Conformity

For shipments to the EU and UK, a Declaration of Conformity was printed and included with the product. For reference, a Declaration of Conformity is also available on our website www.predig.com/docs.

Safety Information

⚠ CAUTION

- Read complete instructions prior to installation and operation of the meter.

⚠ WARNINGS

- Risk of electric shock or personal injury.
- Hazardous voltages exist within enclosure. Installation and service should be performed only by trained service personnel.
- Service requiring replacement of internal components must be performed at the factory.
- In hazardous areas, conduit and conduit/stopping plugs require the application of non-setting (solvent free) thread sealant. It is critical that all relevant hazardous area guidelines be followed for the installation or replacement of conduit or plugs.

Installation

Install in accordance with applicable local and national regulations (e.g. NEC).

For Installation in USA

The ProtEX-MAX must be installed in accordance with the National Electrical Code (NEC) NFPA 70.

For Installation in Canada

The ProtEX-MAX must be installed in accordance with the Canadian Electrical Code CSA 22.1. All power supplies below 36 V and all signal input circuits must be supplied from a CSA Certified Class 2 source.

For European Community

The ProtEX-MAX must be installed in accordance with the ATEX directive 2014/34/EU and the product certificate Sira 12ATEX1182X.

⚠ WARNINGS

- Disconnect from supply before opening enclosure.
- Keep cover tight while circuits are live.
- Conduit seals must be installed within 18" (450mm) of the enclosure.
- Use suitably certified and dimensioned cable entry device and/or plug.
- Cable must be suitable for 90°C.

Wiring connectors are accessed by opening the enclosure. To access electrical connectors, remove the electronics module. Connectors are on the rear of the electronics module.

Unpacking

Remove the meter from box. Inspect the packaging and contents for damage. Report damages, if any, to the carrier.

If any part is missing or the meter malfunctions, please contact your supplier or the factory for assistance.

Cover Jam Screw



The cover jam screw should be properly installed once the meter has been wired and tested in a safe environment. The cover jam screw is intended to prevent the removal of the meter cover in a hazardous environment without the use of tools. Using a M2 hex wrench, turn the screw clockwise until the screw contacts the meter. Turn the screw an additional 1/4 to 1/2 turn to secure the cover.

⚠ CAUTION

- Excess torque may damage the threads, screw head, and wrench.

Mounting

The ProtEX-MAX has two slotted mounting flanges that may be used for pipe mounting or wall mounting. Refer to *Figure 1* and *Figure 2* below.

⚠ WARNING

- Do not attempt to loosen or remove flange bolts while the meter is in service.

Mounting Dimensions

All units: inches (mm)

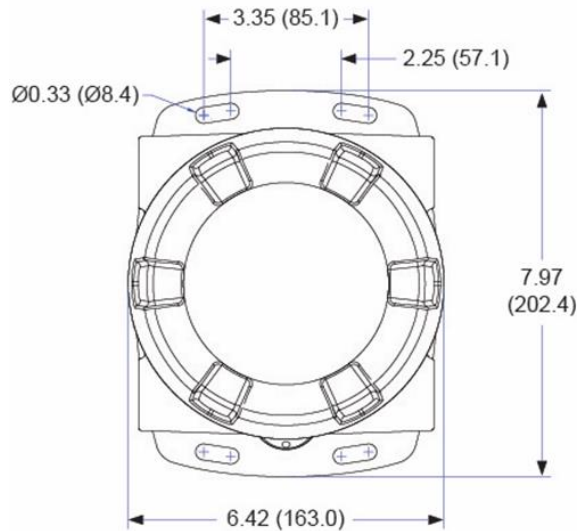

Figure 1. Enclosure Dimensions – Front View

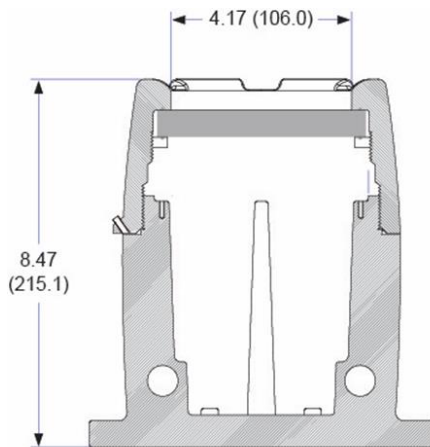

Figure 2. Enclosure Dimensions – Side Cross Section View

Wall Mounting Instructions

The meter can be mounted to any wall or flat surface using the four provided mounting holes located in the built-in flanges. In addition, the internal electronic assembly can be rotated to allow the enclosure to be mounted in any position. To mount the meter to a wall, follow these instructions:

- Prepare a section of wall approximately 7" x 8.5" (178 mm x 216 mm) for meter mounting by marking with a pencil the mounting holes (shown in *Figure 1*) on the wall.
- Select the appropriate mounting screws for the mounting surface to be used. The mounting holes diameter is shown on *Figure 1*.
Note: Mounting screws are not included.
- Using a drill bit slightly smaller than the girth of the mounting screws, pre-drill holes at the mounting locations previously marked.
- Insert mounting screws into the four mounting holes and screw them into the pre-drilled holes.

 Download free 3-D CAD files of these instruments to simplify your drawings!
predig.com/documentation-cad

Pipe Mounting Instructions



The meter can also be mounted to a pipe using an optional U-Bolt kit. This kit includes two U-bolts, the necessary hardware, and is available in 316 stainless steel ([PDA6848-SS](#)).



To mount the meter using a U-Bolt kit, follow these instructions:

- Orient the groove on the back of the instrument with the pipe and secure it to the pipe with the two U-bolts and hardware provided.



Vertical Pipe Mounting

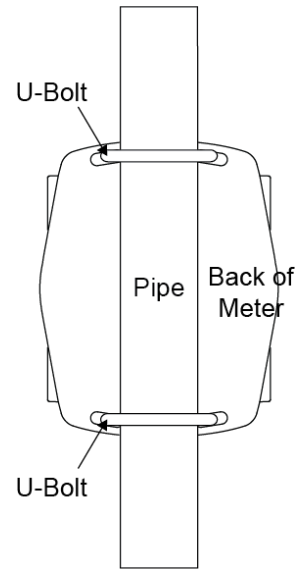

Horizontal Pipe Mounting

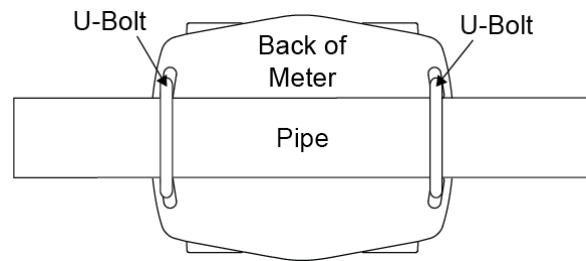

MeterView Software

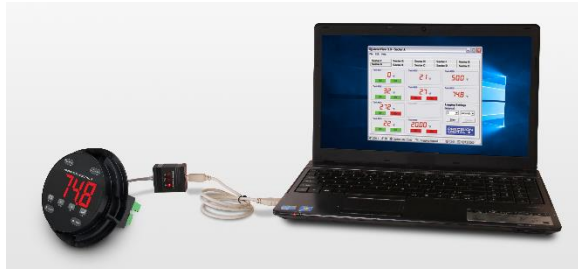

The easiest and quickest way to program your PD8-765 is to use the FREE MeterView software. We will even send you a PDA8006 USB adapter, normally sold for \$47.00, at no cost if you register your meter at <http://www.predig.com/free8006> (limit one per customer). You can program the PD8-765 you just bought with the front panel buttons and have the PDA8006 on hand for programming future meters.

Remote Programming

MeterView software allows all setup parameters to be programmed remotely from a PC and saved to a file for reporting or programming other meters.

Data Acquisition

MeterView software provides a convenient way to collect the data generated by the PD8-765 serial output. The user can select the logging time interval. Data can be written to a file, which can then be imported into a spreadsheet or other application.

Monitoring

MeterView software can be used to monitor up to 100 PD8-765s on a PC. The user can set a custom meter identification, such as Tank 1 to display on the screen as well as engineering units, such as feet. The screen shot below shows MeterView software monitoring level in six storage tanks:

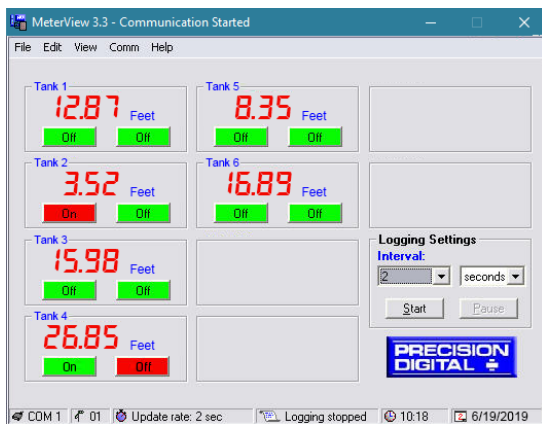

Monitoring System Parts

The following table illustrates the parts needed to monitor 10 PD8-765s:

Quantity	Model	Description
10	PDA7422	Trident RS-485 Serial Adapter
1	PDA8485-I	USB to RS-485 Isolated Converter

MeterView Installation

1. Go to www.predig.com/meterview
2. Read instructions & copy serial # of desired MeterView version
3. Download Installation file to computer
4. Double-click installation file to open it
5. Double-click **Setup.exe** to begin installation
6. Follow on-screen instructions

Running MeterView the First Time

The first time MeterView is run it is necessary to set up the serial communication settings of the program. Select the communication port and the baud rate of the meter(s) connected.

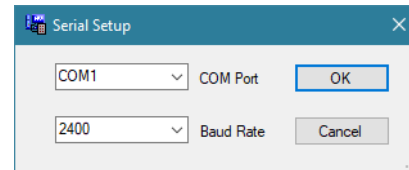

Note: The selected baud rate in MeterView and the meter(s) baud rate must be the same. Otherwise a communication error will occur.

⚠ WARNINGS

- Only one meter may be connected at a time. Attaching multiple meters will cause a conflict with the meter software.
- The meter should only be connected to a computer while it is located in a safe area.
- **DO NOT** unplug the meter while the new installation files are being written to it. The meter will display **u r t E** during the process and you will receive an on-screen notification once the process is complete.

Enable Meter and Select Meter Address

The actual meter address is set up at the meter using the front panel buttons. The location where a meter is displayed is selected on MeterView Main window. To enable or select a meter with a different serial address:

1. Right-click on the screen location of meter.
2. Click on **Enabled**, if meter is not yet enabled.
3. Click on **Change Address**.
4. Select meter address to display in this location.

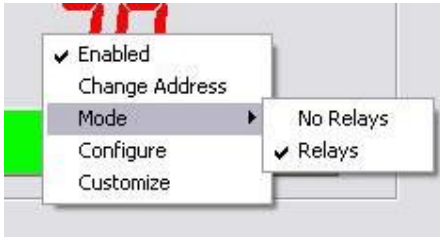

MeterView Main Window

The main MeterView window shows the present reading(s), relays/alarm status, tag number(s) and selected engineering units, along with other information for each meter. The graphic below indicates the different parts of the main MeterView window.

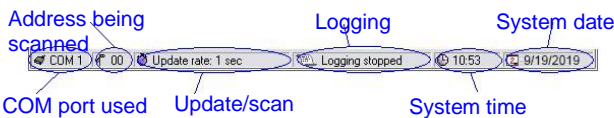
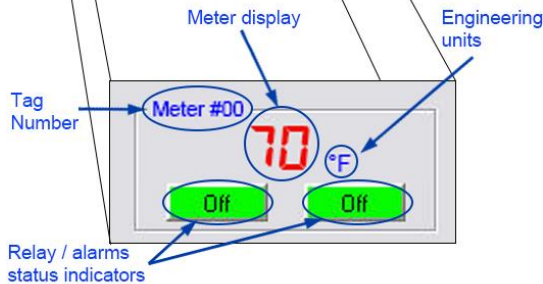
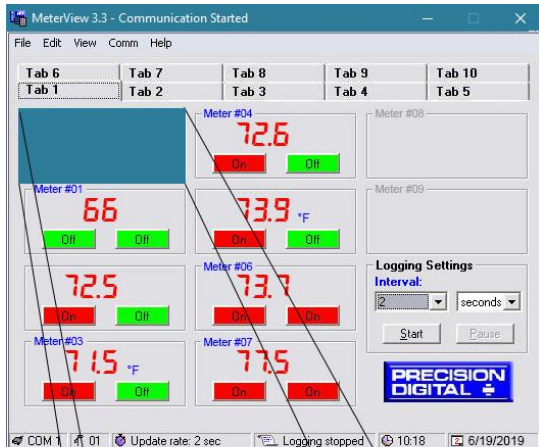

Main Window Menus

The MeterView main window contains the following menus:

- File menu
- Edit menu
- View menu
- Comm Menu
- Help Menu

File Menu

The following options are available from this menu:

1. **Exit** to close the MeterView program.

Edit Menu

The following options are available from this menu:

1. **Serial Settings** to edit the serial communication settings.
2. **Number of Meters** to automatically populate the Main Window with a single meter, 10 meters, or 100 meters.

View Menu

The following options are available from this menu:

1. **Event Log** to view the MeterView event log window where all internal program events and errors are logged.
2. **Show Relay Alerts** select whether or not MeterView should alert the user of a change in the relay status (ON → OFF or vice versa) with a pop-up message.

Comm Menu

The following options are available from this menu:

1. **Stop** to halt the automatic meter scanning. This allows quicker access to menu items, functions, and windows.
2. **Start** to resume the automatic meter scanning.

Help Menu

The following options are available from this menu:

1. **Online Resources** links to Predig.com for help and product documentation.
2. **About Meterview 3.3** for version number and build information.

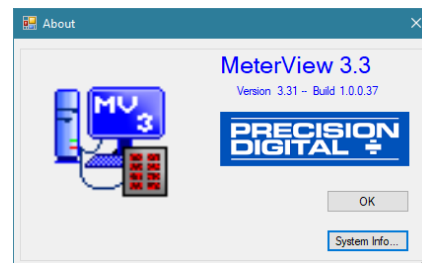

Right Click Menu

By right clicking on a meter on the screen a menu will appear with the following options:

Menu Item	Function/Submenus
Enabled	Enable or disable a meter on the screen
Change Address	Change a meter's serial address in MeterView
Mode	Show relays
Configure	Access the configuration window for a meter
Customize	Customize how a meter looks on the screen

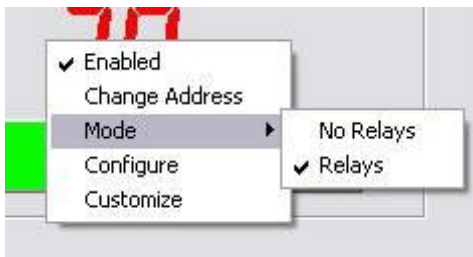

Notes:

- Accessing menus or other windows could disrupt communication with the meter(s).
- Use left mouse button or tab key on the keyboard to navigate within a window.
- Parameters not available within a window appear grayed-out.
- An arrow next to a box indicates a drop-down menu. Click on arrow to display the drop-down menu.

Configuration Window

Click on **Configure** in the right click menu to open a meter's configuration window. The following settings can be programmed from this window:

1. Input type (4-20 mA, 0-10 V, RTD, or TC).
2. Decimal point for process inputs (dd.dd).
3. Units (F or C) and sensor type for temperature inputs.
4. Values for scaling process inputs, values for scaling analog output, Password, Adjust (temperature only), Filter, Bypass, Cutoff (process inputs only), Transmit Delay, Function type, and Cut-off.
5. Relay settings.
6. After the last change has been made, click the **Write to Meter** button or press Enter on the keyboard to send the new settings to the meter, or click on **Exit** to abandon changes. Before sending the new settings, MeterView will ask to confirm that the meter's current settings should be overwritten. Click **Yes** to overwrite the settings, or **No** to abort the operation and return to the configuration window.

The configuration window contains the following menus:

- File menu
- Tools menu
- Password menu

Note: Accessing menus or other windows could disrupt communication with the other meter(s).

File Menu

The following options are available from the File menu:

1. **Save Configuration** to save the present settings to a file.
2. **Load Configuration** to load settings from a file.
3. **Export to HTML** to save the present settings to a HTML file.
4. **Import from HTML** to load settings from a HTML file.
5. **Print Configuration**

Tools Menu

The following options are available from the Tools menu:

1. **Load Defaults** to load the factory default settings.

It is recommended to save a configuration file before changing any setting and before any calibration operation.

Password Menu

The following options are available from the Password menu:

1. **Lock Meter** to lock the meter and prevent unauthorized changes.
2. **Unlock Meter** to unlock the meter and allow changes to be made.
3. **Change Password** to change the unlock password of the meter.

The password must be a four-digit number; "0000" is the unlocked password setting.

Input Tab

In the configuration window, click on the **Input** tab to view the input options.

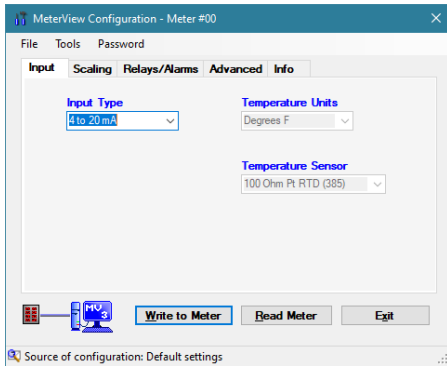

Set Up Input Type

Click on the arrow next to the *4 to 20 mA* box and then click on the desired input type.

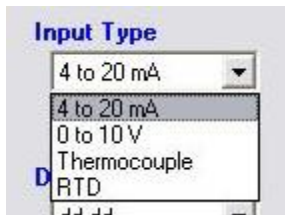

Set Up Decimal Point

Click on the arrow next to the *dd.dd* box and then click on the desired decimal point position. Decimal point selection is available for 4-20 mA and 0-10 V inputs only. The display scale and relay set/reset points are adjusted according to the decimal point selection.

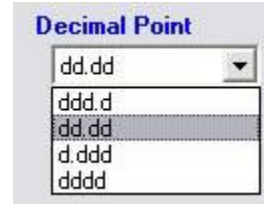

Set Up Temperature Unit

Click on the arrow next to the *Degrees F* box and then click on the desired temperature unit. Temperature unit selection is available for Thermocouple and RTD inputs only.

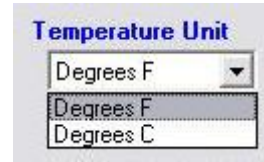

Set Up Temperature Sensor

Click on the arrow next to the *Type J* box and then click on the desired temperature sensor. Temperature sensor selection is available for Thermocouple and RTD inputs only.

Thermocouple Sensors

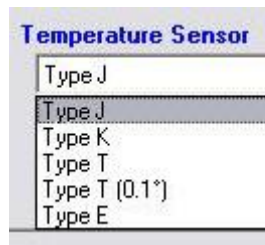

RTD Sensors

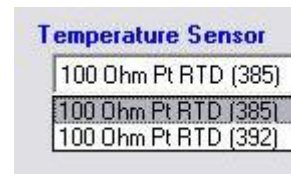

Scaling Tab

In the configuration window, click on the **Scaling** tab to view the scaling settings for process inputs (current and voltage).

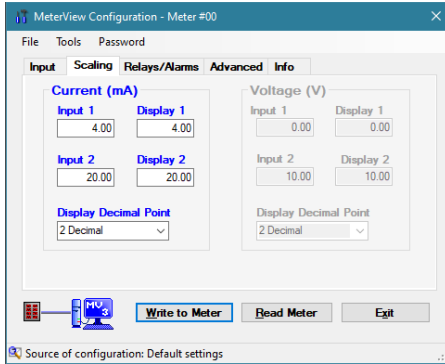

Info Tab

In the configuration window, click on the **info** tab to view the firmware number and version.

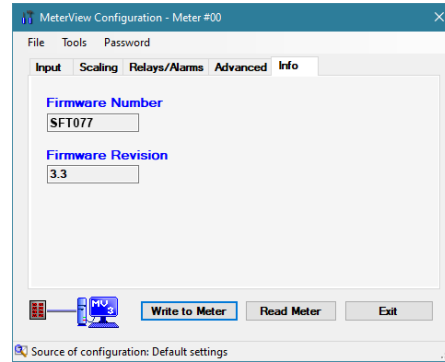

Relays/Alarms Tab

In the configuration window, click on the **Relays/Alarms** tab to view the settings for the relays/alarms.

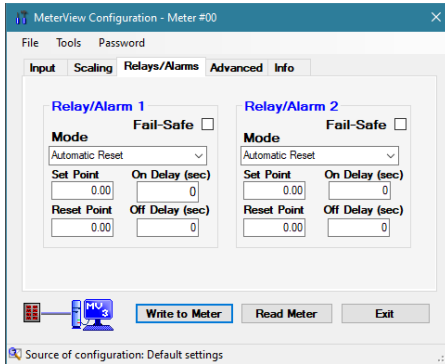

Customize Window

Click on **Customize** in the right click menu to open a meter's customize window. The following settings can be programmed from this window:

1. **Tag Number** to identify a meter and optionally display it on the meter. Pre-selected special characters may be used in this field by simply dragging the desired symbol into it.
2. **Display Units** to identify the engineering units of the value being read and optionally display it on the meter. Pre-selected special characters may be used in this field by simply dragging the desired symbol into it.
3. **Display Color** to change the color of the meter display on the screen.
4. **Relay Tag** to change the text label of the Relay Status indicator(s).
5. **Relay Color** to change the color of the Relay Status indicator(s).

Advanced Tab

In the configuration window, click on the **Advanced** tab to view the advanced settings. Consult the meter manual for further details.

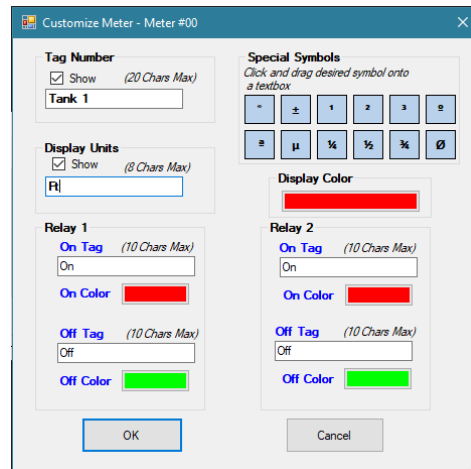
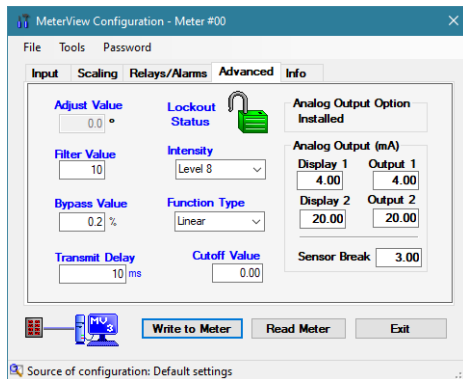

Note: These settings are **NOT** saved to the meter.

Serial Communication Setup

Addresses for PD8-765 and MeterView are set to 00 at the factory.

1. From the main window, click on **Edit → Serial Settings** menu to access the Serial Communication Setup.
2. Select correct communication port used for Serial Adapter.
3. If timeout error is received, try another serial port selection or check meter's address.

To change the serial address of a meter, simply click on **Change Address** in the right-click menu. This setting is on a per-meter basis.

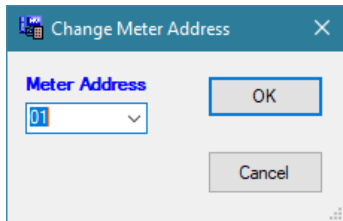

Note: Baud rate is set up for 2400 bps at the factory.

Relays/Alarms Status

Each meter enabled in the main MeterView window can display the current status of its relays/alarms (if the meter **Mode** in the right-click menu is set to **Relays**) and can allow the user to remotely acknowledge the relays/alarms (if applicable). The text labels and colors for the status indicators may be customized through the **Customize** window.

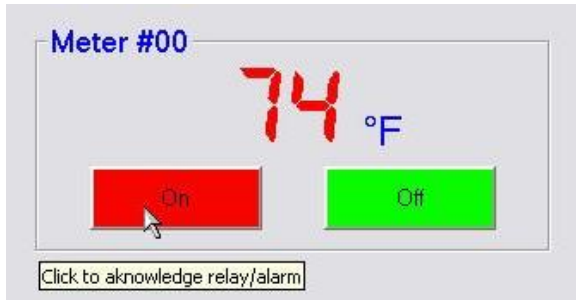

Logging Meter Data to File

1. Click on the arrow next to the Interval box to select an interval from 2 to 60 or select manual to log the data only when the **Log** button is clicked (**Log** button is only visible when manual is selected).
2. Select seconds, minutes, or hours.
3. Click the **Start** button.
4. Select file location and enter a file name. Click **OK**. MeterView will begin logging data to the file.

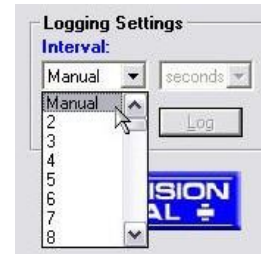

Logging may be paused or stopped at any time. MeterView will indicate logging and paused status with corresponding message flashing in the main window status bar. When logging, all other MeterView functions and windows are not accessible.

Log File Sample

The HTML log file format contains pertinent information related to the meter and logging selections. Each log entry includes date and time, tag number, serial address, display value, units and relays/alarms status.

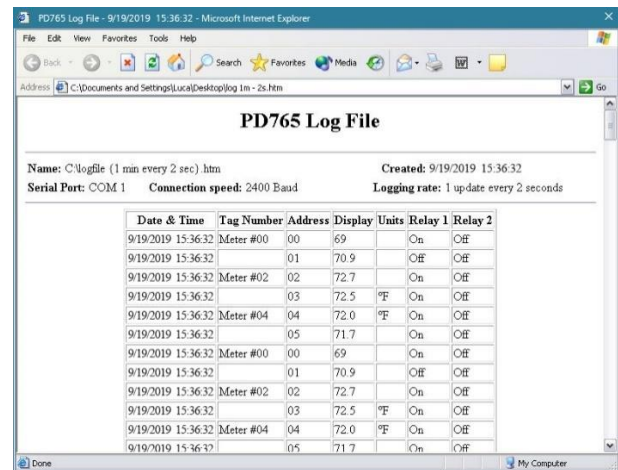

Connections

All connections are made to removable screw terminal connectors located at the rear of the meter.

CAUTION

- Use copper wire with 60°C or 60/75°C insulation for all line voltage connections. Observe all safety regulations. Electrical wiring should be performed in accordance with all applicable national, state, and local codes to prevent damage to the meter and ensure personnel safety.

WARNINGS

- Observe all safety regulations. Electrical wiring should be performed in accordance with all agency requirements and applicable national, state, and local codes to prevent damage to the meter and ensure personnel safety.
- Static electricity can damage sensitive components.
- Observe safe handling precautions for static-sensitive components.
- Use proper grounding procedures/codes.
- If the instrument is installed in a high voltage environment and a fault or installation error occurs, high voltage may be present on any lead or terminal.
- Follow all fusing and wiring precautions requirements for the instrument integrated to the PD8 Series model number being connected.

To access the connectors, remove the enclosure cover. The electronics module is snapped into the back of the enclosure and is removed by pulling it straight out. Signal connections are made to de-pluggable connectors on the back of the electronics module.

Some connectors may be provided already connected. These connections are required for proper operation of the ProtEX-MAX and should not be removed unless instructed to by this manual.

Grounding connections are made to the two ground screws provided on the base – one internal and one external.

After all connections have been completed and verified, apply power to the unit.

Required & Factory Wired Connection

The ProtEX-MAX comes with a pre-wired connection. This connection is detailed below and must be maintained in order for the instrument to function properly.

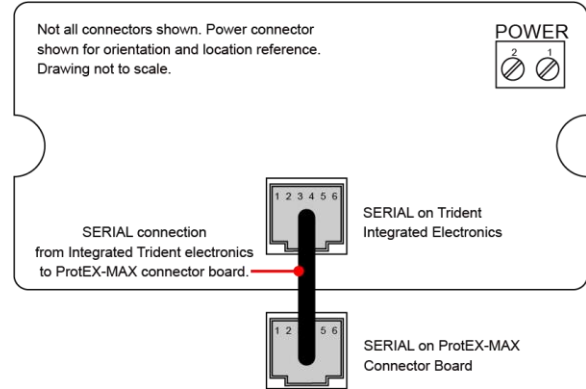

Figure 3: Integrated PD765 Trident Required Connections

PD765 Trident Electronics Module Layout for PD8-765-6X5-10

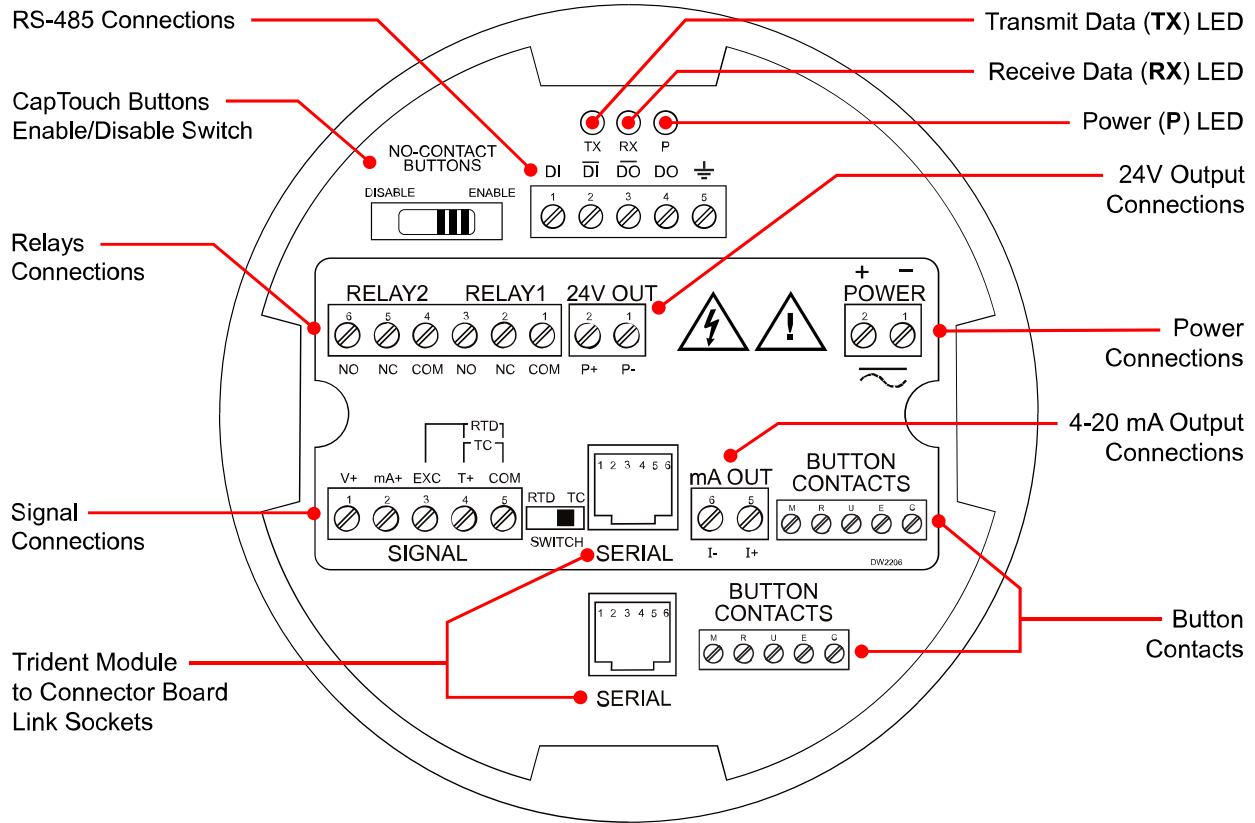

Figure 4. PD765 Trident Electronics Module Layout

Connector Labeling

The connectors label, affixed to the meter, shows the location of all connectors available with requested configuration. It also identifies the location of the RTD/TC selector switch. The images below (and one above) show all connector configurations for the PD8-765. Note that the connector in the upper left of the diagram has different configurations based on the model.

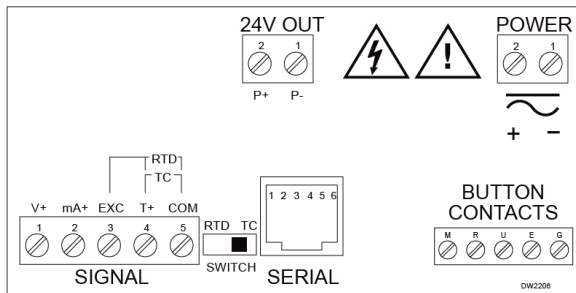

Figure 5. Connector Labeling for PD8-765-6X0-10

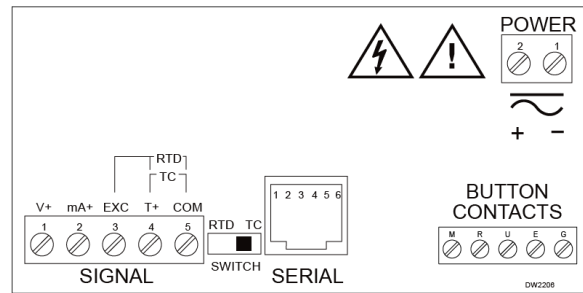

Figure 7. Connector Labeling for PD8-765-7X0-00

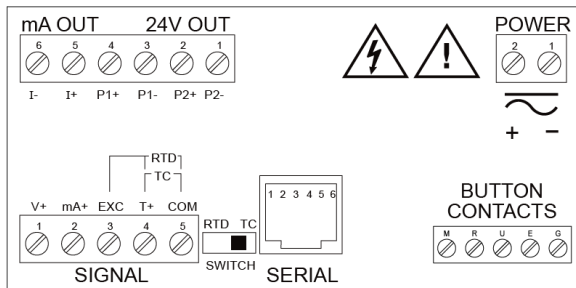

Figure 6. Connector Labeling for PD8-765-6X3-20

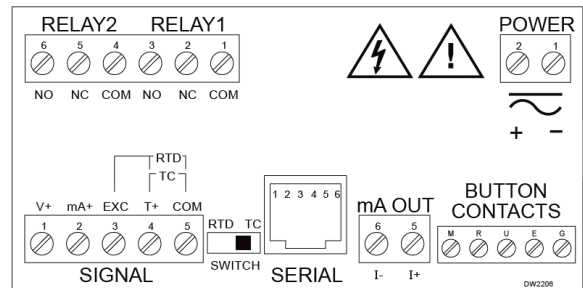

Figure 8. Connector Labeling for PD8-765-7X5-00

Power Connections

Power connections are made to a two-terminal connector labeled POWER on Figures 4-8. See *Connector Labeling* on page 31. The meter operates regardless of DC polarity. The + and - symbols are only a suggested wiring convention.

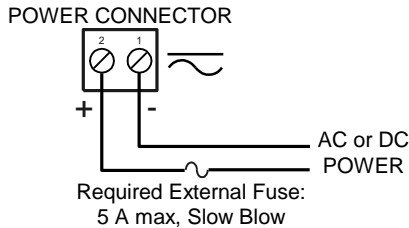

Figure 9. Power Connections

Signal Connections

Signal connections are made to a five-terminal connector labeled SIGNAL shown in Figures 4-8. See *Connector Labeling* on page 31. The COM (common) terminal is the return for all types of inputs.

Current and Voltage Connections

The following figures show examples for current and voltage connections. There are no switches or jumpers to set up for current and voltage inputs. Setup and programming is performed through the front panel buttons.

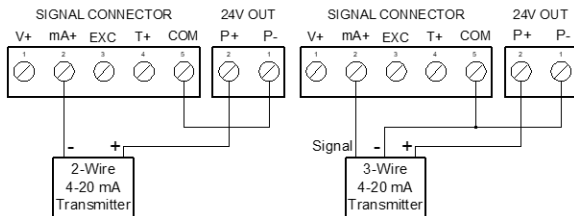

Figure 10. Transmitter Powered by Internal Supply (PD8-765-6X-10 and PD8-765-6X5-10)

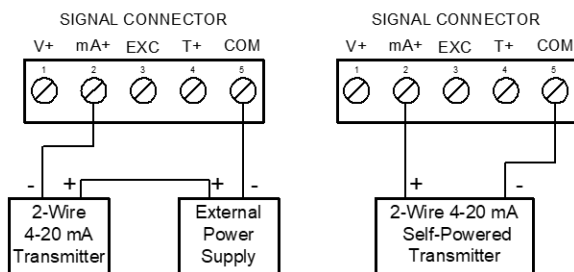

Figure 11. Transmitter Powered by External Supply or Self-Powered

The current input is protected against current overload by a resettable fuse. The display may or may not show a fault condition depending on the nature of the overload.

The fuse limits the current to a safe level when it detects a fault condition, and automatically resets itself when the fault condition is removed.

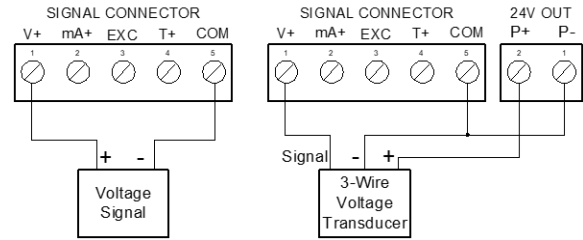

Figure 12. Voltage Input Connections

The meter is capable of accepting any voltage from -10 VDC to +10 VDC.

Thermocouple and RTD Connections

The following figures show examples for thermocouple and RTD connections. The RTD/TC selector switch must be set to the proper position for the meter to accept the selected temperature input.

The input type is selected using the *Setup* menu. The selected thermocouple input must correspond to the thermocouple sensor and wire type used.

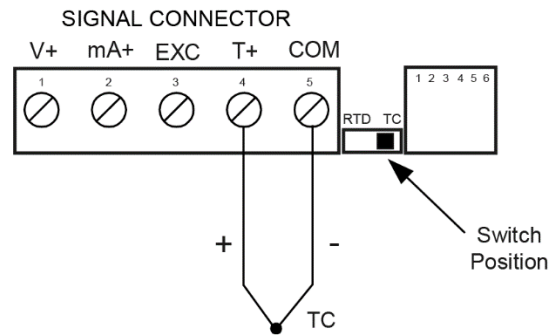

Figure 13. Thermocouple Input Connections

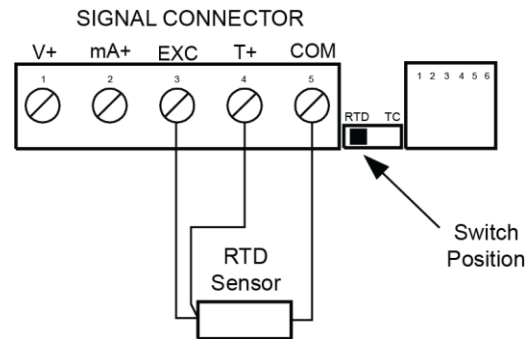

Figure 14. Three-Wire RTD Input Connections

The meter accepts two, three, or four-wire RTDs. The three-wire RTD connection has built-in lead wire compensation.

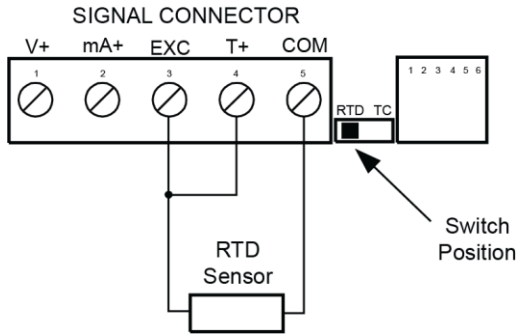

Figure 15. Two-Wire RTD Input Connections

Lead wire compensation for two-wire RTDs can be applied using the *Adjust* menu. See *Offset Adjustment (Adj)* on page 49.

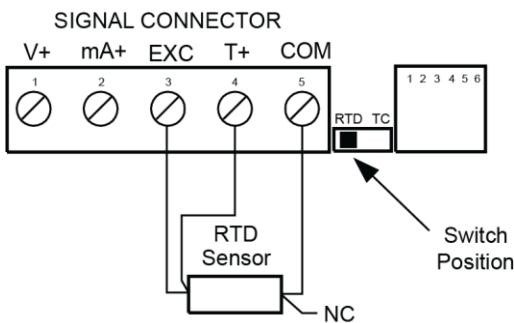

Figure 16. Four-Wire RTD Input Connections

The four-wire RTD connection is similar to the three-wire. One of the leads of a four-wire RTD is not connected and may be clipped off.

The three-wire connection provides sufficient lead wire compensation to provide accurate readings even with long leads.

RC Networks Available from Precision Digital

RC networks are available from Precision Digital and should be applied to each relay contact switching an inductive load. Part number: [PDX6901](#).

Note: Relays are de-rated to 1/14th HP (50 watts) with an inductive load.

Relays and 24 V Output Connections

Relay connections are made to a six-terminal connector labeled RELAY1, RELAY2. See *Connector Labeling* on page 31. The COM (common) terminals of the relays should not be confused with the COM (common) terminal of the SIGNAL connector. The 24 VDC output (available on AC powered units only) is available at the connector labeled 24V OUT, next to the relays connector.

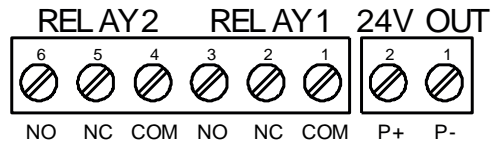

Figure 17. Relay & 24 V Output Connections

Switching Inductive Loads

The use of snubbers to suppress electrical noise is strongly recommended when switching inductive loads to prevent disrupting the microprocessor's operation. The snubbers also prolong the life of the relay contacts. Suppression can be obtained with resistor-capacitor (RC) networks assembled by the user or purchased as complete assemblies. Refer to the following circuits for RC network assembly and installation:

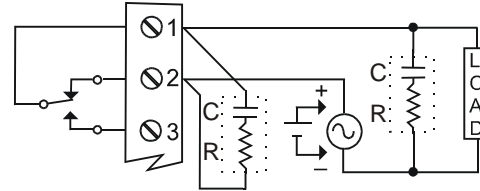

Figure 18. AC and DC Loads Protection

Choose R and C as follows:

- R: 0.5 to 1 Ω for each volt across the contacts
- C: 0.5 to 1 μF for each amp through closed contacts

Notes:

1. Inductive relay rating is 1/14 HP (50 W) at 115/230 VAC
2. Use capacitors rated for 250 VAC.
3. RC networks may affect load release time of solenoid loads. Check to confirm proper operation.
4. Install the RC network at the meter's relay screw terminals. An RC network may also be installed across the load. Experiment for best results.

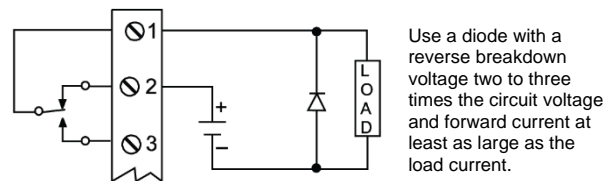

Use a diode with a reverse breakdown voltage two to three times the circuit voltage and forward current at least as large as the load current.

Figure 19. Low Voltage DC Loads Protection

RS-485 Connections



The RS-485 connections are made to a five terminal connector used for Modbus® RTU serial communications. The RS-485 terminals include Transmit Data (DO) and (/DO), Receive Data (DI) and (/DI), and Signal Ground. See *Serial Communications (SERL)* on page 50 for more information.

There are three diagnostic LEDs: Transmit Data (TX), Receive Data (RX) and METER LINK to show when the meter is transmitting and receiving data from other devices.



Figure 20. RS-485 Diagnostic LEDs

RS-485 Multi-Drop Connection

When using more than one meter in a multi-drop mode, each meter must be provided with its own unique address. The meter address (Slave ID) can be programmed between 1 and 247. The transmit delay can be set between 0 and 199 ms. The parity can be set to even, odd, or none with 1 or 2 stop bits.

To change the meter address:

1. Press and hold the Menu button for three seconds to access Advanced Features menu of the meter.
2. Press Up arrow until Serial (SERL) menu is displayed and press Enter, Addr is displayed.
3. Press Enter to change meter address using Right and Up arrow buttons. Press Enter to accept.
4. Press Menu button to exit and return to Run Mode.

Three-Wire Connections

In order to wire the five pins for use as a three-wire half-duplex RS-485 connection, it is necessary to create a jumper connection between DI to DO and /DI to /DO- as shown below.

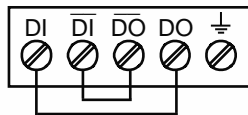
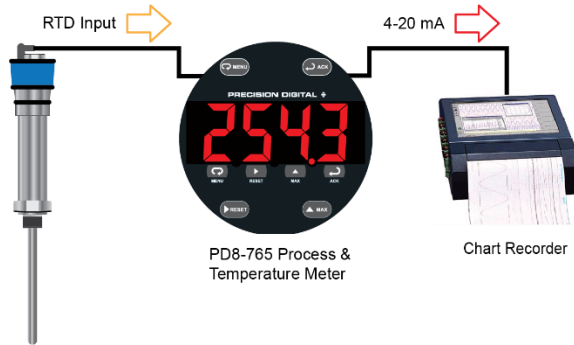

Figure 21. Three-Wire RS-485 Connections

4-20 mA Output & Input Signal Connections

The PD8-765, with an optional 4-20 mA output, can be used as an isolated temperature transmitter with a big display by converting the thermocouple or RTD input into an isolated 4-20 mA output.



Connections for the 4-20 mA transmitter output are made to the connector terminals labeled "mA OUT: I-, I+". The 4-20 mA output may be powered from an internal power supply (optional) or from an external power supply.

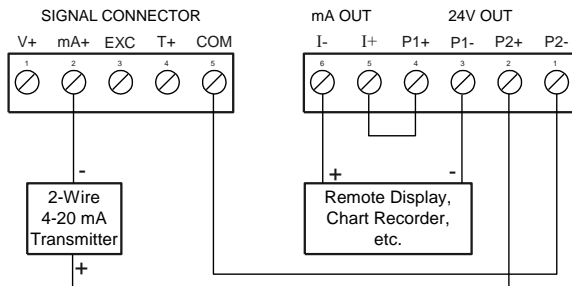

Figure 22. 4-20 mA Output & Input Signal Powered by PD8-765-6X3-20

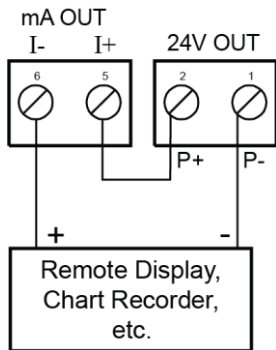

Figure 23. 4-20 mA Output Signal Powered by PD8-765-6X5-10

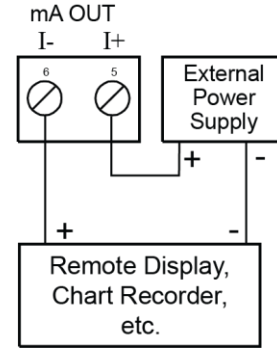

Figure 24. 4-20 mA Output Powered Externally

Models include PD8-765-6X3-00, PD8-765-7X3-00, PD8-765-7X5-00

Other Uses for Transmitter Power Supplies

The most common use for the PD8-765's two power supplies is for the 200 mA transmitter power supply to power the field transmitter and the other power supply to power the 4-20 mA output from the meter. However, the power supplies can be used in other ways. For instance, for level transmitters that require the use of a heated lens, the PD8-765's 200 mA power supply could be used to power both the heated lens and the 4-20 mA signal from the transmitter.

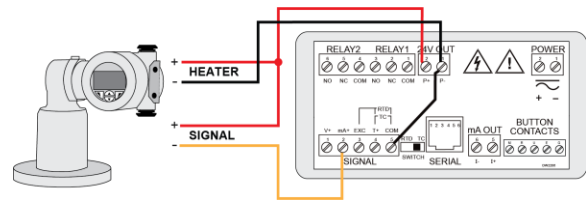
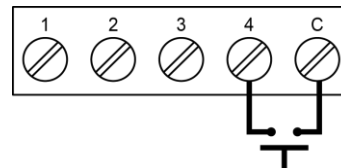

Figure 25. PD8-765-6X5-10 Powers Both the Heater and 4-20 mA Input Signal

External Button Contacts

The PD8-765 is equipped with four external button contacts that can be used to remotely operate the PD8-765's front panel buttons. For instance, these button contacts can be used to program the meter and to remotely acknowledge/reset the relays:



Terminal	Programming	Operation
M	Menu	
R	Right Arrow	Reset Max/Min
U	Up Arrow	Display Max/Min
E	Enter	Acknowledge Relays

Setup and Programming

There is **no need to recalibrate** the meter when first received from the factory. The meter is **factory calibrated** prior to shipment for milliamps and volts with calibration equipment that is certified to NIST standards.

Overview

There are no jumpers involved in the setup process of the meter. The RTD/TC selector switch, located between the SIGNAL and SERIAL connectors, must be set accordingly for the meter to accept RTD or thermocouple inputs. See Figures under *Connector Labeling* on page 31.

Setup and programming is done using MeterView or through the programming buttons.

After power and input signal connections have been completed and verified, apply power to the meter.









LED Status Indicators



LED	State	Indication
1	Steady	Alarm 1
2	Steady	Alarm 2

See *Quick Interface Reference Guide* on page 59

Programming Buttons

Button Symbol	Description
 	Press to enter or exit Programming Mode, view settings, or exit max/min readings
 	Press to reset max/min readings or other parameter/function assigned through the <i>User</i> menu
 	Press to display max/min readings or other parameter/function assigned through the <i>User</i> menu
 	Press to acknowledge relays or other parameters/function assigned through the <i>User</i> menu

- Press the Menu button to enter or exit the Programming Mode at any time.
- Press the Right arrow button to move to the next digit during digit or decimal point programming.
- Press or hold the Up arrow button to scroll through the menus, decimal point, or to increment the value of a digit.
- Press the Enter/Ack button to access a menu or to accept a setting.
- Press and hold the Menu button for three seconds to access the advanced features of the meter.

CapTouch Buttons

The ProtEX-MAX is equipped with four capacitive sensors that operate as through-glass buttons so that they can be operated without removing the cover (and exposing the electronics) in a hazardous area or harsh environment.

CapTouch buttons are designed to protect against false triggering and can be disabled for security by selecting DISABLE on the switch labeled NO-CONTACT BUTTONS located on the connector board.

To actuate a button, press one finger to the window directly over the marked button area. When the cover is removed or replaced, the CapTouch buttons can be used after the meter completes a self-calibrating routine. The sensors are disabled when more than one button is pressed, and they will automatically re-enable after a few seconds. When the cover is removed, the four mechanical buttons located on the right of the faceplate are used.

The CapTouch Buttons are configured by default to duplicate the function of the front panel mechanical pushbuttons associated with the integrated meter.

CapTouch Button Tips:

- Keep the glass window clean.
- Tighten the cover securely.
- Use a password to prevent tampering.



Display Functions and Messages

The meter displays various functions and messages during setup/programming and operation. The following table shows the displayed functions and messages with their action/setting description.

Display	Parameter	Action/Setting
SEtU	Setup	Enter Setup menu
INPt	Input	Enter Input menu
4-20	4-20 mA	Set meter for 4-20 mA input
0-10	0-10 VDC	Set meter for ±10 VDC input
rtd	RTD	Set meter for RTD input
R385	Alpha 385	Set α = 0.00385 European curve 100Ω RTD
R392	Alpha 392	Set α = 0.00392 American curve 100Ω RTD
tC	TC	Set meter for TC input
0 J	0 J	Type J
1 K	1 K	Type K
2 T	2 T	Type T
3 T.0	3 T.0	Type T, 0.1° resolution
4 E	4 E	Type E
F C	°F or °C	Set temperature scale
°F	°F	Set meter to Fahrenheit
°C	°C	Set meter to Celsius
dEcP	Decimal point	Set decimal point
PrOG	Program	Enter the Program menu
ScRL	Scale	Enter the Scale menu
CRl	Calibrate	Enter the Calibrate menu
INP 1	Input 1	Calibrate input 1 signal or program input 1 value
d IS 1	Display 1	Program display 1 value
INP 2	Input 2	Calibrate input 2 signal or program input 2 value
d IS 2	Display 2	Program display 2 value
Err	Error	Error, calibration not successful, check signal
rELy	Relay	Enter the Relay menu
rLY 1	Relay 1	Relay 1 setup
Rct 1	Action 1	Set relay 1 action (automatic, latching, etc.)
RuLo	Automatic	Set relay for automatic reset
R-nr	Auto-manual	Set relay for automatic + manual reset any time
LtCH	Latching	Set relay for latching operation
L-CL	Latching-cleared	Set relay for latching operation with manual reset only after alarm condition has cleared
RLEr	Alternate	Set relays for pump alternation control
oFF	Off	Disable relay and front panel status LEDs Disable relay's fail-safe operation
SEt 1	Set 1	Program set point 1
rSEt 1	Reset 1	Program reset point 1

Display	Parameter	Action/Setting
rLY 2	Relay 2	Setup relay 2
Rct 2	Action 2	Set relay 2 action (automatic, latching, etc.)
SEt 2	Set 2	Program set point 2
rSEt 2	Reset 2	Program reset point 2
FLSF	Fail-safe	Enter Fail-safe menu
FLS 1	Fail-safe1	Set relay 1 fail-safe operation
on	On	Enable fail-safe operation
oFF	Off	Disable fail-safe operation
FLS 2	Fail-safe2	Set relay 2 fail-safe operation
dLY	Delay	Enter Time Delay menu
dLY 1	Delay 1	Enter relay 1 time delay setup
On 1	On 1	Set relay 1 On time delay
OFF 1	Off 1	Set relay 1 Off time delay
dLY 2	Delay 2	Enter relay 2 time delay setup
On 2	On 2	Set relay 2 On time delay
OFF 2	Off 2	Set relay 2 Off time delay
brEH	Break	Set RTD/TC input break relay behavior
brH 1	Relay 1 Break	Set relay 1 input break relay behavior
OFF	Off	Set relay to non-alarm condition at break
On	On	Set relay to alarm condition at break
brH 2	Relay 2 Break	Set relay 2 input break relay behavior
Rout	Analog output	Enter the Analog output menu
ScRL	Scale	Enter the Scale menu
d IS 1	Display 1	Program display 1 value
out 1	Output 1	Program output 1 value (e.g. 4 mA)
d IS 2	Display 2	Program display 2 value
out 2	Output 2	Program output 2 value (e.g. 20 mA)
SEbr	Sensor break	Program TC or RTD sensor break value for analog out
PRSS	Password	Enter the Password menu
unLC	Unlocked	Program password to lock meter
LoCd	Locked	Enter password to unlock meter
9999 - 1999	Flashing display	Overrange condition Underrange condition
oPEr		Open TC or RTD sensor

Main Menu

The main menu consists of the most commonly used functions: *Setup* and *Password*.

- Press **Menu** button to enter Programming Mode then press **Up** arrow button to scroll main menu.

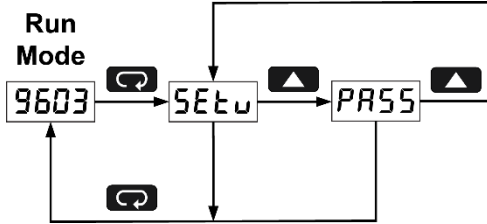

- Press **Menu**, at any time, to exit and return to Run Mode. Changes made to settings prior to pressing **Enter/Ack** are not saved.
- Changes to the settings are saved to memory only after pressing **Enter/Ack**.
- The display moves to the next menu every time a setting is accepted by pressing **Enter/Ack**.

Setting Numeric Values

The numeric values are set using the **Right** and **Up** arrow buttons. Press **Right** arrow to select next digit and **Up** arrow to increment digit value. The digit being changed is displayed brighter than the rest.

Press the **Enter/Ack** button, at any time, to accept a setting or **Menu** button to exit without saving changes.

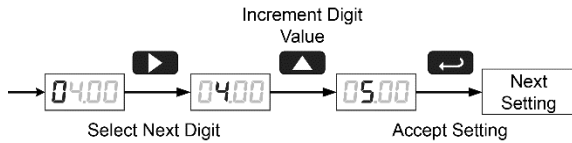

The decimal point is set using the **Up** arrow button in the *Setup-decimal point* menu.

Setting Up the Meter (SEtU)

The *Setup* menu is used to select:

1. Input signal the meter will accept
2. Decimal point position for process inputs
3. Units (°F or °C) for temperature inputs
4. Relay operation
5. 4-20 mA analog output setup

Press the **Enter/Ack** button to access any menu or press **Up** arrow button to scroll through choices. Press the **Menu** button to exit at any time.

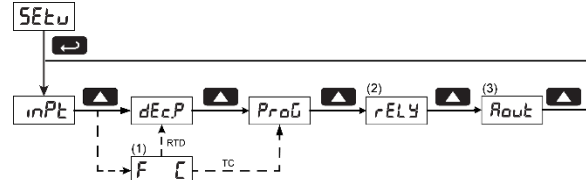

Notes:

1. Selecting RTD or TC mode from the Input menu will include the Fahrenheit/Celsius menu in the setup menu structure. RTD will allow the selection of a decimal point location after this menu and TC has a fixed decimal point location and will not allow the selection of a decimal point location.
2. Relay menu is always available even if relays option is not installed. Visual alarm indication is available through front panel LEDs and MeterView software.
3. Analog Output menu is available if selected in the Advanced Features menu. 4-20 mA output option board is installed and set up at the factory.

Setting the Input Signal (inPt)

Enter the *Input* menu to set up the meter to display current (4-20), voltage (0-10), thermocouple (tC), or RTD (rtd) inputs.

The voltage input is capable of accepting any signal from -10 to +10 VDC. Select voltage input to accept 0-5, 1-5, 0-10, or ±10 VDC signals.

The current input is capable of accepting any signal from -20 to 20 mA. Select current input to accept 0-20 or 4-20 mA signals.

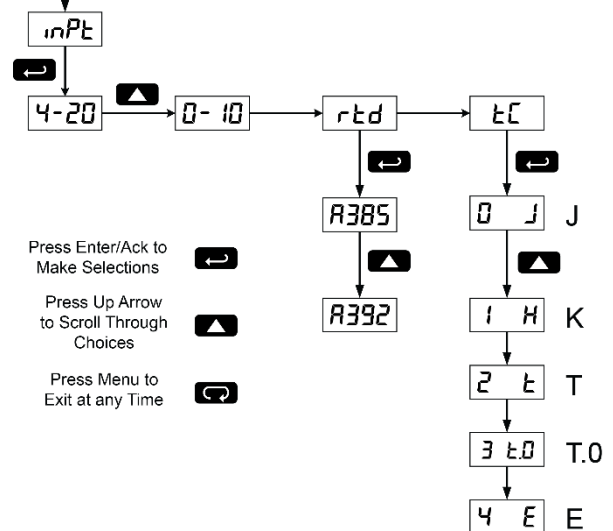

- Press Enter/Ack to Make Selections
- Press Up Arrow to Scroll Through Choices
- Press Menu to Exit at any Time

If RTD is selected, the display shows *R385* or *R392*. Select the coefficient to match the RTD sensor, either 0.00385 (*R385* European curve) or 0.00392 (*R392* American curve). The display then shows the decimal point menu, *dEcP*. Select the decimal point resolution as shown on page 40.

If TC is selected, scroll through the thermocouple types and select the type matching the TC sensor. The input signal must be connected to the appropriate input terminals and the RTD/TC selector switch must be set, see *Figure 13. Thermocouple Input* on page 32.

For thermocouple inputs, allow at least 30 minutes warm-up time for meter to reach specified accuracy.

Setting the Decimal Point (*dEcP*)

The decimal point for process inputs may be set with up to three decimal places or with no decimal point at all. The decimal point for RTD inputs may be set with 1 decimal place or none. The decimal point for thermocouple inputs is fixed per input selection. Pressing the **Up** arrow moves the decimal point one place to the right until no decimal point is displayed, it then moves to the leftmost position.

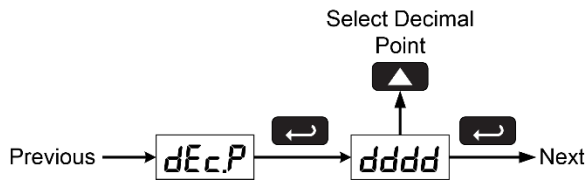

Setting the Temperature Scale (*F* \square)

Meters with a thermocouple or RTD input can be set to display temperature in degrees Fahrenheit or Celsius.

Press **Up** arrow to change selection.
Press **Enter/Ack** to accept.

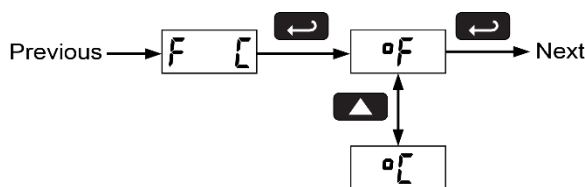

Programming the Meter (*Prog*)

The meter may either be scaled (*ScAL*) without applying an input or calibrated (*Cal*) by applying an input. The meter comes factory calibrated to NIST standards, so for initial setup, it is recommended to use the (*ScAL*) function. The Program menu contains the Scale (*ScAL*) and the Calibrate (*Cal*) menus. Process inputs may be scaled or calibrated to any display within the range of the meter.

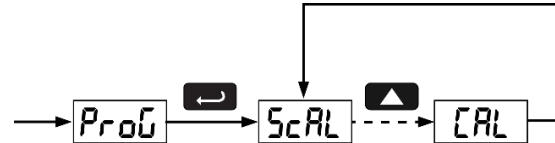

Scaling the Meter (*ScAL*)

The process inputs (4-20 mA and ± 10 VDC) can be scaled to display the process in engineering units. A signal source is not needed to scale the meter; simply program the inputs and corresponding display values.

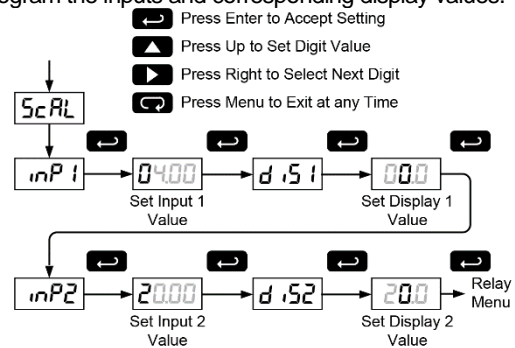

For instructions on how to program numeric values see *Setting Numeric Values*, page 39.

Note: The Scale menu is not available for temperature inputs.

Error Message (*Err*)

An error message indicates that the calibration or scaling process was not successful. After the error message is displayed, the meter reverts to input 1, allowing the appropriate input signals to be applied. The error message might be caused by any of the following conditions:

1. Input signal is not connected to the proper terminals or it is connected backwards.
2. Wrong signal selection in *Setup* menu.
3. Minimum input span requirements not maintained.
4. Input 1 signal inadvertently applied to calibrate input 2.

IMPORTANT

- **Reverse Scaling**
The meter can be scaled so that 4 mA represents the high end of the process value range being measured by the transmitter and 20 mA represents the low end of the process value range.

Minimum Input Span

The minimum input span is the minimum difference between input 1 and input 2 signals required to complete the calibration or scaling of the meter.

Input range	Input 1 & input 2 span
4-20 mA	0.40 mA
±10 VDC	0.20 VDC
TC	100°F (56°C)
RTD	50°F (28°C)

Calibrating the Meter (CAL)

The meter can be calibrated to display the process in engineering units by applying the appropriate input signals and following the calibration procedure. The use of a calibrated signal source is required to calibrate the meter.

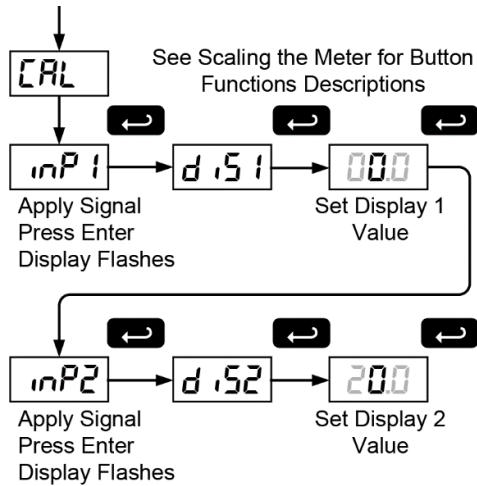

Recalibrating Temperature Inputs (CAL)

Remember, the meter is **calibrated** at the factory prior to shipment. Recalibration is recommended at least every twelve months. The *Calibration* (CAL) menu is used to **recalibrate** the thermocouple and RTD inputs.

Allow at least 30 minutes warm-up time before performing recalibration procedure to ensure specified accuracy.

Recommended Calibration Points

To recalibrate the meter, it is recommended to use the Fahrenheit scale; this will give a greater degree of accuracy to the calibration. The scale can be changed to the Celsius scale after calibration is completed. The meter will display temperature accurately in any scale. The following table shows the recommended low and high calibration points for all types.

Type of input	Input 1 (Low)	Input 2 (High)	Check (Middle)
Type J T/C	32°F	1182°F	600°F
Type K T/C	32°F	1893°F	960°F
Type T T/C	32°F	693°F	360°F
Type T T/C	32.0°F	693.0°F	360.0°F
Type E T/C	32°F	1652°F	840°F
100 Ω RTD (0.00385)	32°F 100Ω	1148°F 320.12Ω	590°F 215.61Ω
100 Ω RTD (0.00392)	32°F 100Ω	1127°F 320.89Ω	580°F 215.87Ω

Recalibration Procedure for Temperature Inputs

1. Connect signal to the meter using the appropriate wire (e.g. type J thermocouple wire to recalibrate type J input), see page 32.
2. Set up the meter to accept the selected input (e.g. type J T/C), see page 39.
3. Set up the meter to display temperature in degrees Fahrenheit, see page 40.
4. Apply signal corresponding to input 1 (32°F) and program display 1 to 32, see page 41.
5. Apply signal corresponding to input 2 (1182°F for type J) and program display 2 accordingly, see page 41.
6. After the meter accepts input 2, the display flashes the message [J] that indicates the meter is sensing the cold junction reference. This completes the recalibration procedure for the selected input.

Recalibrating Process Inputs (CAL)

The *Internal Calibration* (CAL) menu, located in the Advanced features menu, is used to recalibrate the current and voltage inputs. Recalibration is recommended at least every twelve months. Refer to *Internal Calibration* (CAL), page 52 for instructions.

Setting the Relay Operation (rELY)

This menu allows you to set up the operation of the relays:

1. Relay action (Rct)
 - a. Automatic reset only (non-latching)
 - b. Automatic + manual reset at any time (non-latching)
 - c. Latching (manual reset only)
 - d. Latching with Clear (manual reset only after alarm condition has cleared)
 - e. Pump alternation control (automatic reset only)
 - f. Off (relay and status LED disabled)
2. Set point
3. Reset point
4. Fail-safe operation
 - a. On (enabled)
 - b. Off (disabled)
5. Time delay
 - a. On delay (0-199 seconds)
 - b. Off delay (0-199 seconds)
6. Break Condition Behavior
 - a. Off (non-alarm condition)
 - b. On (alarm condition)

Refer to page 38 for a description of *Display Functions and Messages*

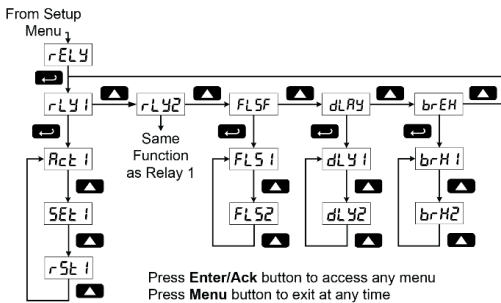

Acknowledging Relays

There are two ways to acknowledge relays programmed for manual reset:

1. Via ACK (F3) CapTouch through-glass button.



2. Remotely via terminal at the back of the meter by a connector switch across terminals 4 and C.

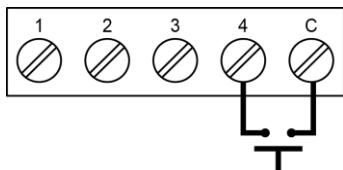

Setting the Relay Action

The relays' Action menu allows the user to set up the operation of the relays. The relays may be set up for any of the following modes of operation:

1. Automatic reset (non-latching)
2. Automatic + manual reset at any time (non-latching)
3. Latching (manual reset only, at any time)
4. Latching with Clear (manual reset only after alarm condition has cleared)
5. Pump alternation control (automatic reset only)
6. Off (relay and status LED disabled)

The following graphic shows relay 1 action setup; relay 2 is set up in a similar fashion.

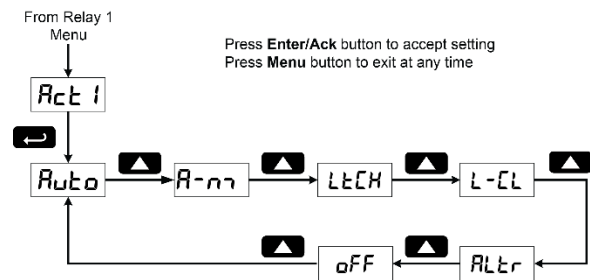

Programming Set and Reset Points

High alarm indication: program set point above reset point.

Low alarm indication: program set point below reset point.

The deadband is determined by the difference between set and reset points. Minimum deadband is one display count. If set and reset points are programmed the same, relay will reset one count below set point.

Quick Set Points

Press **Up** arrow and **Menu** at the same time to access set/reset points quickly.

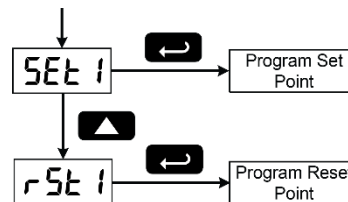

Setting Fail-Safe Operation

The fail-safe operation is set independently for each relay. Select **on** to enable or select **off** to disable fail-safe operation.

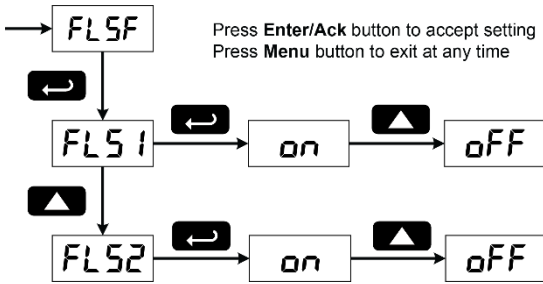

Programming Time Delay

The On and Off time delays may be programmed for each relay between 0 and 199 seconds. The relays will transfer only after the condition has been maintained for the corresponding time delay. The On time delay is associated with the set point. The Off time delay is associated with the reset point.

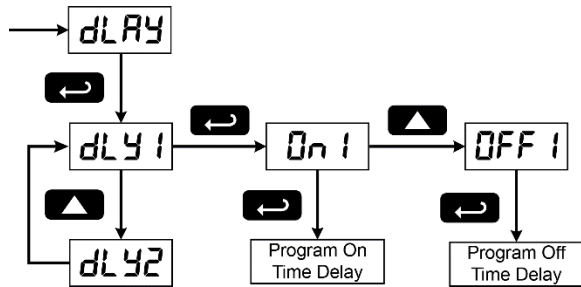

Setting Sensor Break Condition

The sensor break relay condition may be programmed for each relay as On (alarm) or Off (non-alarm). The relays will enter these states when a sensor break is detected for RTD or thermocouple inputs. These settings have no effect when current or voltage inputs are selected.

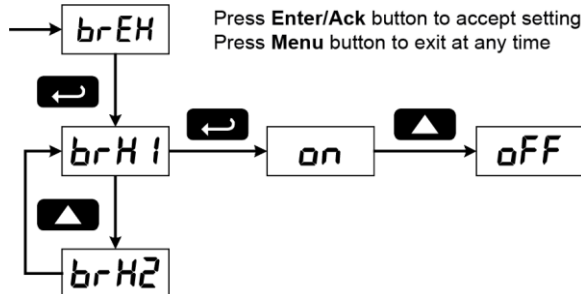

Sensor Break Operation

The following graphs illustrate the operation of how the meter reacts when a sensor break is detected.

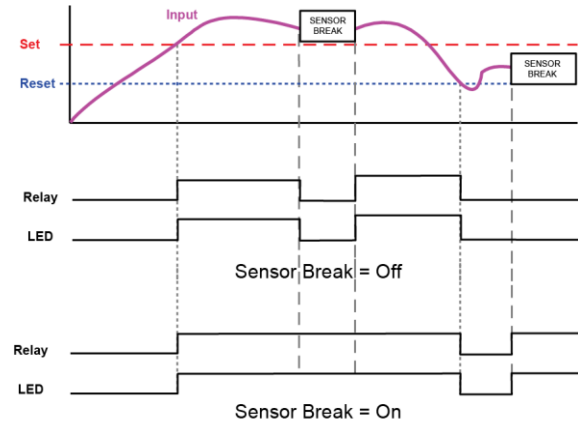

Relay and Alarm Operation

The following graphs illustrate the operation of the relays, status LEDs, and ACK button.

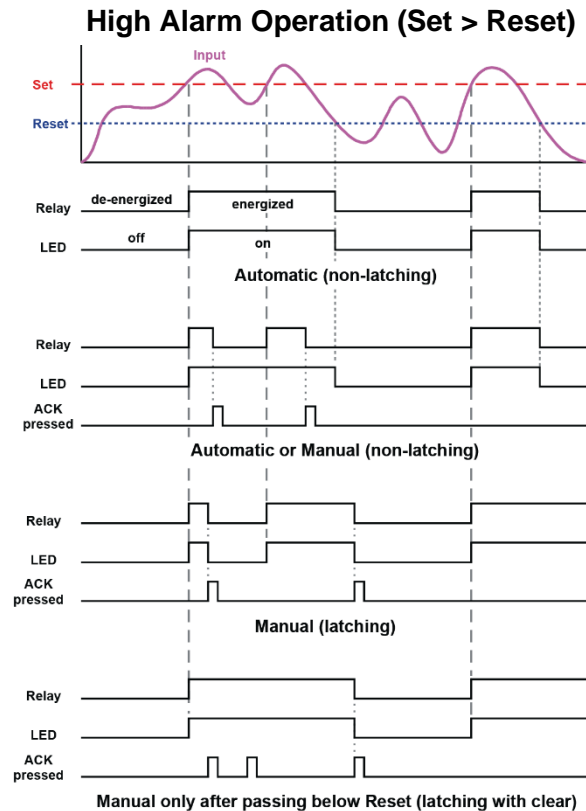

For Manual reset mode, ACK can be pressed anytime to turn "off" relay. For relay to turn back "on", signal must go below set point, and then go above it.

Low Alarm Operation (Set < Reset)

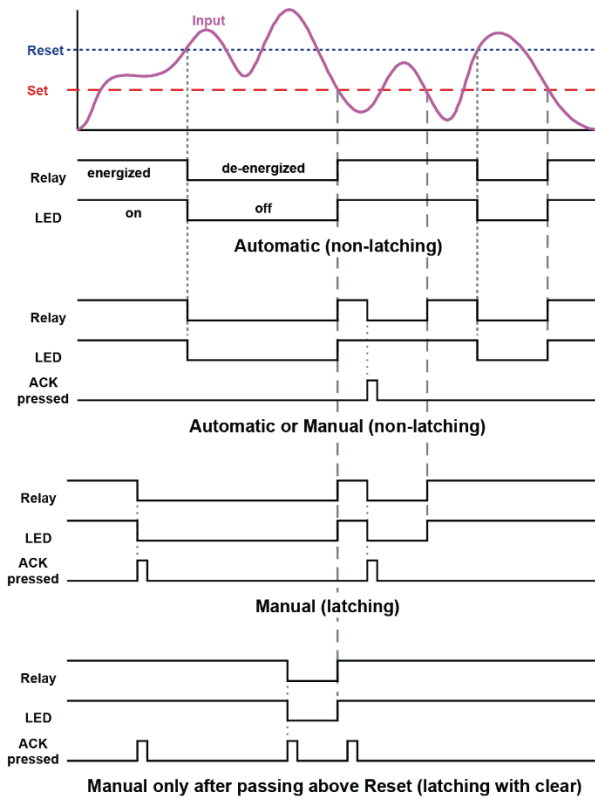

For Manual reset mode, ACK can be pressed anytime to turn "off" relay. For relay to turn back "on", signal must go above set point, and then go below it.

Time Delay Operation

The following graphs show the operation of the time delay function.

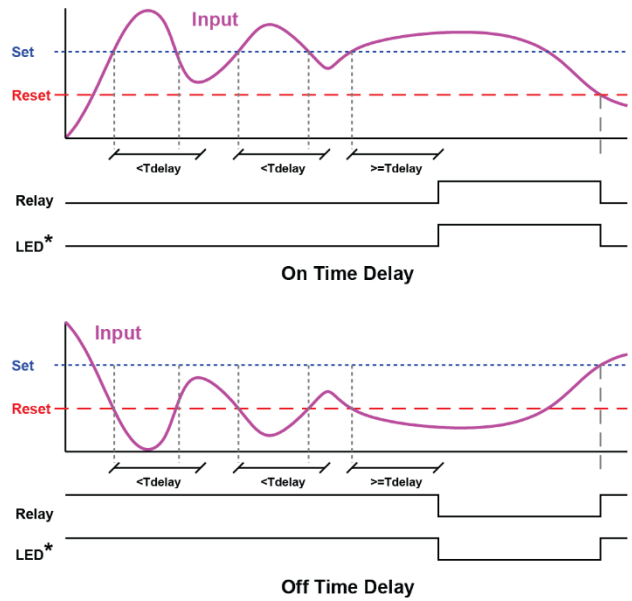

If the signal crosses the set point, the *On* time delay timer starts and the relay trips when the time delay has elapsed. If the signal drops below the set point (high alarm) before the time delay has elapsed, the *On* time delay timer resets and the relay does not change state. The same principle applies to the *Off* time delay.

* **Note:** The LED is not affected by Time Delay when "Automatic or Manual" reset mode is selected. Rather the LED follows the set and reset points.

High Alarm with Fail-Safe Operation (Set > Reset)

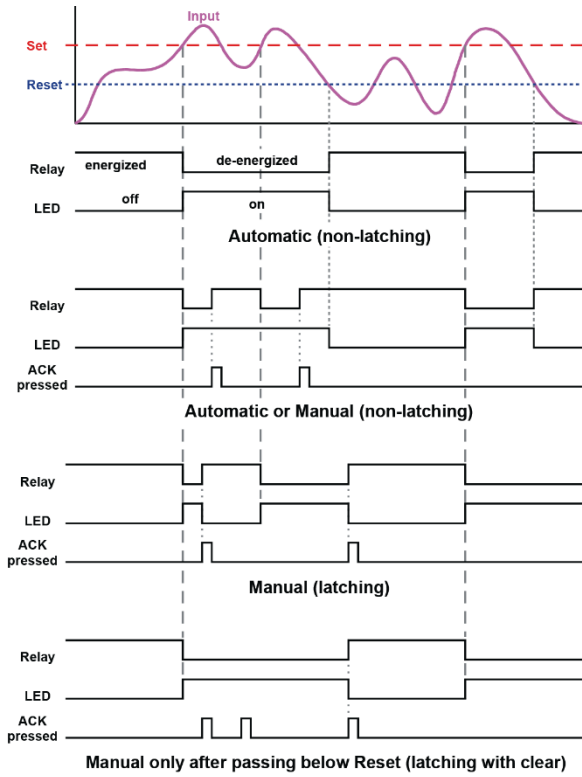

* **Note:** Relay coil is energized in non-alarm condition. In case of power failure, relay will go to alarm state.

Low Alarm with Fail-Safe Operation (Set < Reset)

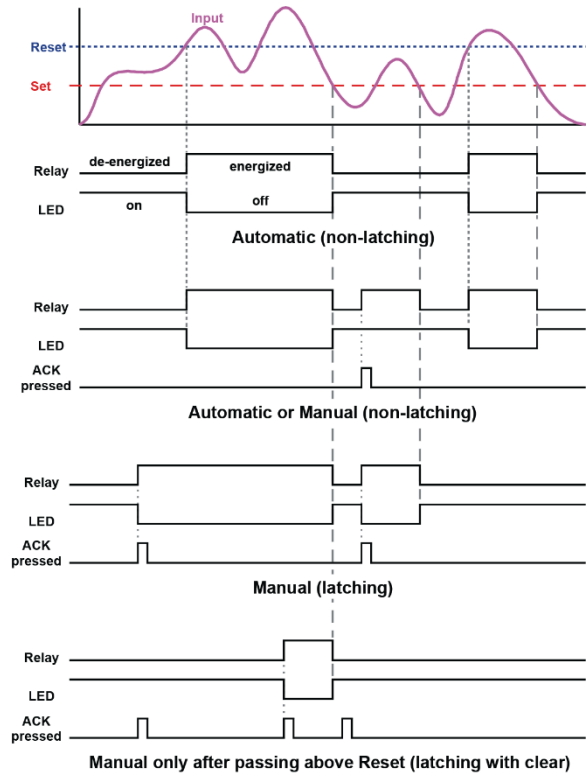

* **Note:** Relay coil is energized in non-alarm condition. In case of power failure, relay will go to alarm state.

Pump Controller with Dual-Pump Alternation

The PD8-765 can be used as a low-cost pump controller when combined with a continuous level transmitter. One of the most common pump control applications is shown below: controlling and alternating two pumps. The goal is to control the level between 1000 and 6000 gallons. The main pump turns on when the level reaches 6000 gallons and pumps down to 1000 gallons and then shuts the pump off. The next cycle, the backup pump turns on at 6000 gallons and shuts off at 1000 gallons. If at any time the active pump can't keep the level below 7000 gallons, the other pump would come on also.

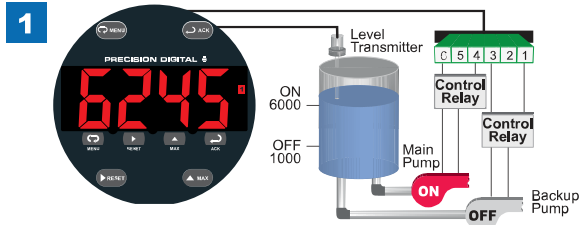

Relay #1 turns the main pump on at 6000 gallons and turns it off at 1000 gallons.

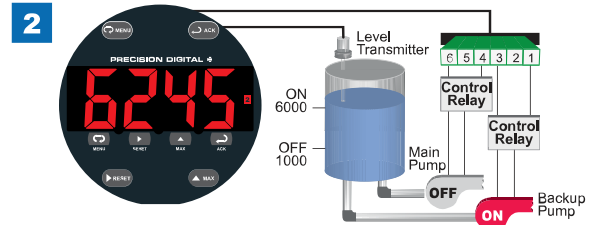

With the Pump Alternation feature activated, the next time the level reaches 6000 gallons, relay #2 starts the backup pump.

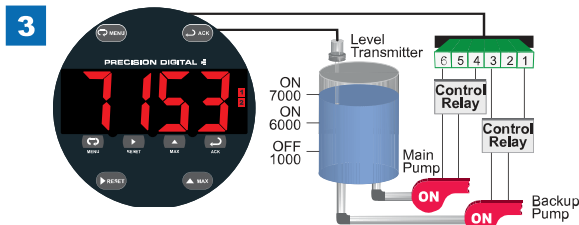

If the active pump is not able to keep up, and the level reaches 7000 gallons, the other relay will start the inactive pump as well.

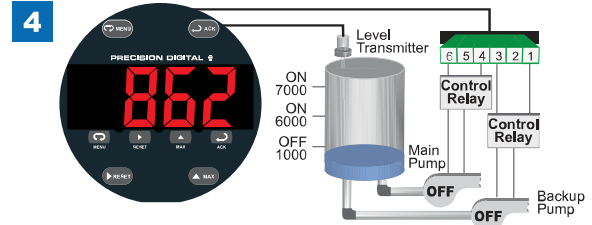

When the level falls below 1000 gallons, both pumps will turn off.

Pump Alternation Control Operation

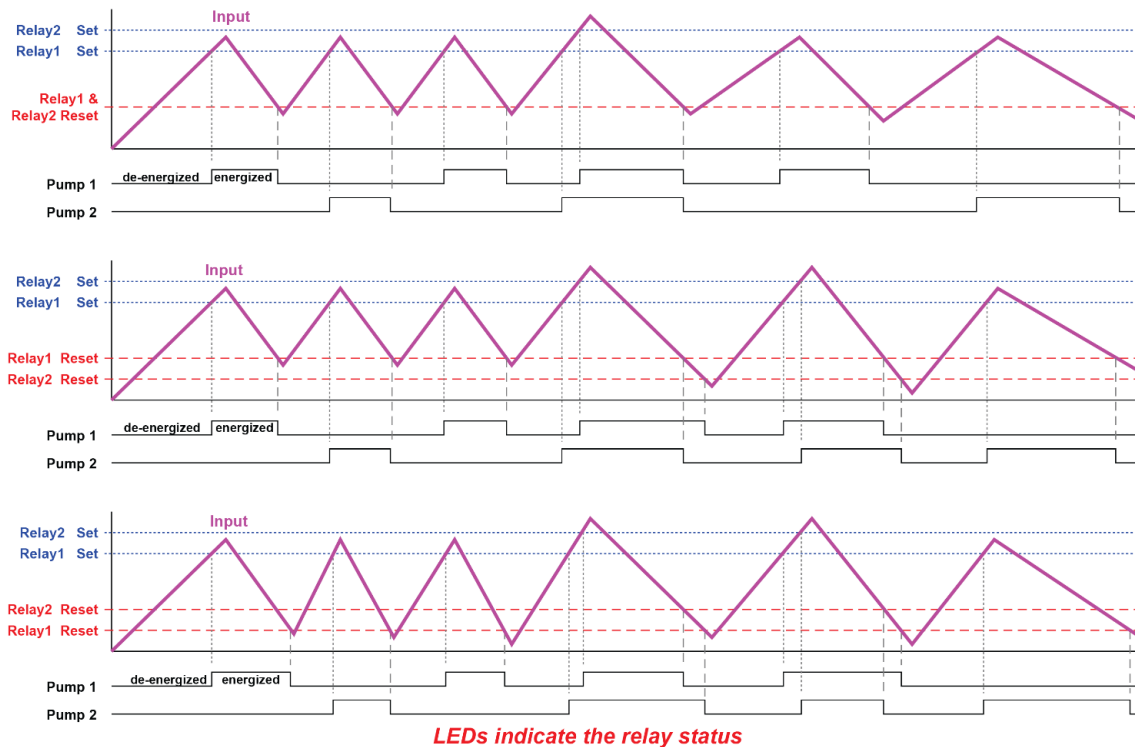

Scaling the 4-20 mA Analog Output (Rout)

The 4-20 mA analog output can be scaled to provide a 4-20 mA signal for any display range selected.

No equipment is needed to scale the analog output; simply program the display values to the corresponding mA output signal.

The *Analog Output* menu appears in the *Setup* menu only on meters that are equipped with a 4-20 mA output. This menu is enabled or disabled at the factory via the *Advanced Features* menu. For more information on the *Advanced Features Menu*, see page 48.

The *Analog Output* menu is used to program:

1. 4-20 mA output based on display values
2. Sensor break value in mA

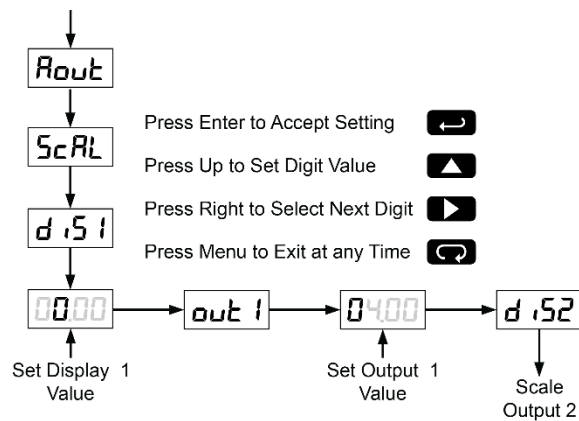

For instructions on how to program numeric values see *Setting Numeric Values*, page 39.

Program the Sensor Break Output Value (SEbr)

The sensor break value corresponds to the output signal generated when the meter detects a sensor break for thermocouple and RTD inputs.

For example, if there is an open thermocouple, the meter displays the message "oPEn" and the analog output goes to the programmed sensor break value (e.g. 3.00 mA).

The sensor break value can be programmed from 0.00 to 23.99.

The typical output signal range is 1.00 to 23.00 mA (e.g. If sensor break value is programmed to 0.00, the actual output will not be greater than 1.00 mA).

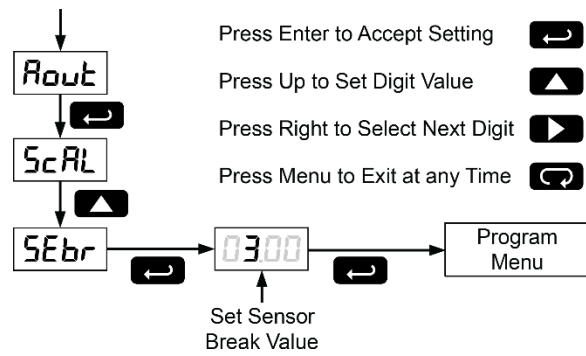

Analog Output when Display is Out of Range

The analog output reflects the display out of range conditions as follows:

Input Condition	Display	Analog Output
Underrange	Flashing -1999	3.00 mA
Overrange	Flashing 9999	21.00 mA
Open TC or RTD	Flashing oPEn	Sensor break value

Setting Up the Password (PASS)

The *Password* menu is used to program a four-digit password to prevent unauthorized changes to the programmed parameter settings.

Locking the Meter

Enter the *Password* menu and program a four-digit password.

For instructions on how to program numeric values see *Setting Numeric Values*, page 39.

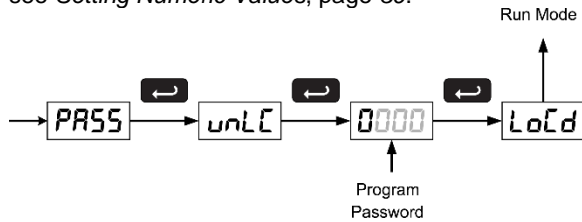

Record the password for future reference. If appropriate, it may be recorded in the space provided.

Model:	
Serial Number:	
Password:	_____

Unlocking the Meter

If the meter is password protected, the correct password must be entered in order to make changes to the parameter settings.

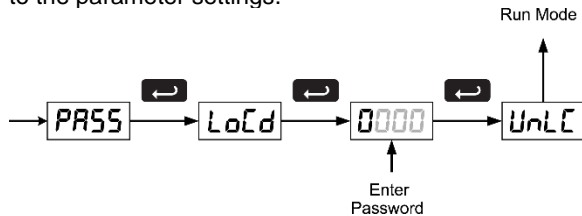

Entering the correct four-digit number sets the password to 0000, disabling the protection. Changes to the programmed parameter settings are allowed only with the password set to 0000. If the password entered is incorrect, the meter displays *LoCd* (Locked) for about two seconds, then it returns to *Run Mode*. To try again, press **Enter/Ack** while the *Locked* message is displayed.

Forgot the Password?

The password may be disabled by the following procedure:

- Note display reading prior to pressing the Menu button. Ignore decimal point and sign.
- Access the *Password* menu, add 2 to the noted reading and enter that number as the password (e.g. display reading = -1.23, password = 0125)

Advanced Features Menu

To simplify the setup process, functions not needed for most applications are located in the *Advanced Features* menu.

Press the **Right** arrow and **Menu** button simultaneously or hold the Menu button for approximately 3 seconds to access the *Advanced Features Menu* of the meter.

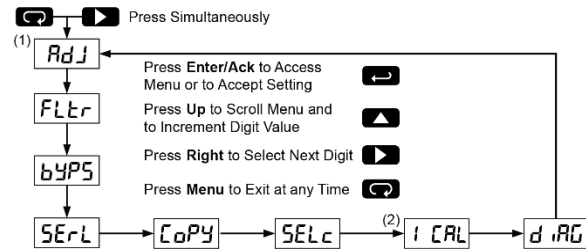

- Available for temperature inputs only
- Available for process inputs only

Advanced Features Menu & Display Messages

Display Functions and Messages

Display	Parameter	Action/Setting
RdJ	Adjust	Set offset adjustment for temperature, not available for process inputs
FLtr	Filter	Set noise filter value
bYP5	Bypass	Set filter bypass value
SErL	Serial	Set serial communication parameters
Prot	Protocol	Enter the Protocol menu
PdC	PDC	Select PDC protocol
mb5	Modbus®	Select Modbus® protocol
Raddr	Address	Set meter address
bRud	Baud rate	Select baud rate
trdE	Transmit delay	Set transmit delay for serial communication
Prty	Parity	Select none, even, or odd (Modbus® only)
tbYt	Byte-to-byte	Program byte-to-byte timeout (silent time – Modbus® only)
CoPY	Copy	Enter copy function
SEnd	Send	Send meter settings to another meter
donE	Done	Copy function completed
SElc	Select	Enter the Select menu (function, cutoff, out)
Func	Function	Select linear or square root function
L inr	Linear	Set meter for linear function
SqrE	Square root	Set meter for square root extraction
cutF	Cutoff	Set low-flow cutoff

Display Functions and Messages		
Display	Parameter	Action/Setting
OUT	Output	Set meter for either relay or analog output (factory set only; only included in certain models)
ROUT	Analog output	Set meter for analog output option
RELY	Relay	Set meter for relay option
ROUT	Analog output	Enable or disable analog output (factory set only; only included in certain models)
YES	Yes	Enable analog output
NO	No	Disable analog output
INTY	Intensity	Select display intensity
ICAL	Initial calibration	Enter initial calibration for process inputs
CURR	Current	Calibrating current input
I LO	I low	Calibrate low current input
I HI	I high	Calibrate high current input
VOLT	Volt	Calibrating voltage input
V LO	V low	Calibrate low voltage input
V HI	V high	Calibrate high voltage input
diAG	Diagnostics	Display parameter settings
LED	LED	Test display
CJC	CJC	Display cold junction compensation voltage
CFG	CFG	Display meter configuration
PTS	Points	Display calibration points for process inputs
RELY	Relays	Display relay settings
ROUT	Analog output	Display analog output settings
GAIN	Gain/offset	Display gain and offset for process inputs
SERL	Serial	Display serial communication settings
INFO	Information	Display software version and S/N information

Offset Adjustment (Adj)

This parameter allows the user to select an offset adjustment to the temperature being displayed. Offset adjustment values can be either positive or negative and can be any number within $\pm 19.9^\circ$. The offset adjustment value is programmed through the *Adjust* menu.

The offset adjustment feature can be useful to compensate for errors due to thermocouple junctions or excessive lead wire resistance in RTDs.

The offset adjustment value is automatically reset to zero whenever the type of temperature sensor is changed (*i.e.*, Thermocouple type or RTD curve). Celsius/Fahrenheit conversion of the offset adjustment value is automatic, see note 2 below for important limitations.

Notes:

1. Offset adjustment is available only when TC or RTD input is selected.
2. If adjustment value is greater than 11°C and the temperature scale is changed to Fahrenheit, the maximum applied adjustment will be 19.9°F .

Noise Filter (FLtr)

Most applications do not require changing this parameter. It is intended to help attain a steady display with an unsteady (noisy) input signal.

The field selectable noise filter averages any minor or quick changes in the input signal and displays the reading with greater stability.

Increasing the filter value will help stabilize the display, however this will reduce the display response to changes on the input signal.

The filter level may be set anywhere from 2 to 199. Setting filter value to zero disables filter function, and bypass setting becomes irrelevant.

Noise Filter Bypass (bYP5)

The meter can be programmed to filter small input changes, but allow larger input changes to be displayed immediately, by setting the bypass value accordingly.

If the input signal goes beyond the bypass value, it will be displayed immediately with no averaging done on it.

The noise filter bypass value may be set anywhere from 0.2 to 99.9. It corresponds to percentage of full scale for process inputs and to degrees Fahrenheit for temperature inputs.

Increasing the bypass value may slow down the display response to changes on the input signal.

Serial Communications (SErL)

The meter is equipped with serial communications capability as a standard feature using Modbus RTU Serial Communication Protocol. The meter may be connected to a PC for initial configuration via the on-board USB connection. For ongoing digital communications with a computer or other data terminal equipment, use the RS-485 connection with the appropriate serial converter; see *Ordering Information* on page 7 for details.

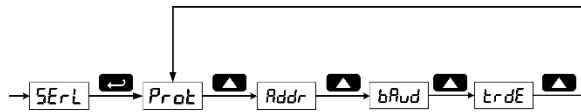

When using more than one meter in an RS-485 multi-drop mode, each meter must be provided with its own unique address. The address may be programmed from 00 to 99 for PDC protocol and from 1 to 247 for Modbus protocol. The transmit delay may be set between 0 and 199 ms (see Serial Communication Adapter manual for more details). The PD8-765 can also be connected directly to another PD8-765 through a cable assembly (PDA7420). This allows the user to copy all the settings from one meter to another, using the *Copy* function.

Protocol Selection Menu (PrOt)

The Protocol selection menu is used to select either the PDC or the Modbus protocol. PDC protocol should be selected to run MeterView software.

Select Menu (SELc)

The *Select* menu is used to select linear or square root function, display intensity, and low-flow cutoff. Selection for relay or analog output is a factory setting depending on the option installed.

- Output options are installed and set up at the factory.
- Changing the output selection will cause erroneous operation.

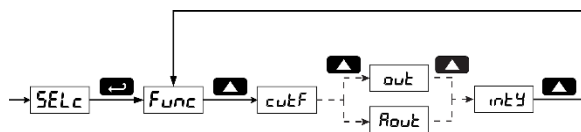

Note: Depending on meter model, the Select menu will display either out or Aout. In either case, the output selection menu is for factory use only. Do not attempt to change output selection.

Linear or Square Root Function (L inr or SqrE)

Meters are set up at the factory for linear function. The linear function provides a display that is linear with respect to the input signal. The square root function is used to linearize the signal from a differential pressure transmitter and display flow rate in engineering units.

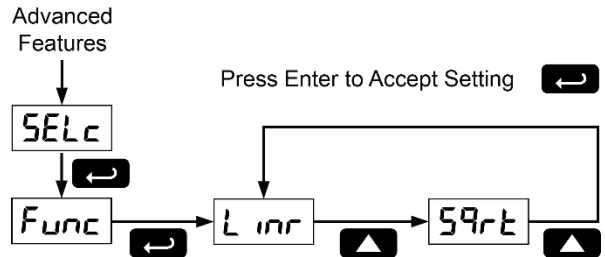

Low-Flow Cutoff (cutF)

The low-flow cutoff feature allows the meter to be programmed so that the often-unsteady output from a differential pressure transmitter, at low flow rates, always displays zero on the meter. The cutoff value may be programmed from 0 to 9999. Below the cutoff value, the meter will display zero. Programming the cutoff value to zero disables the cutoff.

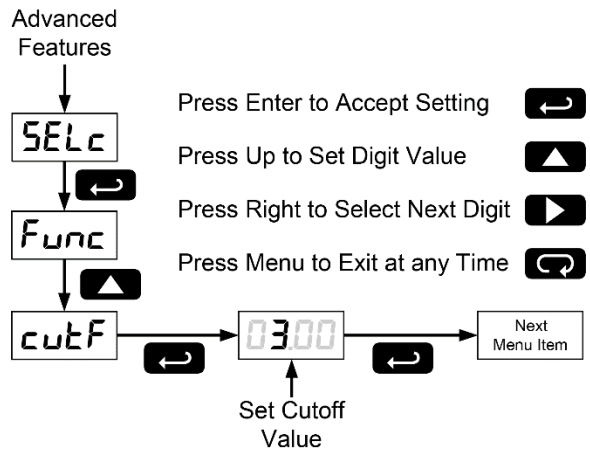

Display Intensity (intensity)

The Display Intensity function allows the selection of eight levels of intensity for various lighting conditions.

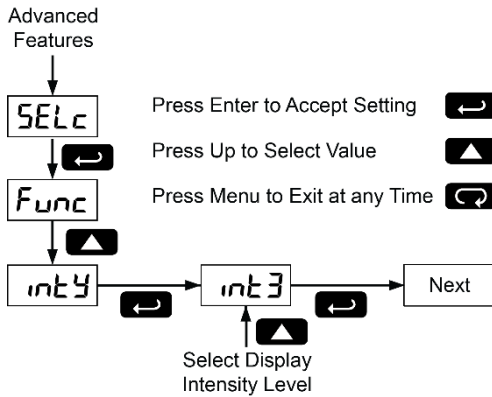

Meter Copy Function (COPY)

The Copy function is used to copy (or clone) all the settings from one meter to other meters requiring exactly the same setup and programming (i.e. type of input, scaling, decimal point, filter, bypass, etc.).

Copy Function Requirements

To successfully copy settings from one meter to another, both meters must have:

1. Same software version
2. Same baud rate setting
3. PDC protocol selected

See *Determining Software Version*, page 55 for instructions.

Meter Cloning Instructions

CAUTION

- Do not connect the two meters to the same 4-20 mA loop while cloning. Internal calibration may be affected.
- Connect the two meters using cable assembly PDA7420 or equivalent (e.g. Digi-Key P/N H1663-07-ND). Cable should not exceed 7' (2.1 m).

1. Power up both meters. Leave Clone meter in Run Mode.
2. Enter the *Advanced Features Menu* of the Master meter, see *Advanced Features Menu*, page 48.
3. Scroll to *Copy* function using **Up** arrow button then press **Enter/Ack**.
4. The meter displays the message `SEnd`. Press **Enter/Ack**, the display flashes while sending data. The message `done` is displayed when copying is completed.

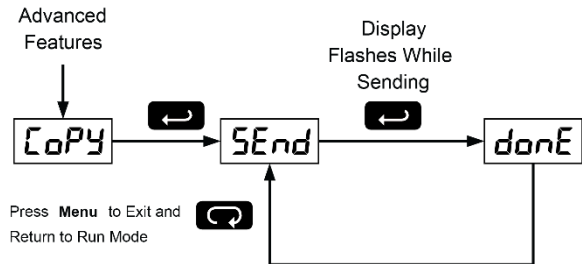

5. The Clone meter displays the memory address being programmed then the message `done` when copying is completed. The meter initializes and returns to Run Mode using the same settings as the Master.
6. If meter to be cloned does not respond to the data being sent, refer to **Copy Function Requirements** above.

Internal Calibration (I CAL)

- There is **no need to recalibrate** the meter when first received from the factory.
- The meter is **factory calibrated** prior to shipment, for all input types, in milliamps, volts, and degrees respectively. The calibration equipment is certified to NIST standards.

The internal calibration allows the user to scale the meter without applying a signal. This menu is not available if the meter is set up for TC or RTD inputs.

The use of calibrated signal sources is necessary to perform the internal calibration of the meter. Check calibration of the meter at least every 12 months. Each input type must be recalibrated separately, if meter will be used with all input types.

- Notes:
- If meter is in operation and it is intended to accept only one input type (e.g. 4-20 mA), recalibration of other inputs is not necessary.
 - Allow the meter to warm up for at least 30 minutes before performing the internal calibration procedure.

The *Internal calibration* menu is part of the *Advanced Features Menu*.

1. Press the **Up** arrow button to scroll to the *Internal calibration* menu and press **Enter/Ack**.
2. The meter displays either current (I CURR) or voltage (u VLT), according to the meter input setup. Press **Enter/Ack** to start the calibration process.

Example for current input internal calibration:

3. The meter displays *Low* input current (I Lo). Apply the low input signal and press **Enter/Ack**. The display flashes for a moment while meter is accepting the low input.
4. After the display stops flashing, a number is displayed with the leftmost digit brighter than the rest. The bright digit is the active digit that can be changed by pressing the **Up** arrow button. Press the **Right** arrow button to move to the next digit.
5. Set the display value to correspond to the input signal being calibrated.
6. The display moves to the high input calibration (I Hi). Apply the high input signal and press **Enter/Ack**.
7. Set the display for the high input calibration in the same way as it was set for the low input calibration.

For instructions on how to program numeric values see *Setting Numeric Values*, page 39.

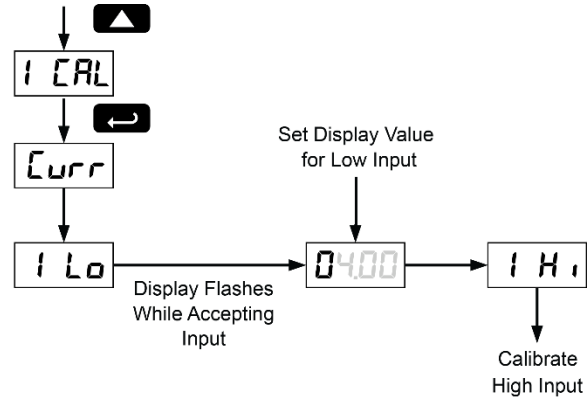

The graphic above shows the calibration of the current input. The voltage input is calibrated in a similar way.

Tips:

- Low and high input signals can be any valid values within the range of the meter.
- Observe minimum input span requirements between input 1 and input 2.
- Low input must be less than high input signal.

Error Message (Err)

An error message indicates that the calibration or scaling process was not successful. After the error message is displayed, the meter reverts to input 1, allowing the appropriate input signals to be applied.

The error message might be caused by any of the following conditions:

1. Input signal is not connected to the proper terminals, or it is connected backwards.
2. Wrong signal selection in *Setup* menu.
3. Minimum input span requirements not maintained.

Minimum Input Span

The minimum input span is the minimum difference between input 1 and input 2 signals required to complete the calibration or scaling of the meter.

Input range	Input 1 & input 2 span
4-20 mA	0.40 mA
±10 VDC	0.20 VDC





Meter Operation

When installed, the primary way to operate the meter is with the CapTouch through-glass buttons that allow the user to perform various operations without removing the cover and exposing the electronics to the hazardous environment. The user can also operate the meter by connecting a suitable control station or switch to one of the digital inputs that can be used to perform various operations on the meter based on the Programmable Function Keys. Finally, certain operations can be performed on the meter with MeterView Pro software or through Modbus commands.

The two default operations that can be performed with the meter's CapTouch buttons are:

1. Display the maximum and minimum readings
2. Acknowledge the relays

Buttons Operation

Button Symbol	Description
	Press to enter or exit Programming Mode, view settings, or exit Max/Min readings Hold to enter <i>Advanced Features Menu</i>
	Press to reset Max/Min readings
	Press to display Max/Min readings alternately
	Press to display Max/Min reading indefinitely while displaying Max/Min Press ACK to acknowledge relays



















For *Interactive Virtual Meter Demo* visit predig.com/tvm

Trident Virtual Meter

Virtual Meter Instructions

Programming 4-20 mA input

These instructions will show you how to program the Trident Virtual Meter to accept a 4-20 mA Input and display a value between 0 and 100.

1. Click  to enter *Programming Mode*, then click  to access the *SEtUp* (Setup) menu and again to access the *inPUt* (input) menu.
2. Select *4-20* (4-20 mA) and click  to confirm input selection. This should be the default option, but if it is not, click  to scroll through the choices.
3. Click  to access the *dECiM* (Decimal Point) menu. Click  until *ddd* (one decimal place) is displayed, then click  to confirm decimal point location.
4. Click  to access the *PrOG* (Program) menu and again to access the *ScALe* (Scale) menu.
5. Click  to access *inP1* (input 1). This is the input which represents 0% of the process variable. The default value of *4000* (4.00 mA) should be sufficient for most applications. Click  to accept this input value.
6. Click  to access *d1* (Display 1). This is the value that will be displayed on the meter when the current input is at 4 mA. Click  until the *Y* digit is brighter than the others (meaning it is selected) and then click  to increment the digit until it displays *0000*. Click  to accept the display value of *0000*.
7. Repeat steps 5 and 6 for *inP2* (input 2) and *d152* (Display 2). Accept the default input value of *20000* for input 2 and change the display 2 value to *1000* using the  and  buttons.
8. Click  to exit *Programming Mode* and return to *Run Mode*. Slide the input slider to the right of the meter to the left and right. Notice that when the input slider is all the way to the left, the meter now displays *000* and when the slider is all the way to the right, the meter displays *1000*.

Relay 1



Relay 2



20 mA

4 mA



Press the Menu button to toggle between Run and Program modes.

Reset Meter to Defaults

Advanced Features Menu

Share





Disclaimer: The Virtual Meter is not identical to its real counterpart. It cannot demonstrate all of the functionality, nor does it exactly resemble the physical meter.

Please note: The Virtual Meter closely approximates the functionality of the actual product. Both the real and virtual meters have additional functionality beyond that explained in the step-by-step instructions.

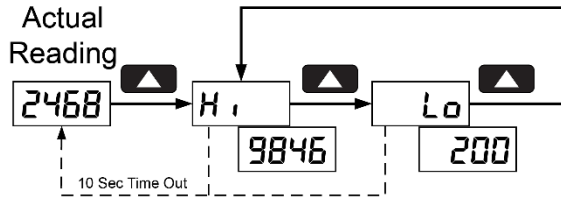
Maximum/Minimum Readings

The main function of the front panel buttons during operation is to display the maximum and minimum readings reached by the process or temperature inputs.



-  Press **Up** to Display and to Toggle Between Max/Min
-  Press **Enter** to Hold Max/Min
-  Press **Right** to Reset Max/Min
-  Press **Menu** to Exit Max/Min

1. Press **Up** arrow/**Max** button to display maximum reading since the last reset/power-up.
2. Press **Up** arrow/**Max** again to display the minimum reading since the last reset/power-up.
3. Press **Enter/Ack** to hold Max/Min display reading, the meter will continue to track new Max/Min readings.
4. If **Enter/Ack** is not pressed, the Max/Min display reading will time out after ten seconds and the meter will return to display the actual reading.
5. Press **Right** arrow/**Reset** button to reset Max/Min while reading is being displayed. Max/Min display readings are reset to actual reading.

Remote Operation of Meter Buttons

The PD8-765 is equipped with four external button contacts that can be used to remotely operate the PD8-765's front panel buttons. For instance, these button contacts can be used to program the meter and to remotely acknowledge/reset the relays:

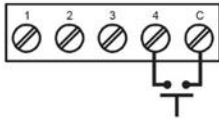

Terminal	Programming	Operation
1	Menu	
2	Right Arrow	Reset Max/Min
3	Up Arrow	Display Max/Min
4	Enter	Acknowledge Relays

Troubleshooting

For an *Interactive Virtual Meter Demo* visit predig.com/tvm

Due to the many features and functions of the meter, it's possible that the setup of the meter does not agree with what an operator expects to see. If the meter is not working as expected, refer to the *Diagnostics* menu and consult the recommendations described below.

It may also be helpful to program the meter using MeterView software. A [free USB adapter](#) can be sent to you if you register your meter.

Diagnostics Menu (d iRt)

The *Diagnostics* menu is located in the *Advanced Features Menu*, to access *Diagnostics* menu see *Advanced Features Menu*, page 48.

It provides an easy way to view the programmed parameter settings for troubleshooting purposes. Press the **Enter/Ack** button to view the settings and the **Menu** button to exit at any time.

For a description of the diagnostics messages see *Advanced Features Menu & Display Messages*, page 48.

Determining Software Version

To determine the software version of a meter:

1. Go to the *Diagnostics* menu (d iRt) and press **Enter/Ack** button.
2. Press **Up** arrow/**Max** button and scroll to *Information* menu (i n F a).
3. Press **Enter/Ack** to access the software number (S F t), version (V E r). Write down the information as it is displayed. Continue pressing **Enter/Ack** until all the information is displayed.

Reset Meter to Factory Defaults

When the parameters have been changed in a way that is difficult to determine what's happening, it might be better to start the setup process from the factory defaults.

Instructions to load factory defaults:

1. Enter the *Advanced Features Menu*. See *Advanced Features Menu*, page 48.
 2. Press **Up** arrow to go to *Diagnostics* menu
 3. Press and hold **Right** arrow/Reset for five seconds, press **Enter/Ack** when display flashes rESEt.
- Note:** If **Enter/Ack** is not pressed within three seconds, display returns to *Diagnostics* menu.
4. The meter goes through an initialization sequence (same as on power-up) and loads the factory default settings.

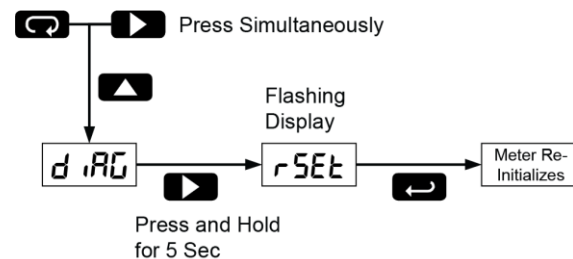

Factory Defaults & User Settings

The following table shows the factory setting for most of the programmable parameters on the meter. Next to the factory setting, the user may record the new setting for the particular application. MeterView software allows the saving of all meter parameters to a file for restoring meter settings, reporting, and copying settings to other meters.

Model: _____ S/N: _____
 Date: _____

Parameter	Display	Default Setting	User Setting
Input type	inPt	4-20 mA	
Decimal point	dddd	2 places	
Programming	PrO		
Input 1	inP1	4.00 mA	
Display 1	d151	4.00	
Input 2	inP2	20.00 mA	
Display 2	d152	20.00	
Relay 1	rLY1		
Action 1	Rct1	Automatic	
Set 1	SEt1	7.00	
Reset 1	r5t1	6.00	
Relay 2	rLY2		
Action 2	Rct2	Automatic	
Set 2	SEt2	10.00	
Reset 2	r5t2	9.00	
Fail-safe	FL5F		
Fail-safe 1	FL51	Off	
Fail-safe 2	FL52	Off	
Time delay	dLR		
On delay 1	On1	0 sec	
Off delay 1	OFF1	0 sec	
On delay 2	On2	0 sec	

Parameter	Display	Default Setting	User Setting
Off delay 2	OFF2	0 sec	
Break 1	brH1	Off	
Break 2	brH2	Off	
Password	PR55	0000 (unlocked)	
Advanced Features	N/A		
Adjust	Adj	0.0° (temp only)	
Filter	FLtR	10	
Bypass	bYP5	0.2	
Serial settings	SErL		
Protocol	PdC	PDC protocol	
Address	Rddr	00	
Baud rate	bRud	2400	
Trans delay	trdE	10 ms	
Function	Func	Linear	
Cutoff value	CutF	0.00 (disabled)	
Output option	out/Rout	Factory set only	
Display intensity	intY	Level 8	
Modbus® defaults	N/A		
Address	Rddr	247	
Parity	PrtY	Even	
Byte-to-byte timeout*	tBYt	0.01 sec	

* **Note:** The byte-to-byte timeout setting might be updated automatically depending on the baud rate selected and the previous timeout setting. The minimum timeout allowed is saved to memory if a lower value is entered (e.g. If user enters 0.00 with a baud rate of 300, 0.06 is saved)

Troubleshooting Tips

This meter is a highly sophisticated instrument with an extensive list of features and capabilities. If the front panel buttons are used to program the meter, it may be a difficult task to keep everything straight. That is why we strongly recommend the use of the MeterView software for all programming activities. A [free USB adapter](#) is available for programming with MeterView software if you register your meter.

Symptom	Check/Action
No display at all	Check power at power connector
Not able to change setup or programming, LoFd is displayed	Meter is locked, enter correct four-digit password to unlock
Meter does not respond to input change	If a Low-Flow Cutoff Value has been programmed, the meter will display zero below that point, regardless of the input – which can appear like the meter is not responding to an input change. Check to make sure the problem is not being caused by an undesired low-flow cutoff value.
Meter displays error message during calibration (Err)	Check: <ol style="list-style-type: none"> 1. Signal connections 2. Input selected in <i>Setup</i> menu 3. Minimum input span requirements
Meter displays <ul style="list-style-type: none"> • oPEr • 9999 • - 1999 • Displays negative number, not responding to RTD. 	Check: <ol style="list-style-type: none"> 1. Input selected in <i>Setup</i> menu 2. TC/RTD Switch position 3. Corresponding signal at Signal connector
Display alternates between <ol style="list-style-type: none"> 1. H i and a number 2. Lo and a number 	Press Menu to exit Max/Min display readings.
Display response is too slow	Check filter and bypass values
Inaccurate temperature reading	Check: <ol style="list-style-type: none"> 1. Temperature units (°F or °C) 2. TC type or RTD curve selected 3. Offset adjustment 4. TC wire used 5. Calibration
If the display locks up or the meter does not respond at all	Cycle the power to restart the microprocessor.
Relay operation is reversed	Check: <ol style="list-style-type: none"> 1. Fail-safe in <i>Setup</i> menu 2. Wiring of relay contacts
Relay and status LED do not respond to signal	Check: <ol style="list-style-type: none"> 1. Relay action in <i>Setup</i> menu 2. Set and reset points
Meter not communicating with MeterView or other programs	Check: <ol style="list-style-type: none"> 1. Serial adapter and cable 2. Serial protocol selected 3. Meter address and baud rate 4. MeterView address and baud rate
CapTouch buttons do not respond	<ol style="list-style-type: none"> 1. Check if slide switch on connector board is in DISABLE position, switch to ENABLE. 2. Be sure to hold the initial CapTouch button for 5 seconds to wake it up.
Serial Communications Power LED Indicator is off	Check: <ol style="list-style-type: none"> 1. Modular cable connection 2. Power to the device
If only the TX (or DATA IN) data status LED is flashing when serial communications attempted	Check <ol style="list-style-type: none"> 1. Serial cable 2. Protocol selected on device 3. Instrument address & baud rate 4. Program address & baud rate

Troubleshooting Tips

Symptom	Check/Action
If both data status LEDs (TX and RX) are off when trying to communicate	Remove all unnecessary cables and instruments from the bus. Try getting the system to work with only one device (to ease troubleshooting) and then expand the system one device at a time.
Communications slow	Increase the baud rate
Random communication errors	<ol style="list-style-type: none">1. Increase the TX delay time2. Decrease the baud rate
Other symptoms not described above	Call Technical Support for assistance.

Note: Certain sequences of events can cause unexpected results. To solve these issues, it is best to start fresh from factory defaults and use the manual as a step by step programming guide, rather than a random approach to programming. To reset the meter to factory defaults, see *Reset Meter to Factory Defaults* on page 55. In addition, for best results, we recommend using the free MeterView software for all programming needs.

Quick Interface Reference Guide

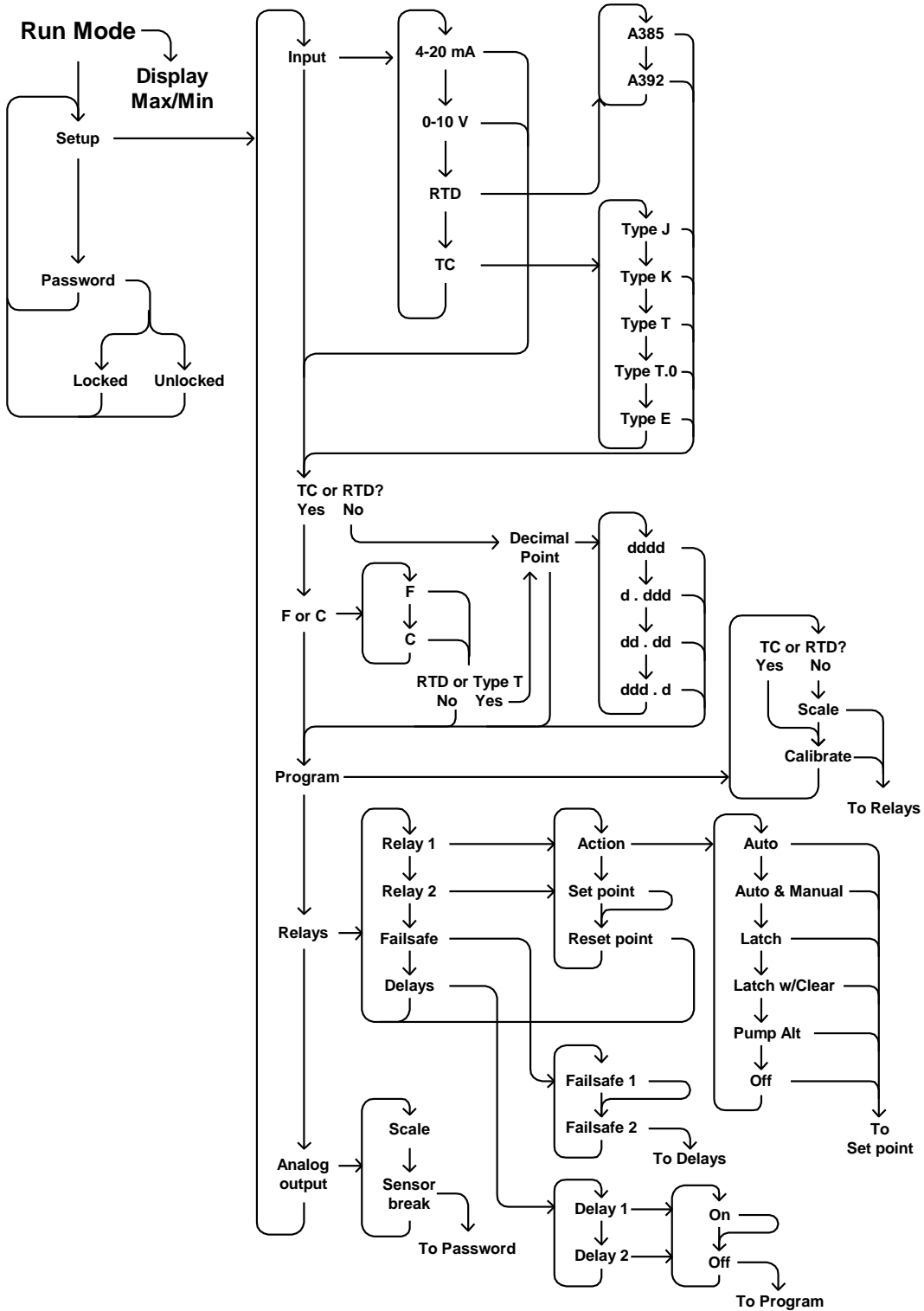

<u>Pushbutton</u>	<u>Function</u>
Menu	Go to Programming Mode or leave Programming, Advanced Features, and Max/Min Modes.
Right Arrow	Move to next digit.
Up Arrow	Move to next selection or increment digit.
Enter/Ack	Accept selection/value and move to next selection.

Right Arrow & Menu simultaneously enters Advanced Features

Max/Min Mode

While in Run Mode, pressing **Up Arrow** will initiate Max/Min Mode. **Up Arrow** toggles between Max & Min displays, and **Right Arrow** resets the Max/Min to the current value. Press **Menu** or wait 10 seconds to return to Run Mode. Pressing **Enter/Ack** will disable the 10 second timeout and continuously display Max or Min.

Press **Right arrow** and **Menu** to access Advanced Features Menu

When the meter is locked, Adjust, Filter and Bypass can only display their settings, and the Copy and ICAL functions are not available.

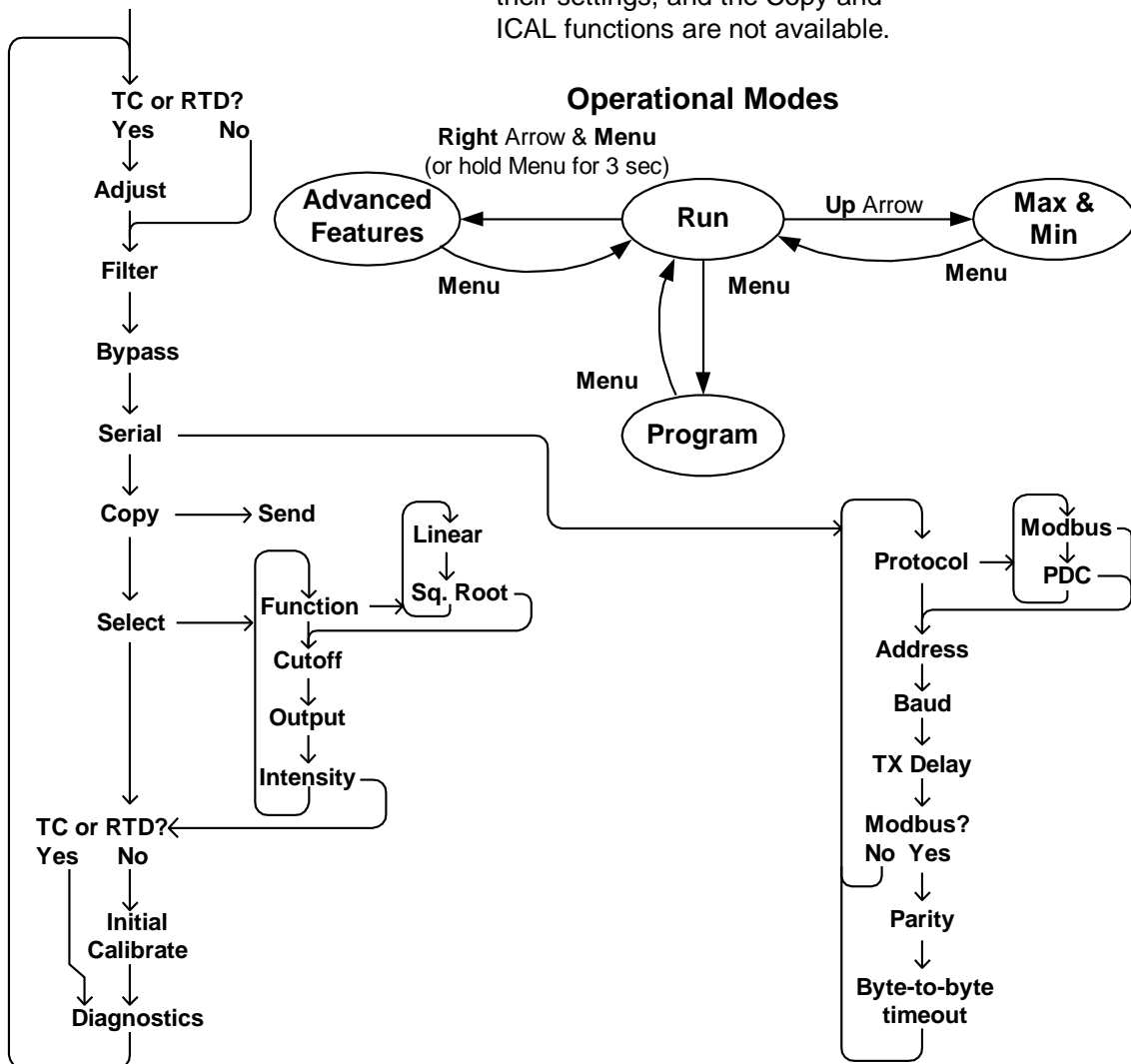

Complete Product Line of Displays and Controllers IN ALL SHAPES, SIZES & LOCATIONS



Big, Bright Displays
For Indoor or Outdoor
in Bright Sunlight



Large Dual-Line
6-Digit Display



24 VDC
Transmitter
Power Supply



MeterView® Pro USB
Programming Software



Universal 85-265
VAC or 12-24 VDC
Input Power
Options



4-20 mA, 0-10 V,
Thermocouple, RTD,
Strain Gauge, High
Voltage, & Modbus Inputs



Up To Four
3 A Form C
Relays (SPDT)



SP Ex IECEx CE

UL

UL CE

EXPLOSION-PROOF ProtEX-MAX Series

- NEMA 4X, IP68 Rated Enclosure
- CapTouch Through-Glass Buttons
- Operating Temperature of -55 to 65°C
- Worldwide Approvals

LARGE DISPLAYS Helios Series

- 1.8" Digits Readable From 100 Feet
- NEMA 4X, IP65 Rated Enclosure
- Operating Temperature of -40 to 65°C
- Now UL and C-UL Approved!

PANEL METERS ProVu Series

- NEMA 4X, IP65 Rated Front
- Programmable Function Keys
- UL, C-UL, and CE Approvals
- 1/8 DIN Size

Go to PREDIG.COM for details on ProVu, ProtEX-MAX and Helios Series Meters

Contact Precision Digital

Technical Support

Call: (800) 610-5239 or (508) 655-7300

Email: support@predig.com

Sales Support

Call: (800) 343-1001 or (508) 655-7300

Email: sales@predig.com

Place Orders

Email: orders@predig.com

For the latest version of this manual please visit

www.predig.com

PRECISION DIGITAL CORPORATION

233 South Street • Hopkinton MA 01748 USA

Tel (800) 343-1001 • (508) 655-7300

www.predig.com

