

Fox Thermal

**THERMAL MASS FLOW METER
& TEMPERATURE TRANSMITTER**



Model FT1



Notice

This publication must be read in its entirety before performing any operation. Failure to understand and follow these instructions could result in serious personal injury and/or damage to the equipment. Should this equipment require repair or adjustment beyond the procedures given herein, contact the factory at:

**FOX THERMAL INSTRUMENTS, INC.
399 RESERVATION ROAD
MARINA, CA 93933
TELEPHONE: 831-384-4300
FAX: 831-384-4312
EMAIL: SERVICE@FOXTHERMAL.COM**

**Download Technical Data Sheets from our website:
www.foxthermal.com**

Fox Thermal Instruments, Inc. (Fox Thermal) believes that the information provided herein is accurate; however, be advised that the information contained herein is NOT a guarantee for satisfactory results. Specifically, this information is neither a warranty nor guarantee, expressed or implied, regarding performance, merchantability, fitness, or any other matter with respect to the products; nor recommendation for the use of the product/process information in conflict with any patent. Please note that Fox Thermal reserves the right to change and/or improve the product design and specification without notice.



Fox Thermal FT1 Manuals:

- **Fox Thermal FT1 View™ Manual**





All Fox Thermal Manuals and software available in English only.

Table Of Contents

1. Introduction	Page 4
a. Quick Start Guide	Page 4
b. Menu Trees	Page 6
c. General	Page 14
2. Installation (Mechanical)	Page 17
a. Lateral Placement	Page 18
b. Welding Branch Outlet to Pipe (Insertion)	Page 20
c. Installation Depth	Page 21
d. Orientation	Page 22
e. Mounting Instructions	Page 24
f. Retractor Installation	Page 19
3. Wiring (Electrical)	Page 29
a. Wiring Access	Page 29
b. Input Power	Page 31
c. Signal Wiring	Page 32
d. Pulse/Alarm Wiring (optional feature)	Page 34
e. RS485 Wiring: Modbus RTU or BACnet MS/TP (optional feature)	Page 36
f. HART wiring	Page 37
4. Operation (Standard Operation)	Page 40
a. Start Up	Page 40
b. Programming	Page 42
c. CAL-V™	Page 60
d. Gas-SelectX®	Page 63
5. Communication Protocols	Page 21
a. Modbus RTU (RS485)	Page 21
b. BACnet MS/TP (RS485)	Page 78
c. HART	Page 82
6. Maintenance	Page 88
a. Safe Meter Removal from Retractor	Page 90
b. Troubleshooting	Page 94
7. Appendices	Page 99
a. Specifications	Page 99
b. Agency Approvals	Page 101
c. Dimensions	Page 102
d. Warranty	Page 103
e. Returning your meter	Page 107
8. Definitions	Page 108
9. Index	Page 109

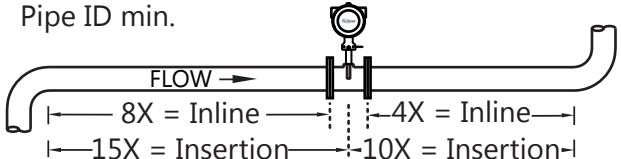
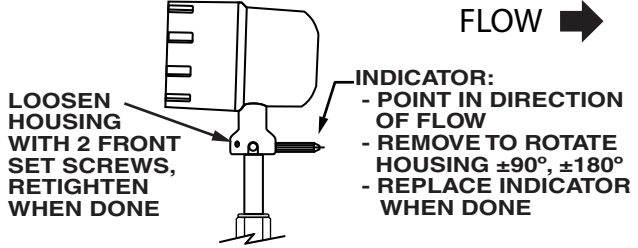
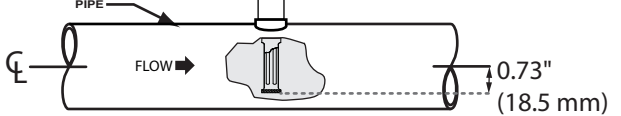
Use the table and images below as a guide while using the worksheet on the next page to record your notes.

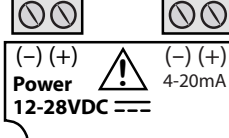
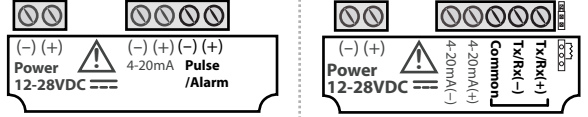
NOTE! Please read the entire quick-start procedure before beginning installation.

1.	Record inside diameter (ID). Ensure the actual pipe ID matches the pipe ID shown on the factory calibration certificate. If IDs do not match, refer to p. 54.	
2.	Record upstream and downstream straight-pipe requirements based on Pipe ID and meter style (insertion/inline). [refer to p. 18 for more information]	
3.	a. The Flow Direction Indicator must point in the direction of flow. b. The Indicator can also be used to change the orientation of the housing for a better view of the meter's display. Note that the 2 set screws must be loosened. [refer to p. 22 for more information]	 <p>INDICATOR:</p> <ul style="list-style-type: none"> - POINT IN DIRECTION OF FLOW - REMOVE TO ROTATE HOUSING ±90°, ±180° - REPLACE INDICATOR WHEN DONE
4.	Ensure correct probe depth setting. If using 1 ½" size pipe, please see note on p. 21.	
5.	Open the housing. If needed, the orientation of display can be rotated in 90° increments for a better view. [refer to p. 23 for more information]	 <p>ACCESS DISPLAY BY UNSCREWING COVER</p> <p>REMOVE SCREWS ON DISPLAY TO ROTATE DISPLAY ±180°</p>
6.	Ensure power wiring and 4-20mA wiring are properly connected [refer to p. 31 - p. 33 for more information]	 <p>Power 12-28VDC</p> <p>4-20mA</p>
7.	Verify the output signal wiring based on model type (Pulse/Alarm or communication protocol) [refer to p. 34-p. 36 for more]	 <p>Power 12-28VDC</p> <p>4-20mA</p> <p>Pulse /Alarm</p>
8.	Power on the flow meter	
9.	Check the remaining flow meter settings by accessing the meter settings either through the front panel of the display or by using the FT1 View™ software tool. Record the settings in the spaces given for items A - E on the following page.	

Quick Start Guide

Before powering on your meter, use this worksheet to record your notes.

	Item to verify	Serial Number:	Serial Number:	Serial Number:	Serial Number:
1.	What is the Pipe ID?	ID =	ID =	ID =	ID =
2.	Calculate the Upstream/Downstream straight-pipe requirements	UP = DN =	UP = DN =	UP = DN =	UP = DN =
3.	a. Is the flow indicator pointed in direction of flow?	Y / N	Y / N	Y / N	Y / N
	b. Has housing been rotated to view display?	Y / N	Y / N	Y / N	Y / N
4.	Is the probe depth setting correct?	Y / N	Y / N	Y / N	Y / N
5.	Has display been rotated for viewing?	Y / N	Y / N	Y / N	Y / N
6.	Verify proper power wiring				
7.	Verify proper output wiring				

After powering on your meter, check items A - E below by accessing the meter settings either through the front panel of the meter's display or by using the FT1 View™ software tool.

A.	Which flow units have been set in meter? (SCFM, KG/H, etc..)				
B.	Correct values for reference temperature and pressure?	Y / N	Y / N	Y / N	Y / N
C.	Confirm the pipe ID above to "Pipe_id="				
D.	Verify the 4mA and 20mA meter settings	4mA = 20mA =	4mA = 20mA =	4mA = 20mA =	4mA = 20mA =
E.	Confirm the correct gas is in the Gas-SelectX® Menu				

Your Notes:

If you are experiencing any problems after completing this procedure, please call the Fox Thermal Service Department at 831-384-4300 to review this information.

Introduction: Menu Trees

Fig. 1.1: FT1 Menu Tree - Main Menu

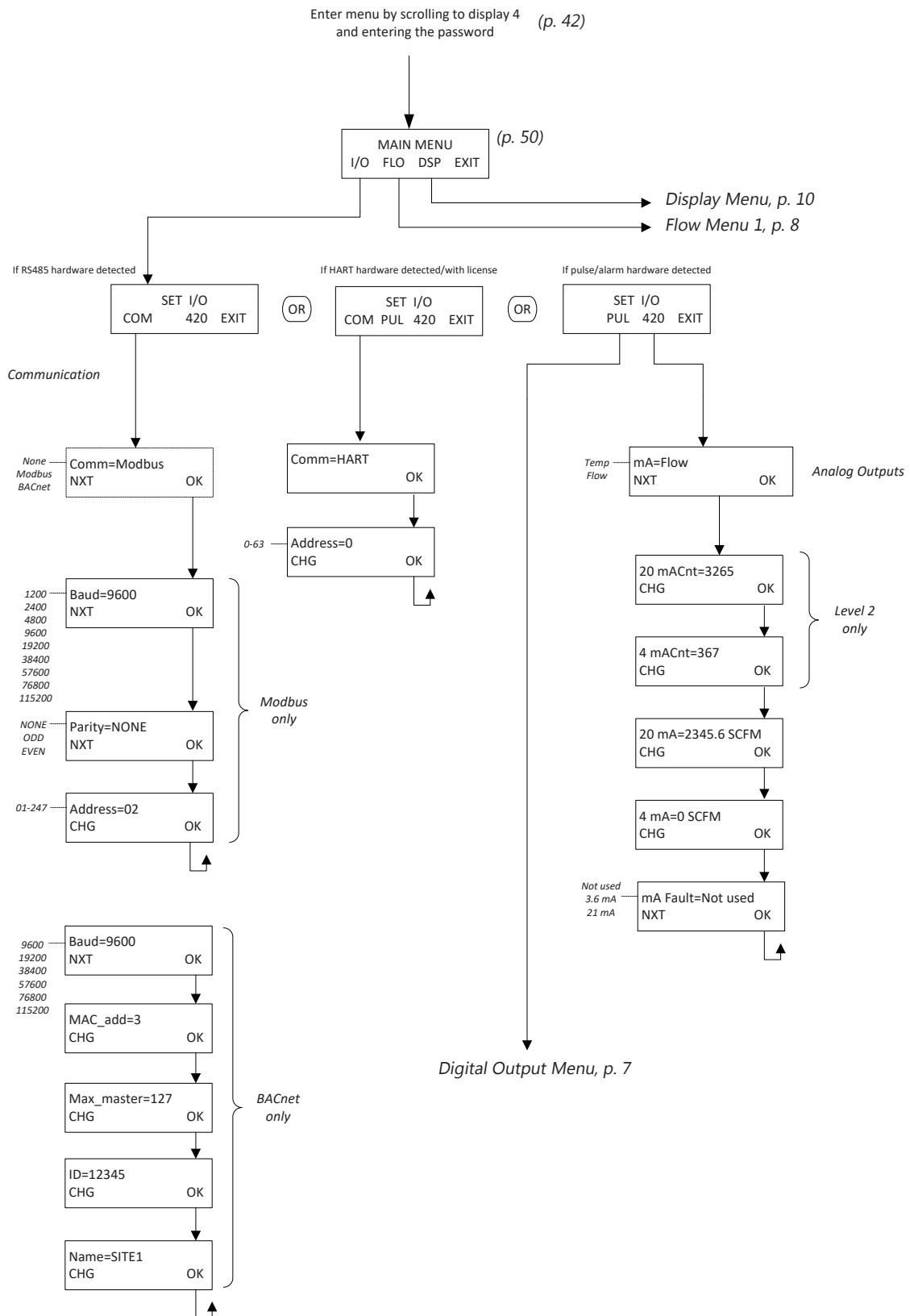

Introduction: Menu Trees

Fig. 1.2: FT1 Menu Tree - Digital Output

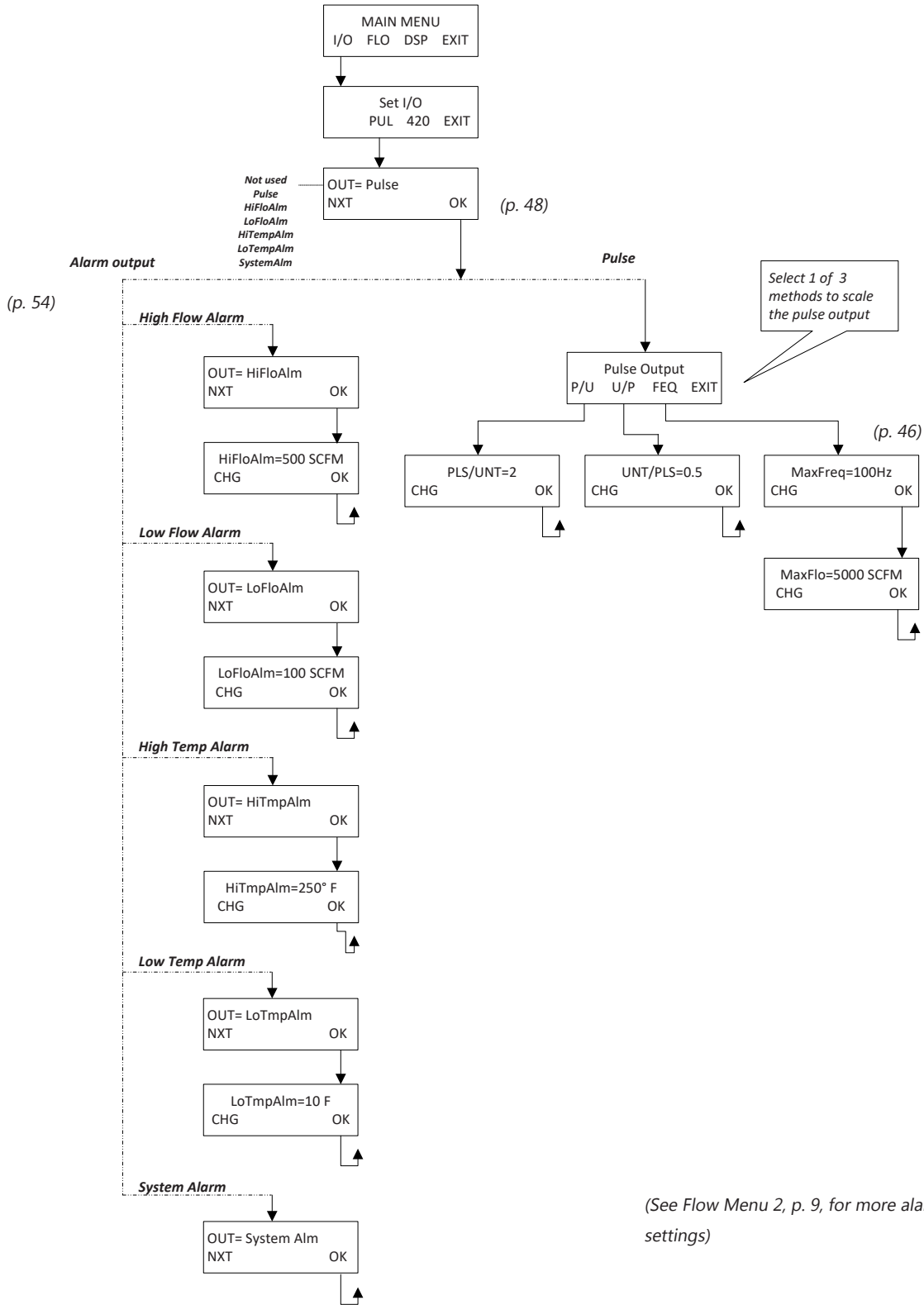

(See Flow Menu 2, p. 9, for more alarm settings)

Fig. 1.3: FT1 Menu Tree - Flow Menu 1

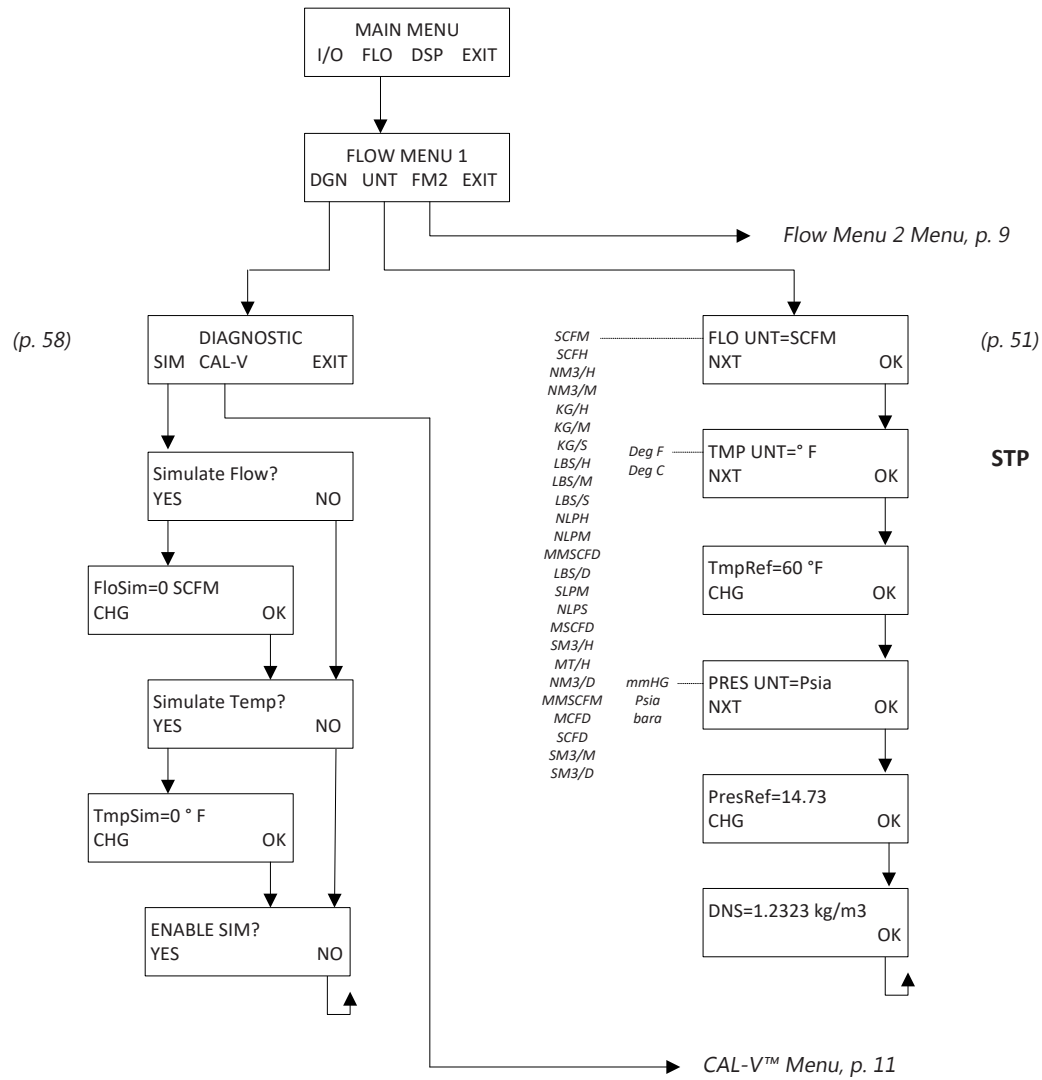

Introduction: Menu Trees

Fig. 1.5: FT1 Menu Tree - Display Menu

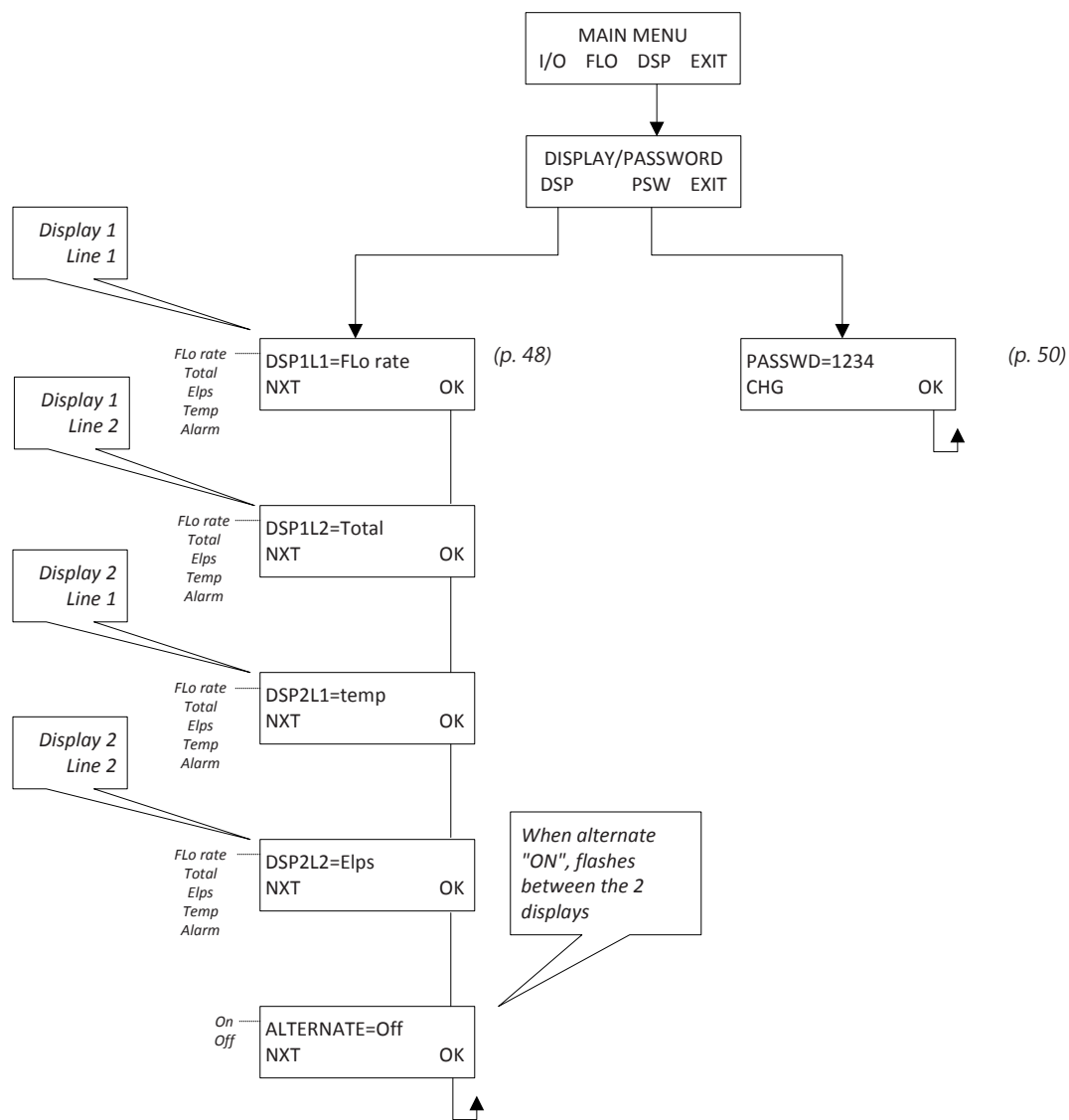

NOTE! All readings updated every second

- Flo Rate = Flow rate of process gas
- Total = Total flow of process gas
- Elps = Elapsed time since reset of flow total
- Temp = Temperature of process gas
- Alarm = Notification of errors; diagnostic errors

Introduction: Menu Trees

Fig. 1.6: FT1 Menu Tree - CAL-V™ Menu

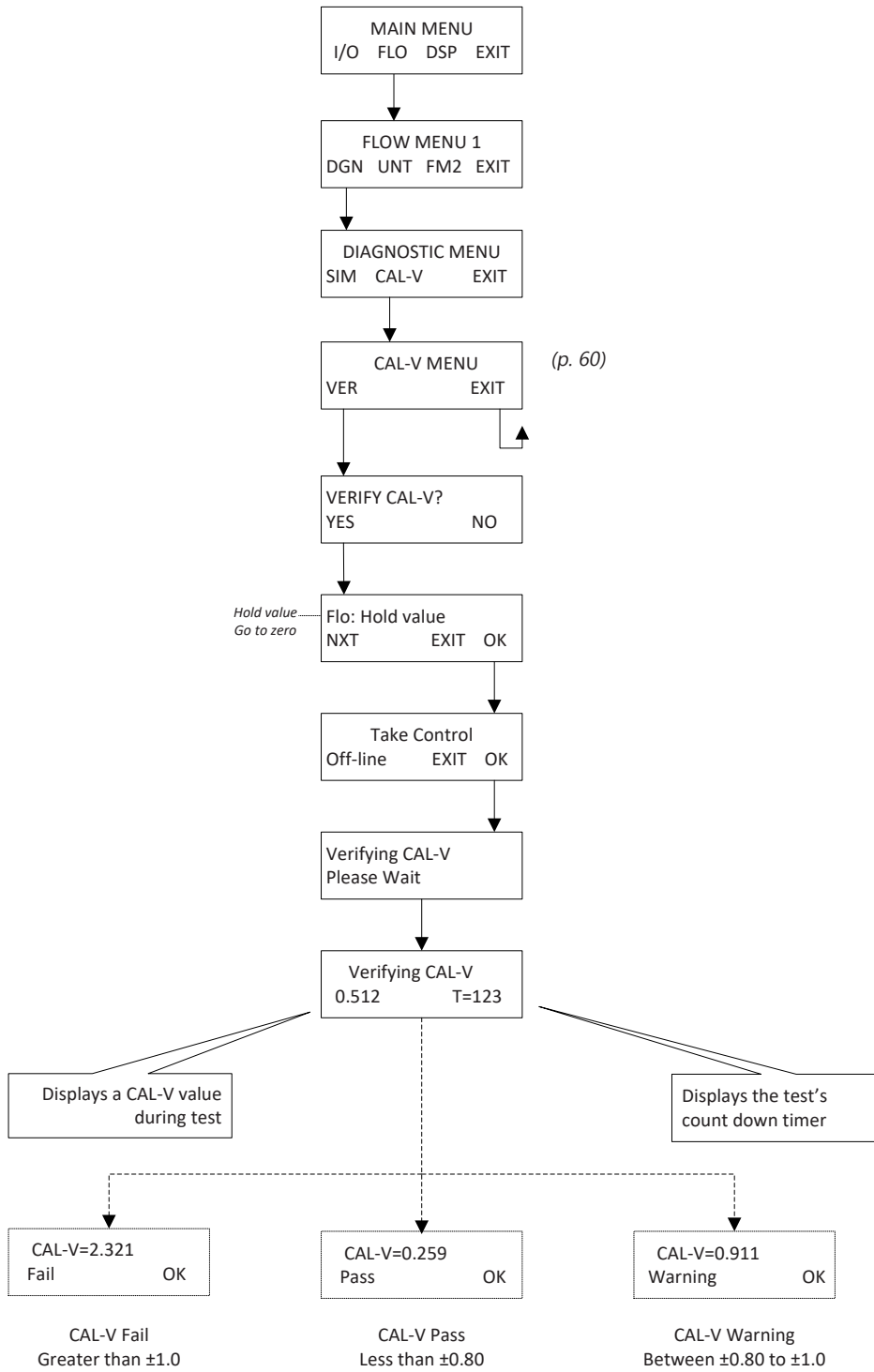
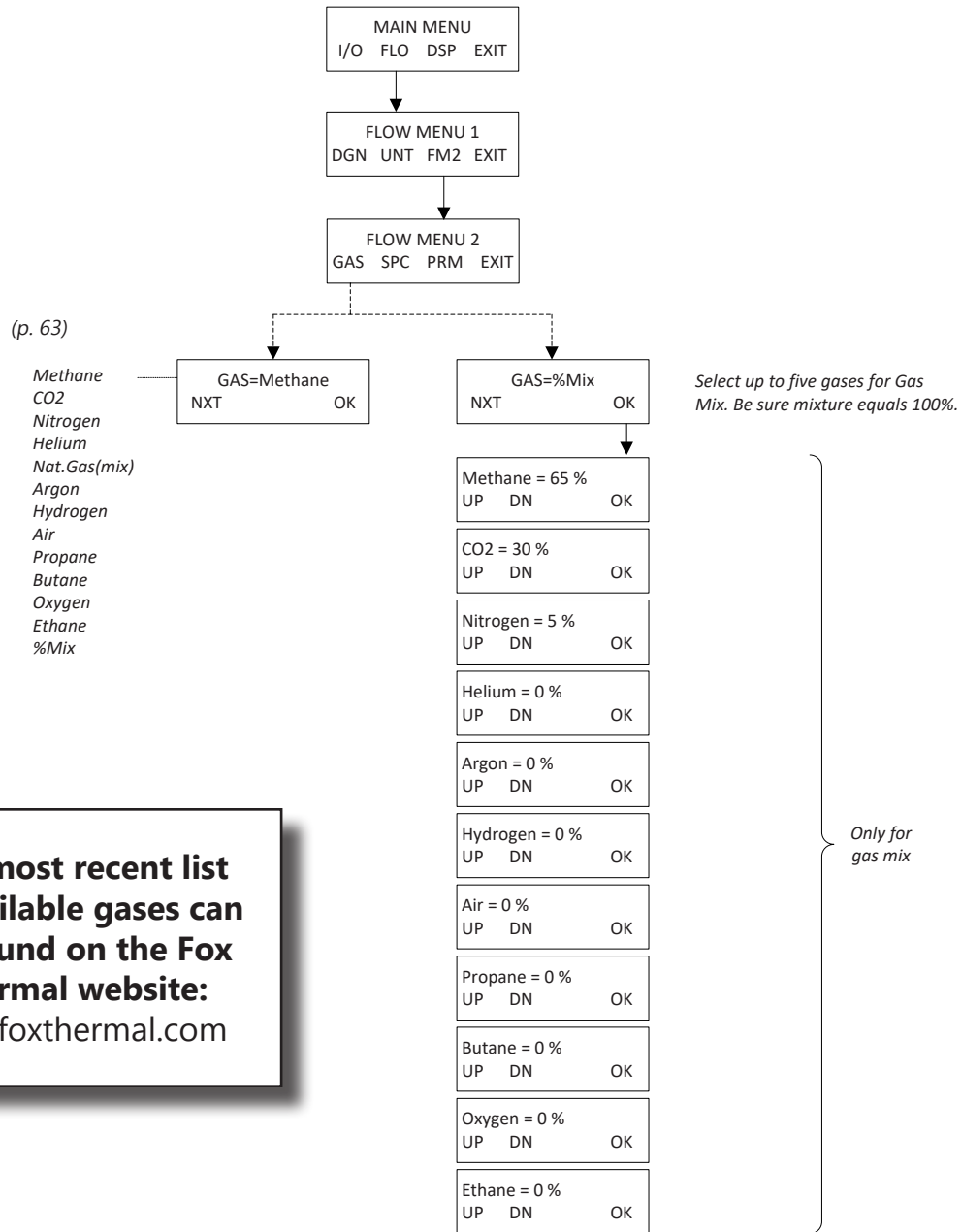

Fig. 1.7: FT1 Menu Tree - Gas-SelectX[®] Menu



The most recent list of available gases can be found on the Fox Thermal website: www.foxthermal.com

Gas Mix (100%) OK

OR

Err: Mix=(110%) OK

OR

Err: Max 5 gas OK

Shows only if no error is detected. Pressing OK allows exit to menu.

Shows only if gas mix does not equal 100%. Pressing OK returns to gas entry.

Shows only if too many gases are selected. Only five (5) gases are allowed. Pressing OK returns to gas entry.

Introduction: Menu Trees

Fig. 1.8: FT1 Menu Tree - Engineering Display

Enter: Press F1 & F2 at the same time
Press F4 to return to normal mode

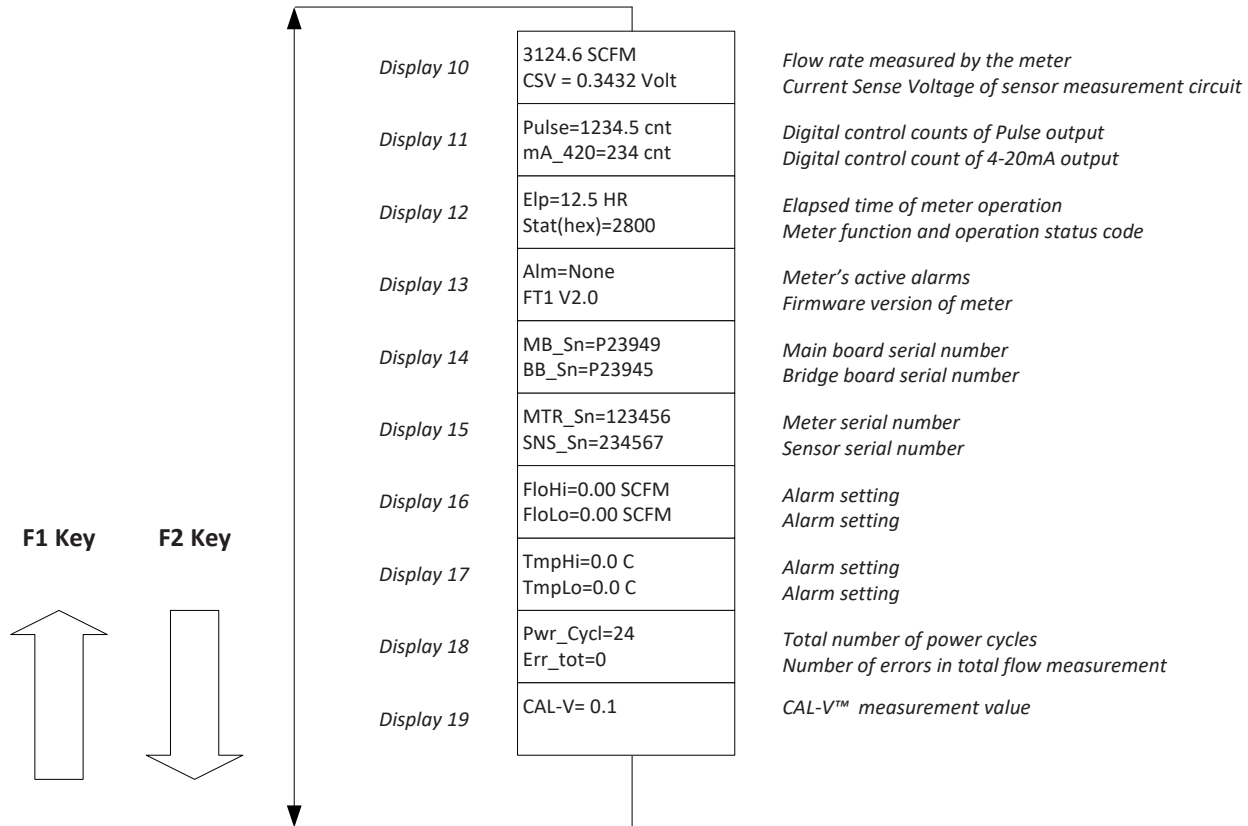

F3 & F4 pressed at the same time will
initiate a "Total" reset

Welcome

Thank you for purchasing the Model FT1 Thermal Gas Mass Flow Meter from Fox Thermal. The Model FT1 is one of the most technically advanced flow meters in the world. Extensive engineering effort has been invested to deliver advanced features, accurate measurement performance and outstanding reliability.

This Instruction Manual contains the electrical and mechanical installation instructions as well as details for programming, maintaining and troubleshooting the meter. This manual is divided into the following sections: Introduction, Installation, Wiring, Operation, Maintenance, Troubleshooting, Appendices, Glossary and Index.

Theory of Operation

The Model FT1 is an innovative Thermal Mass Gas Flow Meter and Temperature Transmitter. It is microprocessor-based and field programmable. The FT1 thermal sensor operates on the law that gases absorb heat. A heated sensor placed in an air or gas stream transfers heat in proportion to the stream's mass velocity. There are two sensor elements. One sensor element detects the gas temperature and a second element is maintained at a constant temperature above the gas temperature. The energy transferred from the heated element is proportional to the mass flow velocity. The FT1 flow meter maintains accurate flow measurement over a large temperature and pressure range.

Mass Flow

The Model FT1 measures mass flow; an advantage over other flow meters which measure volumetric flow rate. Volumetric flow is incomplete because temperature and pressure are unknown and must be measured separately. For example, the mass flow of a gas depends on its temperature and pressure. As temperature and pressure changes, the gas volume changes but not its mass. Therefore a device measuring mass flow is independent of temperature and pressure changes. The Model FT1 provides a direct measurement of gas flow in Mass units (kg/hr, lb/hr), standard units (SCFM, SLPM) or normal units (NM3/hr, NLPM) with no additional temperature or pressure measurements required.

Flow Calibration

The Fox Thermal Calibration Lab maintains instrument calibration data on every flow meter. Calibration files include details on process conditions, customer gas, line size and other information. All NIST-traceable equipment utilized for the calibration procedure is identified on the Calibration Certificate, which is sent with every flow meter.

Introduction

Calibration Validation

Validate the calibration of the FT1 in the field using the CAL-V™ test. The goal of Calibration Validation is to provide operators with the ability to verify that the meter is capturing accurate data at scheduled recalibration times - or at any time - instead of sending the meter back to the factory for recalibration. By performing CAL-V™ in the field, operators can verify that the meter is running accurately by testing the functionality of the sensor and its associated signal processing circuitry. This test can be done in the pipe under normal processing conditions.

DDC-Sensor™ Technology Description

The 2nd Generation Fox Thermal DDC-Sensor™ is a new state of the art sensor technology used in the Fox Thermal Model FT1 Thermal Gas Flow Meter. The DDC-Sensor™, a Direct Digitally Controlled sensor, is unlike other thermal flow sensors available on the market. Instead of using traditional analog circuitry, the DDC-Sensor™ is interfaced directly to the FT1 microprocessor for more speed and programmability. The DDC-Sensor™ quickly and accurately responds to changes in process variables by utilizing the microprocessor to determine mass flow rate, totalized flow, and temperature.

Fox Thermal's DDC-Sensor™ provides a technology platform for calculating accurate gas correlations. The FT1 correlation algorithms allow the meter to be calibrated on a single gas in the factory while providing the user the ability to select other gases in the Gas-SelectX® Gas Menu. Fox Thermal's Model FT1 with its DDC-Sensor™ and state-of-the-art correlation algorithms provide an accurate, multi-gas-capable thermal gas flow meter.

I/O Description

The FT1 features a galvanically isolated 4-20mA analog output with HART communication option and a second output for pulse, Modbus RTU (RS485) or BACnet MS/TP (RS485). There is also a USB port for interfacing with a laptop or computer. The 4-20mA output can be configured for flow rate or process gas temperature and can be scaled by the user. The pulse output can be used for pulse or alarm, is programmable to represent flow rate and can be scaled for maximum flow/maximum frequency, units-per-pulse or pulse-per-units. The maximum frequency is 100 Hz.

FT1 View™ interfaces to the USB port and is a free PC-based software program that displays flow meter readings and permits flow meter configuration. The software is available for download on the Fox Thermal website. Industry standard communication options are available including optional Modbus RTU (RS485), BACnet MS/TP (RS485), or HART.

Introduction

FT1 Functional Diagram

An on-board 2 line x 16 character backlit LCD display shows flow rate, total flow, elapsed time, process gas temperature, and alarms. The display is also used in conjunction with the Configuration Panel for field configuration of flow meter settings such as 4-20mA scaling, frequency output scaling, pipe area, zero flow cutoff, flow filtering or dampening, display configurations, diagnostics, and alarm limits.

Fig. 1.9: FT1 Function Diagram

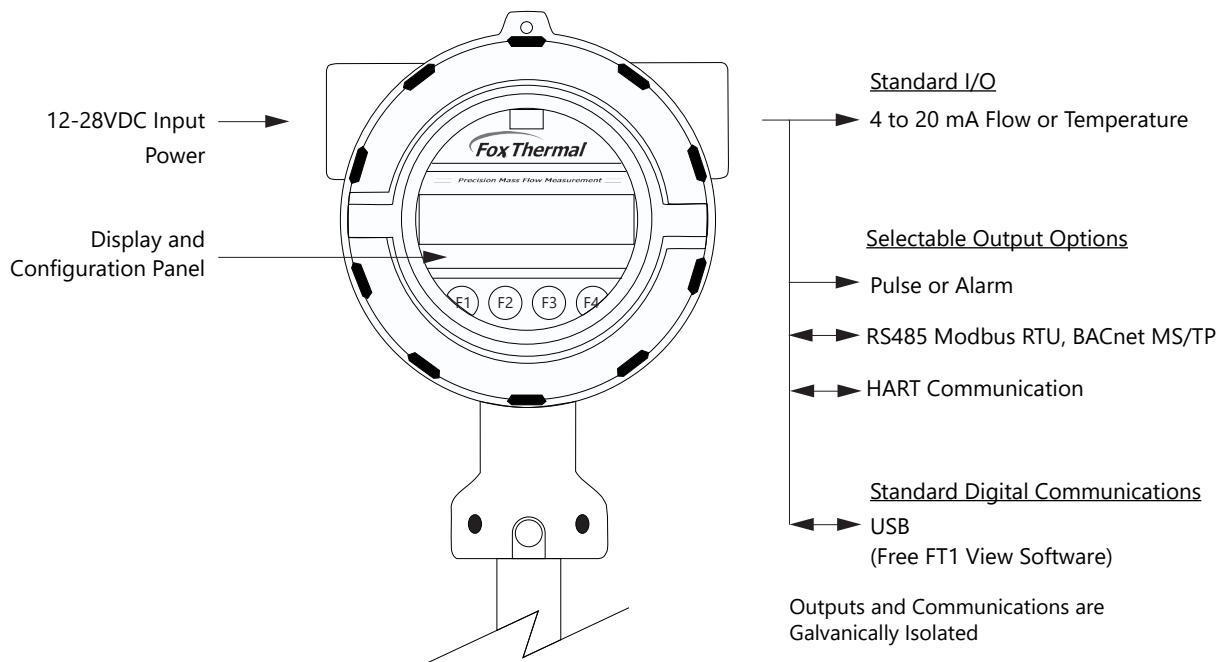

Specific Conditions of Use:

- The flameproof joints of the equipment are not intended to be repaired. Consult the manufacturer if dimensional information on the flameproof joints is necessary.
- Follow the manufacturer's instructions to reduce the potential of an electrostatic charging hazard.

Installation

Installation Scope

This section describes how to install the Fox Thermal Model FT1 Flow Meter and how to get started. Installation methods will vary according to the flow meter type (insertion or inline).

For Insertion Types:

1. Determine lateral position on the pipe
2. Determine if tilted installation is needed due to moisture or condensation in the gas
3. Verify sensor installation depth
4. Determine sensor orientation in relation to sensor length and direction of flow
5. Determine if the display orientation must be changed
6. Ensure proper tightening of compression fitting for mounting meter

For Inline Types

1. Determine lateral position on the pipe
2. Determine if tilted installation is needed due to moisture or condensation in the gas
3. Ensure the correct flow body orientation in relation to direction of flow in pipe
4. Determine if the display orientation must be changed
5. Ensure proper tightening of compression fitting for mounting meter

Installation procedures must be performed using a combination of the end user's best engineering practices, in compliance with local codes, and manufacturer's recommendations.

General Precautions

The following general precautions should be observed:



1. Exercise care when handling the flow meter to avoid damaging the probe, sensor or enclosure.
2. Close any unused conduit openings in the enclosure with plugs certified for your application.
3. The enclosure cover must be closed except during installation or configuration.
4. Mounting FT1 in direct sunlight can cause the temperature inside the enclosure to increase beyond design limits, resulting in failure of LCD display and reduced component life. It is recommended that a sunshade be installed to avoid direct sunlight (see maximum enclosure operating temperature specification).
5. Ensure the flow direction indicator/pointer for the meter is in line with the direction of flow in the pipe.
6. Do not install the FT1 enclosure near an igniter, igniter-controller or switching equipment.
7. Do not install an external power supply in a cabinet containing an igniter controller or switching equipment.
8. For accurate flow measurement: review flow meter placement instructions before installation to ensure a proper flow profile in the pipe.
9. For safety reasons, Teflon ferrules are only appropriate for applications with pressures of 60 psig or less. At higher pressures, use of a Teflon ferrule risks unwanted probe movement or ejection of the probe from the pipe. For all applications above 60 psig, the standard stainless steel ferrule is required.

Installation

Instructions for Flow Meter Lateral Placement

Install the Model FT1 flow meter so that it is far enough away from bends in the pipe, obstructions, or changes in line sizes to ensure a consistent flow profile. See Fig. 2.1 below for your meter type (insertion/inline).

Fig. 2.1: Upstream and Downstream Pipe IDs for Flow Meters

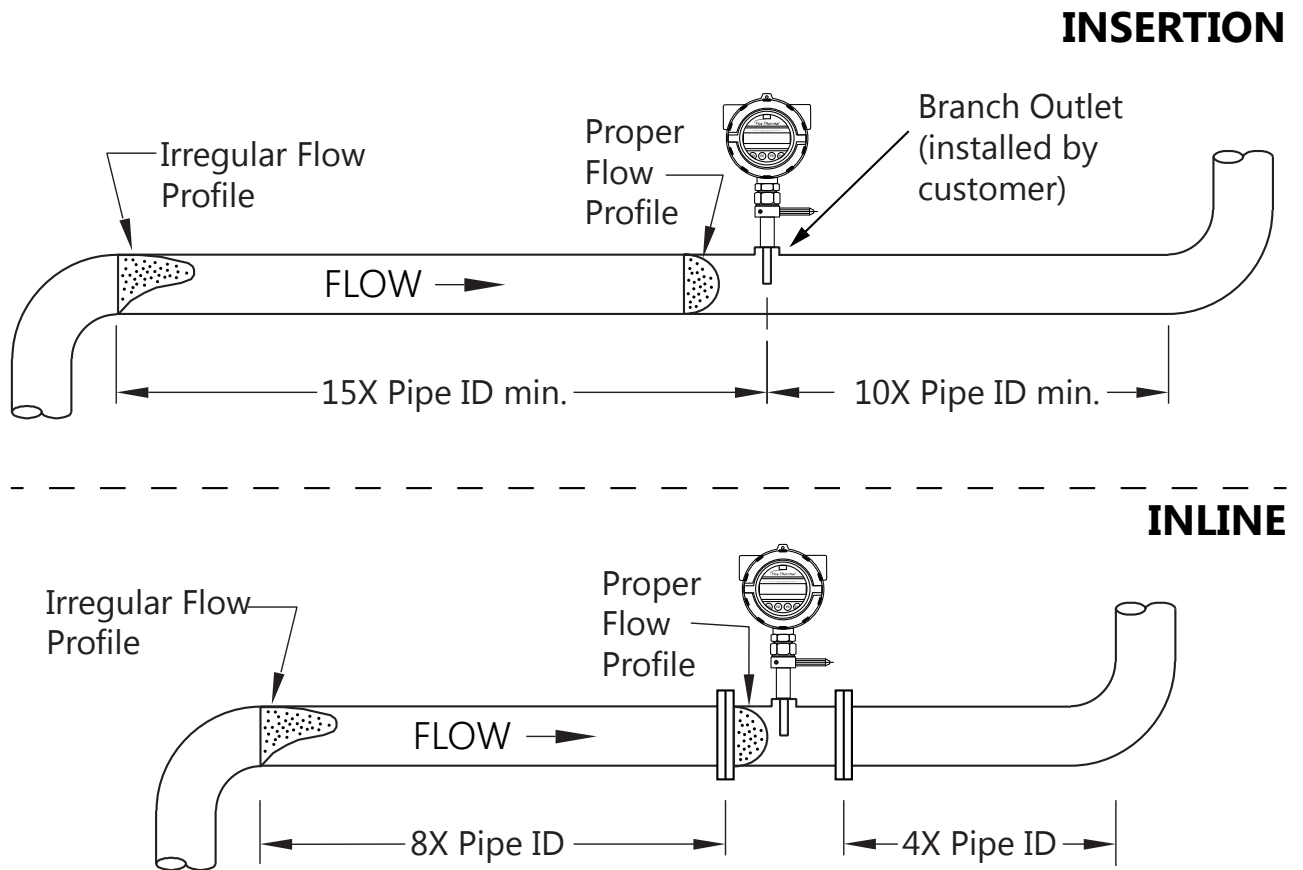

NOTE!

- ID = Inside Diameter
- The probe diameter is $\frac{3}{4}$ "
- An irregular flow profile will affect sensor accuracy

Installation

Tilt Installations - Moisture in the Gas or Condensation

Tilted variations on installations help prevent moisture and condensation from forming on the sensor and disrupting accurate flow measurement. Fox Thermal recommends 180° installation if the gas may have moisture or condensation, if possible. Contact Fox for further recommendations.

Fig. 2.2: Tilt Installation at 180°

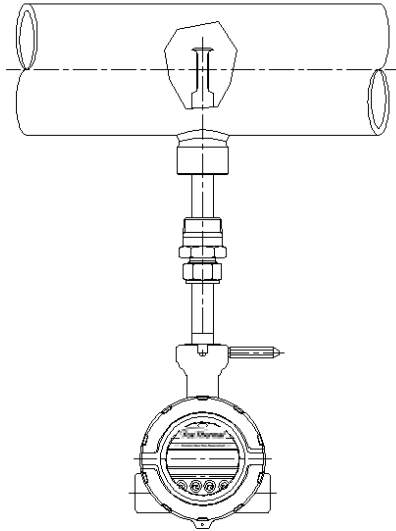

Alternate Installations - Vertical Pipes or Restricted Installation Spaces

When restricted physical installation space exists, the FT1 can also be installed at other angles. Please note that the display and the enclosure orientation can be rotated in 90° increments.

Fig. 2.3: Alternate Installation at 90° (CCW)

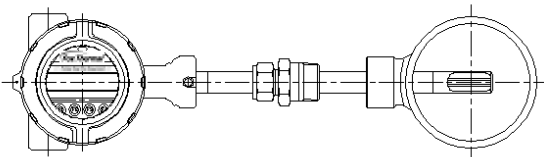

Installation

Welding NPT Female Fitting to Pipe

The probe of the FT1 must be installed perpendicular in the pipe to measure flow accurately. Use the following steps to ensure that the 1" NPT female fitting is correctly welded to the pipe. Directions:

1. Drill a 0.781" (25/32") hole inside the fitting through the wall of the pipe (1 wall only).
2. Assemble the compression fitting and NPT fitting hand tight onto the probe of the FT1.
3. Insert the probe into the hole in the pipe and use the FT1 probe and compression fitting to align the NPT fitting with the hole and the probe perpendicular to the pipe.
4. Tack-weld the NPT female fitting carefully onto the pipe.
 - Before welding the fitting completely, verify the probe is aligned to the center of the pipe and the hole is centered in the NPT fitting (see Figure 2.4).
5. To verify that the correct hole position has been achieved, carefully slide the 0.75" sensor in and out of the NPT female fitting and 0.781" hole.



WARNING! Do not force the 0.75" sensor through the 0.781" hole. Forcing it through the 0.781" hole can damage the probe.

6. Verify that the temporary weld of the NPT female fitting positions the probe window on the pipe's centerline.
 - Figure 2.4 shows an incorrect welding of the NPT female fitting, causing the 0.75" sensor to be "off center".
7. Once the NPT fitting is aligned properly, remove the 0.75" sensor from the NPT female fitting and finish welding. Then verify the probe is still aligned with the center of the pipe.
8. Set the depth of the flow meter (see "Fig. 2.5: Cross Section of Insertion Sensor Depth in Pipe" on page 21).

Do not tighten Swage fitting until proper depth of flow meter is determined. See Fig. 2.5.

Fig. 2.4: Alignment of NPT Female Fitting

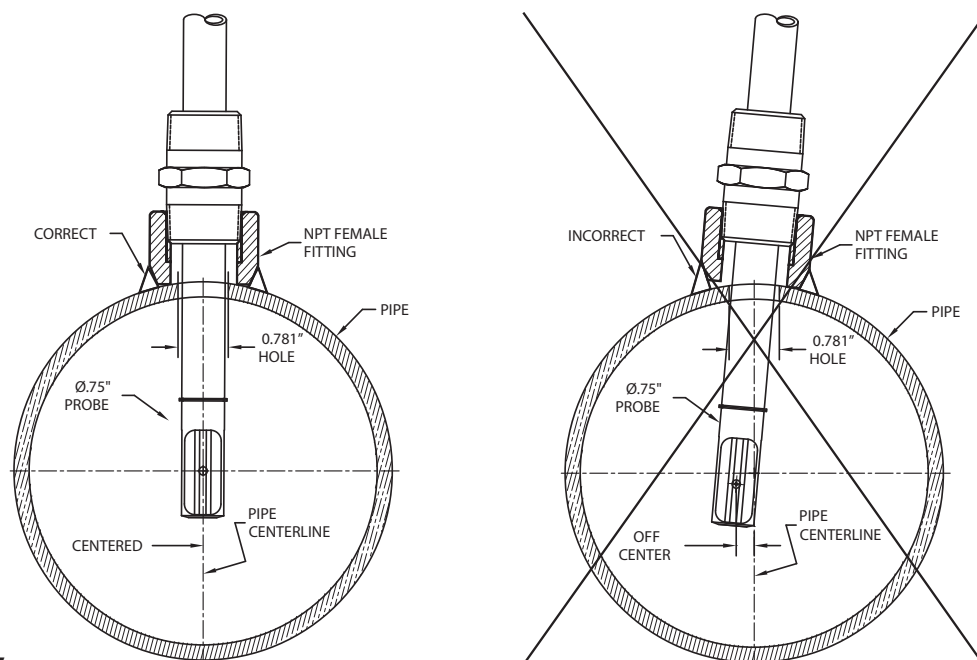

Installation

Installation Depth

The installation depth of the sensor in the pipe is dependent on the pipe size. To get the most accurate reading, proper placement of the sensor window within the pipe is necessary. As shown in Fig 2.2, the end of the sensor window should be 0.73" (18.5 mm) past the center line of the pipe. Review the dimensional drawing below with the following equation to calculate insertion depth: $L + D/2 + .73" = \text{insertion depth}$

Fig. 2.5: Cross Section of Insertion Sensor Depth in Pipe

NOTE! For 1½" (38mm) pipes, carefully insert the probe so that it reaches the bottom inside of the pipe, then lift up 0.2" (5mm) for proper depth setting.

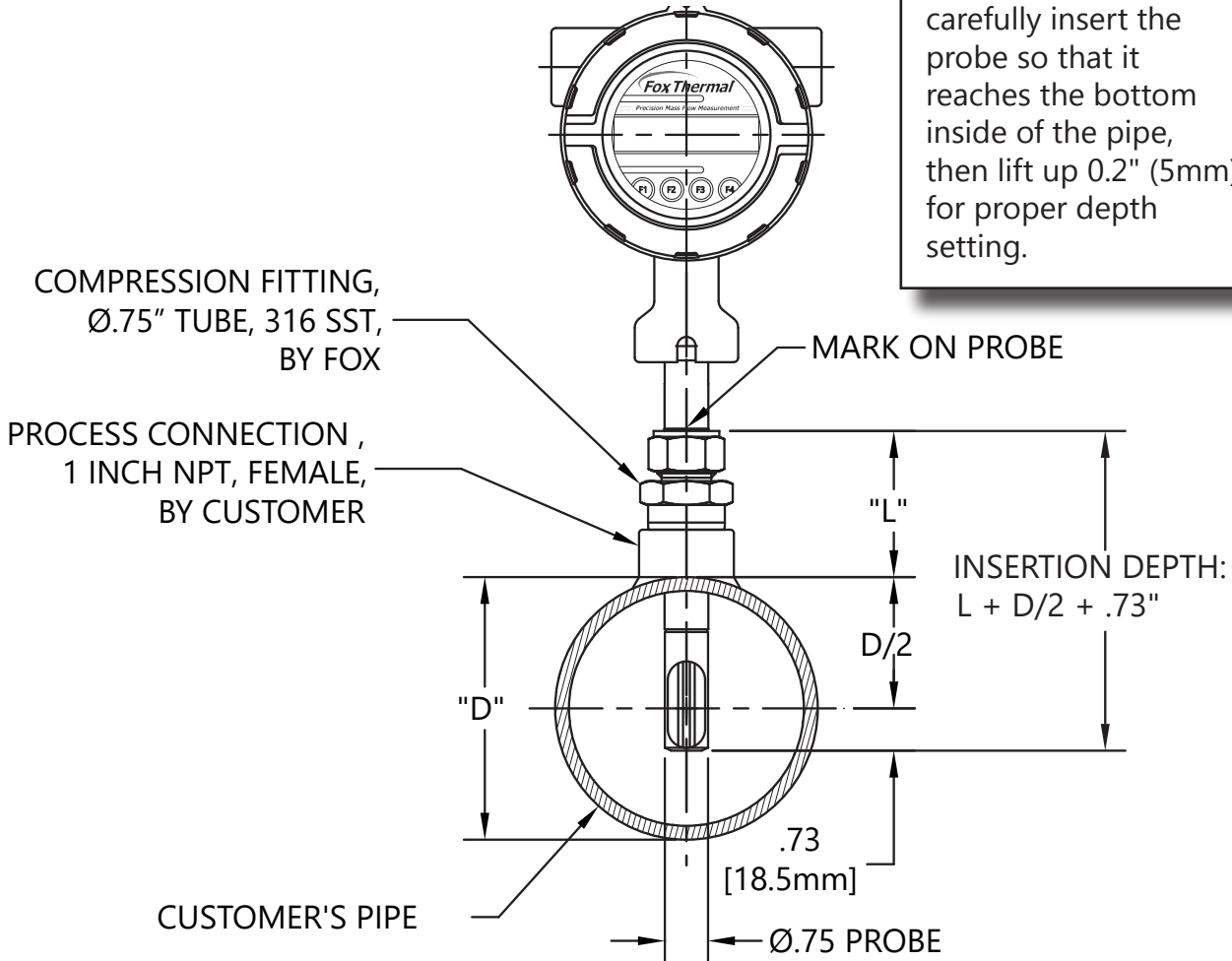

INSTALLATION

Rotating the Enclosure

The Model FT1 has been designed to allow the enclosure to rotate into four positions for optimal viewing of the display. To rotate the enclosure, first loosen the two set screws near the Flow Direction Indicator. Then unscrew and remove the Flow Direction Indicator to allow the enclosure to swivel into the desired position. Then screw the Flow Direction Indicator back into its place, ensure that it points in the direction of flow, and tighten the set screws. See figure 2.6.

Direction of Flow and Orientation of the Probe Sensor

Both the insertion and inline style flow meters come equipped with a flow direction indicator. Install the meter with the flow direction indicator pointing in the direction of flow in the pipe. The alignment of the flow direction indicator is important, it must be less than ± 2 degrees for the most accurate flow measurement.

Fig. 2.6: Orientation of Flow Meter and Rotation of Housing

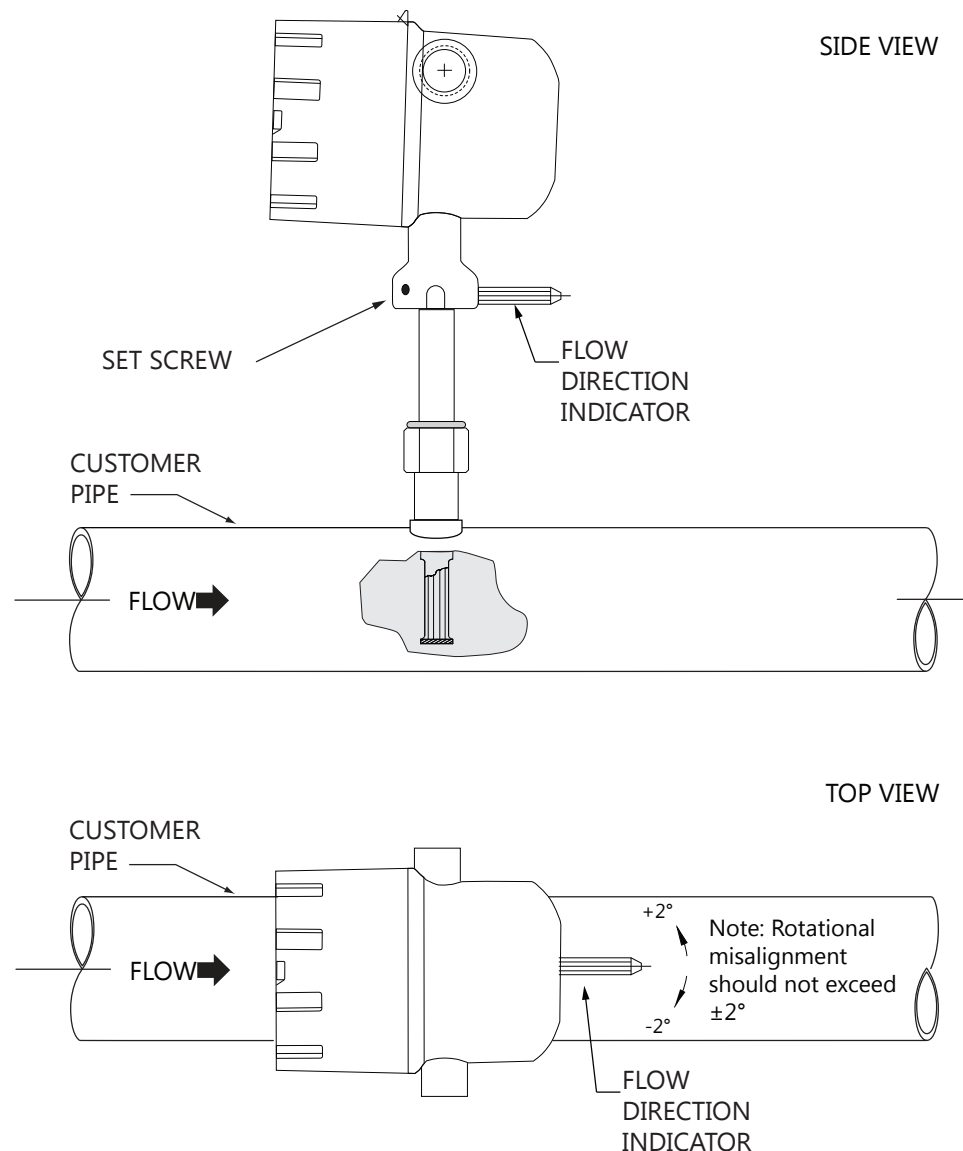

Installation

Changing the Orientation of the FT1 Display

The display can be rotated in 90° increments for optimal viewing of the display. First, open the enclosure by unscrewing the enclosure cap and loosen the two captive phillips screws to open the display assembly. Detach the display board from the metal shield by loosening the three screws on the back of the round shield. Rotate the display board to the desired orientation. Ensure that the display cable is routed flat and straight through the display hinge to prevent binding. Reattach the display board to the metal shield by tightening the three screws. Close the display assembly and secure it to the enclosure with the two captive screws. Finally, install the enclosure cover back on the front of the enclosure.

Fig. 2.7: Rotating the Display

Loosen these two screws to open the display and access wiring terminals.

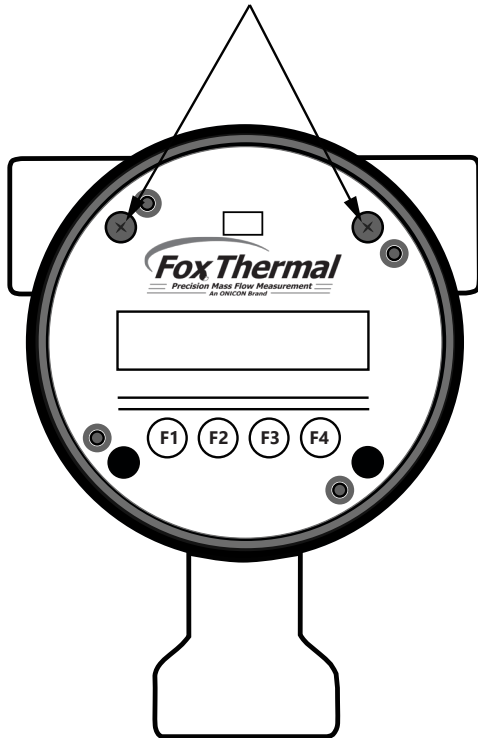

Loosen these three screws to rotate the display in 90° increments ($\pm 180^\circ$).

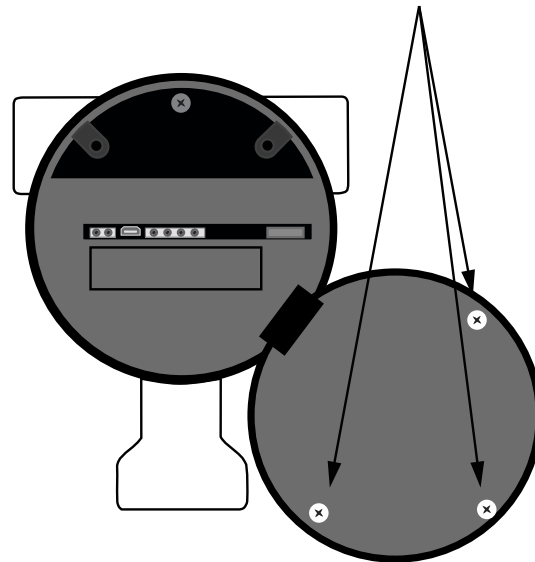

Mounting Instructions - Compression Fittings

The Model FT1 is mounted through a 0.781" (25/32") hole and a 1" female NPT branch outlet provided in the customer's pipe. Insertion style flow meters are not designed for use in pipes smaller than 1½".

- Install the compression fitting into the 1-inch female NPT branch outlet.
- When installing in a 2" pipe or larger, install the end of the probe 0.73" (18.5 mm) past the center line of the pipe and tighten the compression fitting nut (refer to figure 2.5 on p. 21).
- When installing into a 1½" pipe carefully install the probe into the pipe until it touches the opposite wall and pull back 0.2". Tighten the compression fitting nut.
- While holding the fitting body steady, finger tighten the nut. Then, tighten the nut with wrenches an additional one and one-quarter (1 ¼) turn. If beginning at 6 o'clock, the wrench would make one full turn back to 6 o'clock and rest at the 9 o'clock position for proper compression. See Figure 2.5.

Fig. 2.8: Proper Tightening of the Compression Fitting Nut

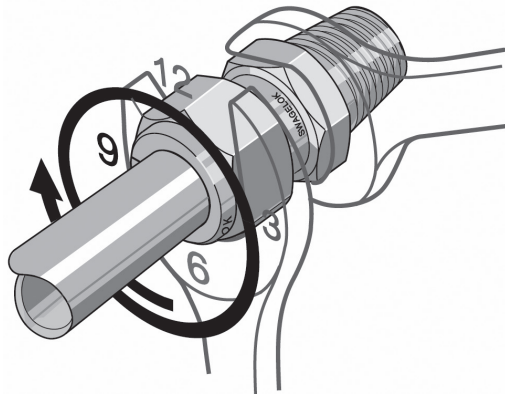

CAUTION! Do not tighten compression fitting without .2" distance from wall or damage to probe will occur.



CAUTION! Once the compression fitting ferrule is locked onto the probe, the probe can be removed or rotated, but the insertion depth is locked in place.



CAUTION! If the stainless steel or teflon ferrules are not properly tightened, and/or the recommended pressure is exceeded, the ferrules can slip on the stainless steel tubing causing damage to the meter or bodily harm.

Installation

Installation of a New Retractor Assembly



NOTE! For instructions on how to properly weld the NPT female fitting onto pipe, please refer to Document #107590.

1. Remove collar clamp from probe using a 3/16" Hex Key.
2. Remove meter probe from retractor assembly and leave the ball valve open.
3. Install the valve assembly on the pipe, by tightening the Hex Nipple with a 1 3/8" wrench.

Fig. 2.9: Retractor Assembly With and Without Probe Inserted

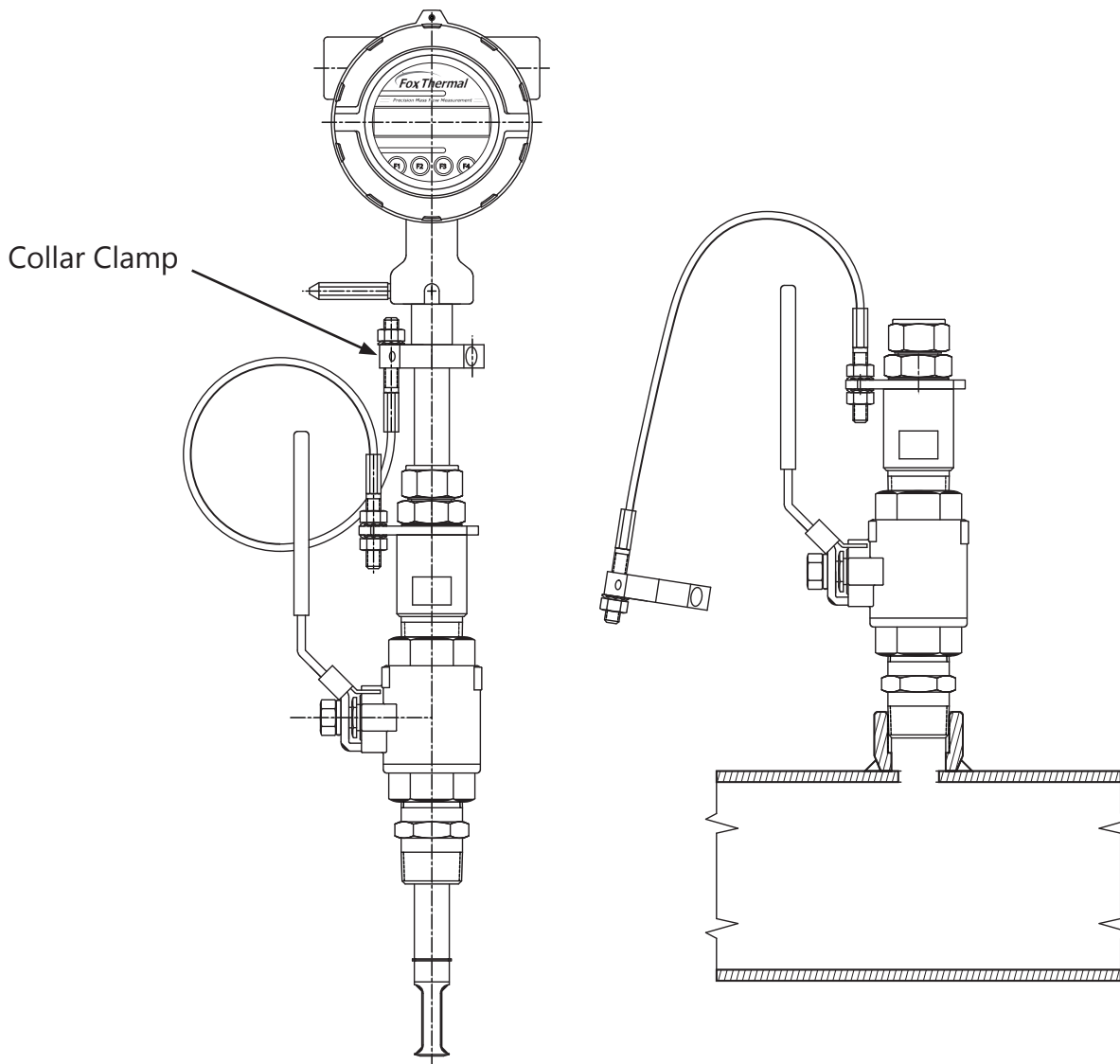

Installation

4. Insert probe into retractor assembly and pipe to verify that the probe will fit through without obstructions. Carefully slide the probe through the retractor assembly and through the hole to see if there is interference by touching the pipe wall on the far side or until the probe cannot go deeper. Remove the retractor and rework the hole, if required.

Fig. 2.10: Verify Probe Insertion

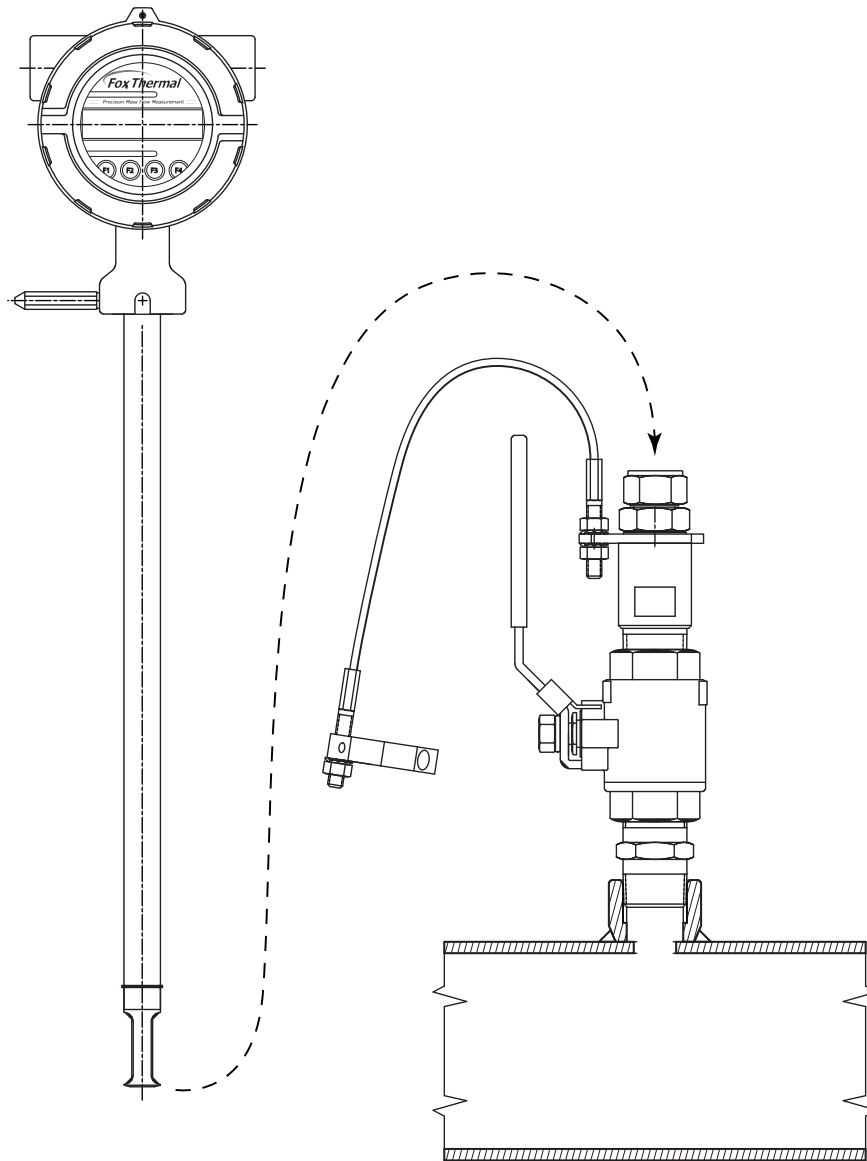

5. Remove probe from retractor assembly again.

Installation

6. Using the equation $(L + D/2 + 0.73")$ from Figure 2.8, calculate the insertion depth and mark on the probe while measuring from the end of the probe.
7. Ensure there is enough clearance to remove the meter from the retractor. See the Retractor Clearance table in Fig 2.8 for the model code of your meter.

Fig. 2.11: Determining and Marking Insertion Depth

RETRACTOR CLEARANCE	
CODE	"RC" DIMENSION
15R	23.5" [59.7 CM]
18R	26.5" [67.3 CM]
24R	32.5" [82.6 CM]
30R	38.5" [97.8 CM]
36R	44.5" [113.0 CM]

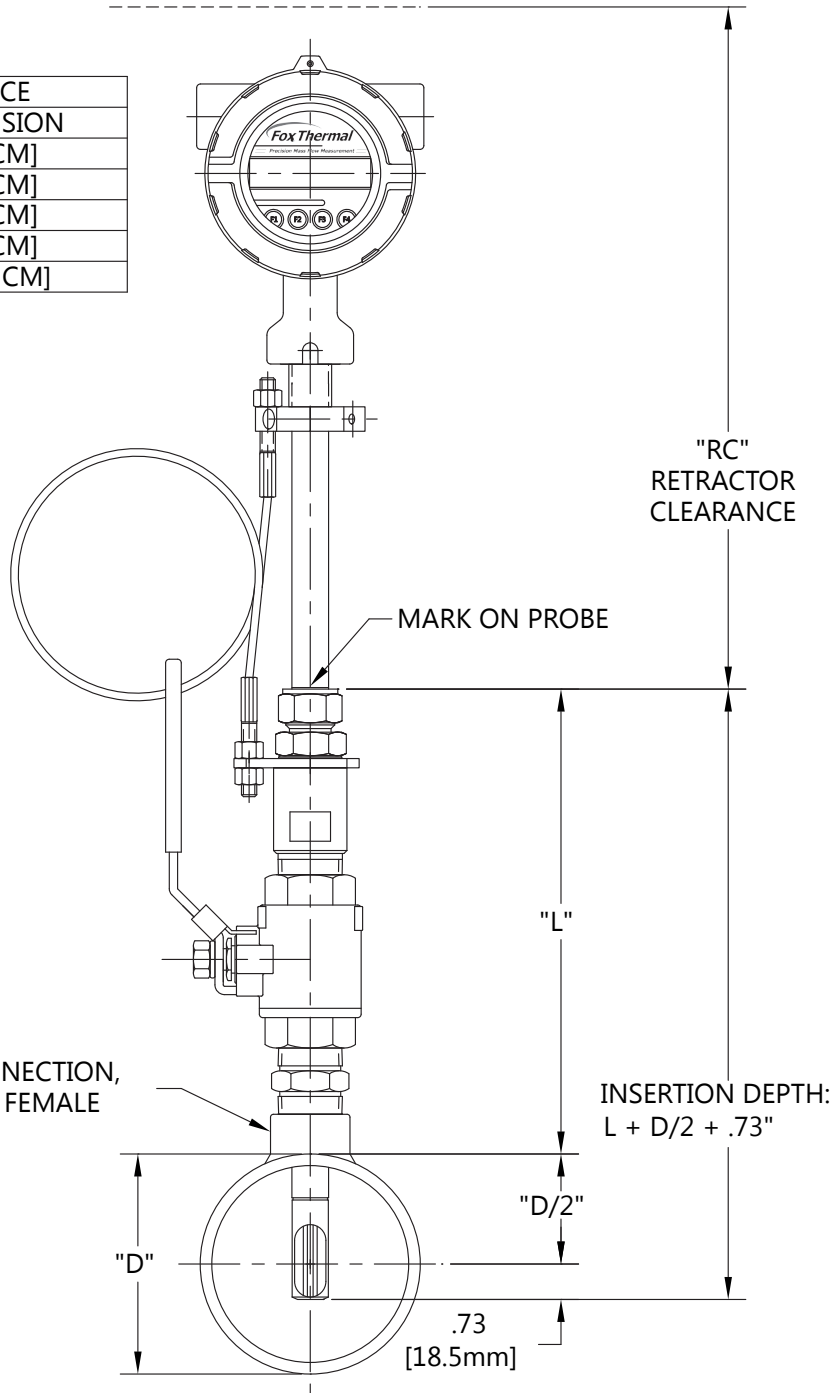

NOTE! For 1½" (38mm) pipes, insert the probe fully so that it reaches the bottom inside of the pipe, then lift up 0.2" (5mm) for proper depth setting.

Installation

8. Insert probe back into valve assembly to the depth mark and hand-tighten the compression fitting.
9. Verify that flow direction indicator is in line with pipe and in the direction of flow.

Fig. 2.12: Flow Direction and Mounting

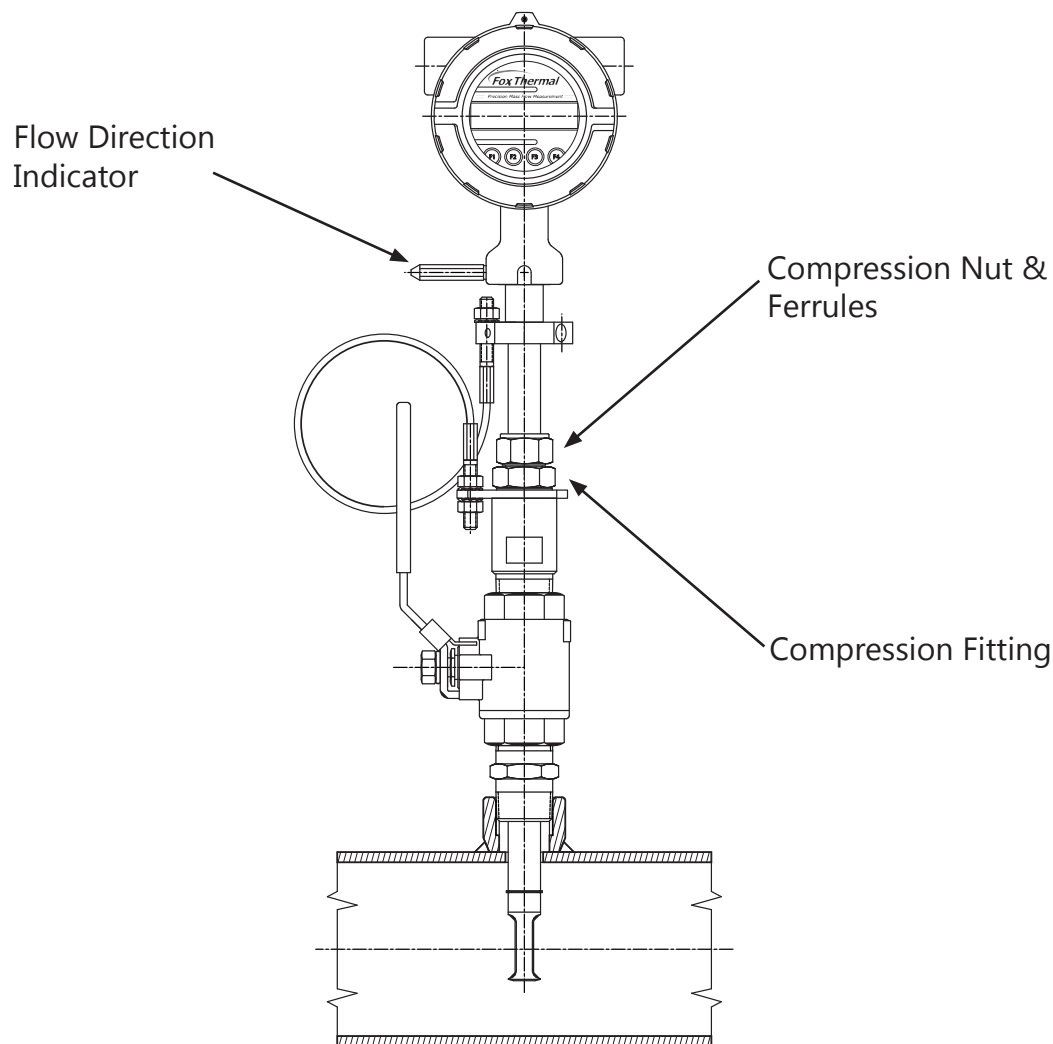

10. Fully tighten compression fitting (refer to "Fig. 2.8: Proper Tightening of the Compression Fitting Nut" on page 24).
11. Install collar clamp back on probe just below the collar spacer. Install collar so that the cable mounting hole is in line with the mounting hole on the bracket (see image in "Fig. 2.9: Retractor Assembly With and Without Probe Inserted" on page 25).



NOTE! For instructions on how to properly remove and replace the meter from a retractor, please refer to "Instructions for Removing and Inserting the Meter from a Pressurized Pipe using the Retractor" on page 90.



Wiring Instructions

To wire the FT1 connect the power and signal wires to the terminal blocks according to the label and instructions on the following pages.

Fig. 3.1: FT1 Wiring Access

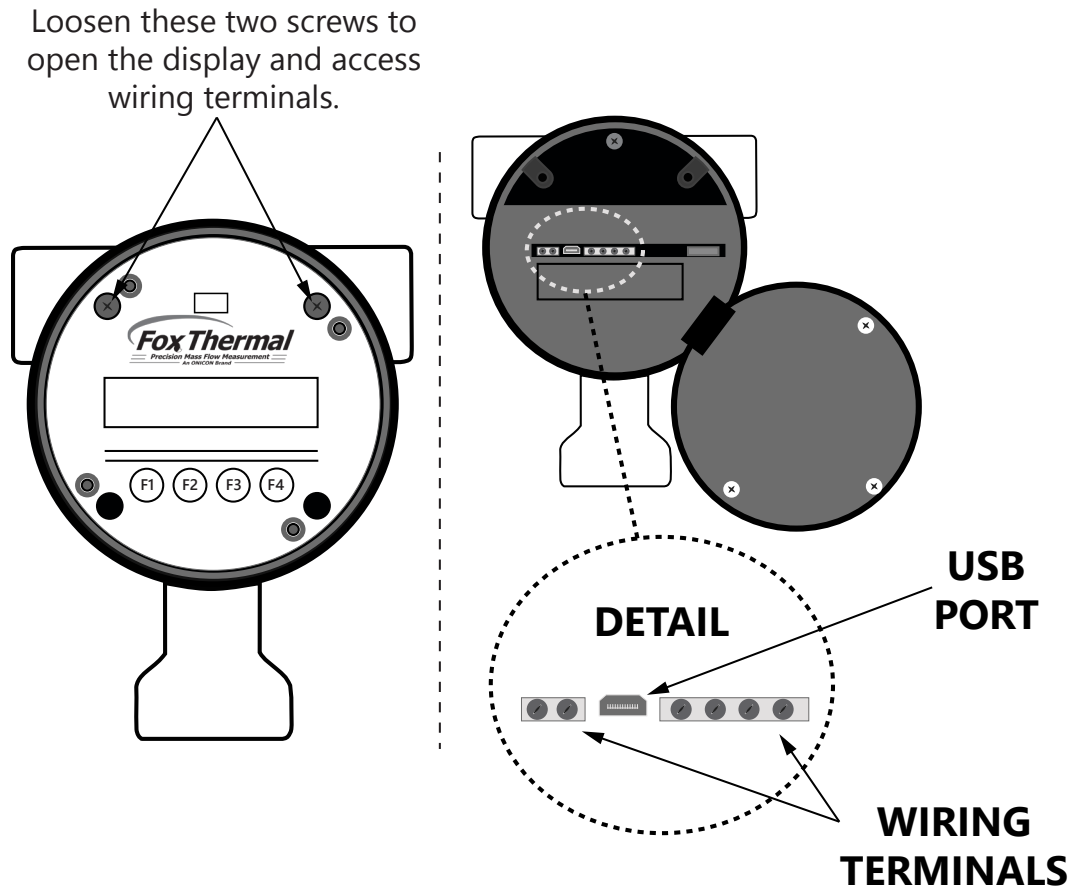

To wire the FT1, unscrew and remove the enclosure cap. If the meter has the display option, loosen the two captive screws on the display assembly and rotate it open to access the wiring terminals. Connect the power and signal wires to the terminal blocks according to the label and instructions on the following pages.

Cut all wires as short as allowable for a minimum service loop. Obtain the correct length for the FT1 wires using one of these methods:

- Trim the wires to extend 2 inches out of the enclosure after the conduit and wires are routed to the FT1.
- Trim the wires to extend 5 inches from the end of the conduit before attaching them to the FT1.



Wiring Precautions - WARNING!

- Do not open the enclosure when energized or an explosive atmosphere is present.
- Connect earth ground to a chassis ground screw on the inside or outside of FT1 enclosure to reduce the potential of an electrostatic charging hazard.
- All plumbing and electrical installations of flow meters must be in compliance with local codes, the end user's best engineering practices, and manufacturer's recommendations.
- Do not install the FT1 enclosure near an igniter, igniter-controller or switching equipment to eliminate the possibility of noise interference.
- Do not install an external power supply in a cabinet containing an igniter controller or switching equipment.
- This flow meter contains components that can be damaged by static electricity. You must discharge yourself by touching a grounded steel pipe or other grounded metal prior to working inside this flow meter.
- Close any unused conduit openings with suitable certified plugs

Power Wiring

For wiring the 12 to 28VDC power, use stranded copper wire, no larger than 16-gauge. Twisted pair 16 to 20 gauge shielded cable is recommended. Supply connection wiring must be rated for at least 90°C.

Grounding

The enclosure must be properly grounded with a quality earth ground. 16 gauge, stranded wire is recommended.

Signal Wiring

For signal and serial communication wiring, the recommended wire gauge is 18 to 22 AWG. Always use twisted pair shielded cable.



Wiring: Input Power

Power Input Requirements: 12 to 28VDC Supply

External DC power supply must provide 12 to 28VDC (10 to 30VDC full input power range) at 6 Watts minimum.

(With 12VDC power, the FT1 can use up to 500mA. With 24VDC power, the FT1 can use up to 250mA.)

A 20 Watt or greater power supply is recommended to ensure it can provide enough current under all temperature, ventilation and power on conditions.

The enclosure must be properly grounded with a quality earth ground. Sixteen (16) gauge, stranded wire, is recommended for earth ground.

Fig. 3.2: Connections for 12 to 28VDC Supply

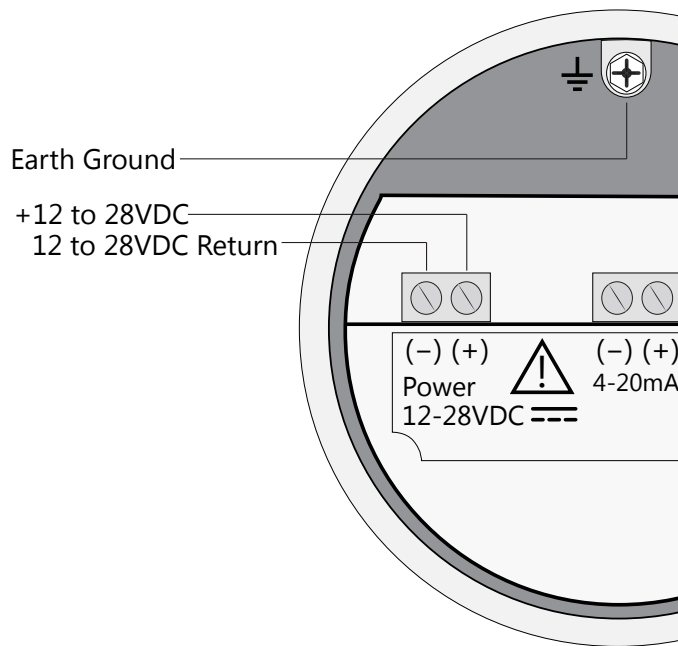

CAUTION!

- Supply connection wiring must be rated for at least 90°C.



Wiring: Signal Wiring

4-20mA Output Wiring: Customer-Supplied Power Source

Bring the 4-20mA wiring in through either conduit hub. Connect 4-20mA wiring as shown in the diagram below.

Fig. 3.3: 4-20mA Output Wiring for Customer-Supplied Power Source

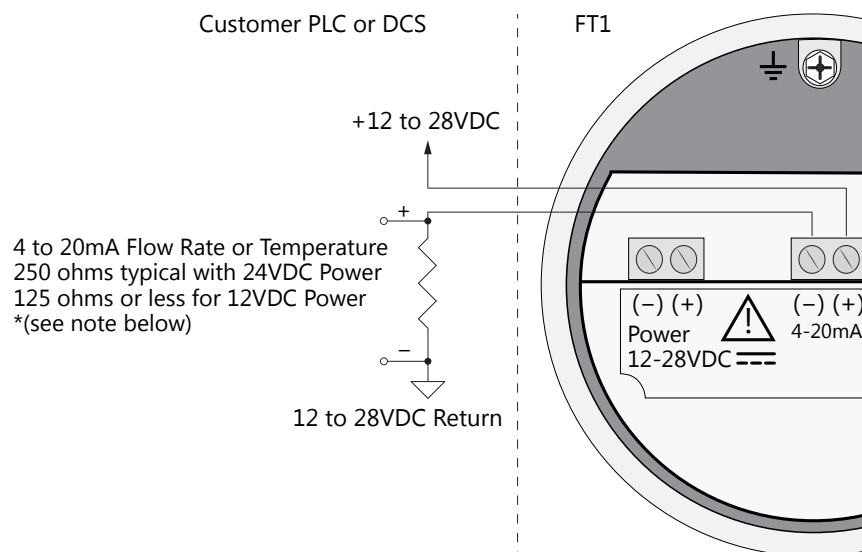

NOTE!

- When using a 12 volt power supply, the load resistor on the 4-20mA output must be 125 ohms or less to operate properly.
- When using 24 volt power, the load resistor is typically 250 ohms. A 250 ohm resistor in the 4-20mA circuit will result in a 1 to 5 volt signal to the PLC or DCS.
- When using a 24 volt power supply, the load resistor on the 4-20mA output must be 600 ohms or less.
- Some PLC and DCS equipment have built in load resistors, please refer to the technical manuals of such equipment.

Wiring: Signal Wiring



4-20mA Output Wiring: Loop Power Provided by FT1

Bring the 4-20mA wiring in through either conduit hub. Connect the 4-20mA as shown in the diagram below.

Fig. 3.4: 4-20mA Output Wiring for Loop Power Provided by FT1

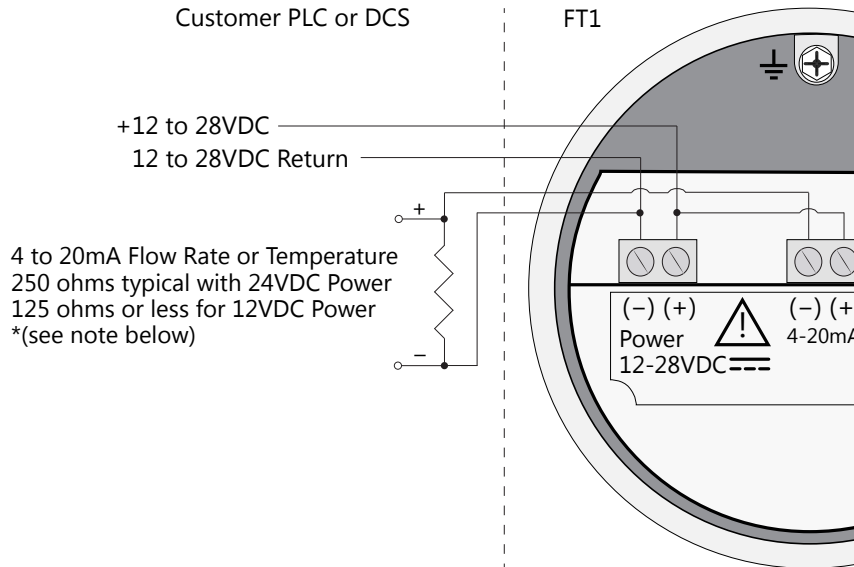

WIRING



NOTE!

- When using a 12 volt power supply, the load resistor on the 4-20mA output must be 125 ohms or less to operate properly.
- When using 24 volt power, the load resistor is typically 250 ohms. A 250 ohm resistor in the 4-20mA circuit will result in a 1 to 5 volt signal to the PLC or DCS.
- When using a 24 volt power supply, the load resistor on the 4-20mA output must be 600 ohms or less.
- Some PLC and DCS equipment have built in load resistors, please refer to the technical manuals of such equipment.



Wiring: Pulse/Alarm Wiring

Pulse/Alarm Output Wiring: Customer Supplied Power Source (Recommended)

Bring pulse/alarm wiring in through either conduit hub. Connect as shown in the diagram below. The pulse/alarm output is an open collector circuit capable of sinking a maximum of 20mA of current. Pulse or alarm selection is programmed using the display or FT1 View™. Only one option, pulse or alarm, can be active at a time.

Fig. 3.5: Pulse/Alarm Output Isolated (Recommended)

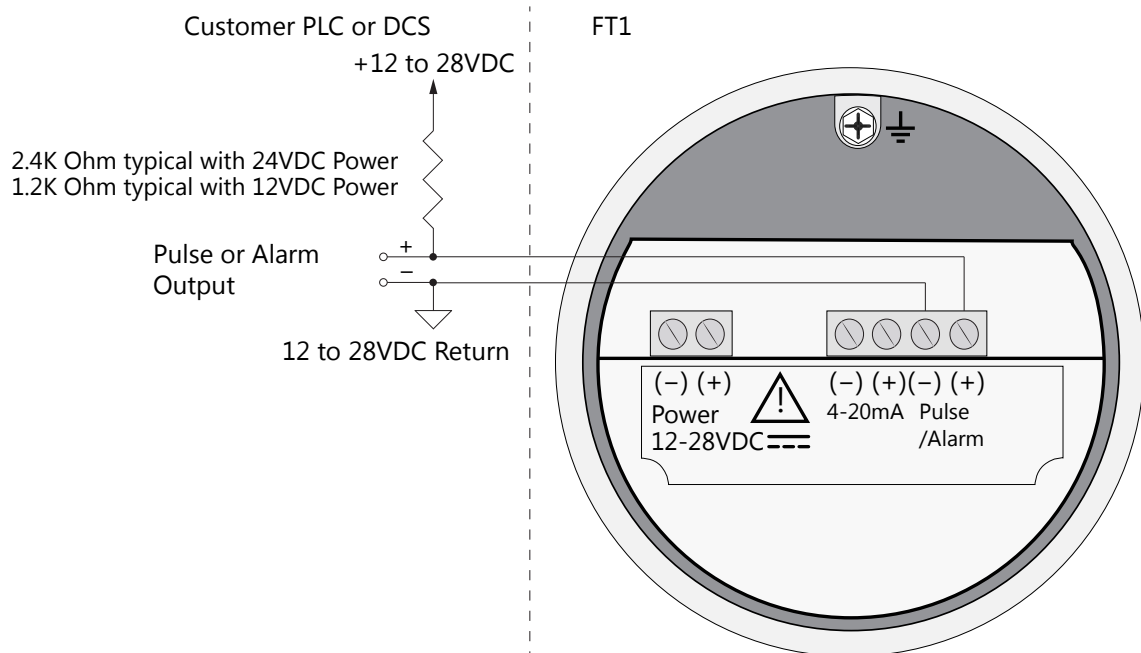

NOTE!

- The FT1 Pulse/Alarm output is typically used to drive digital circuitry or solid-state relays. The output of a solid state relay may, in turn, operate loads such as electromechanical relays or alarm indicators.
- The maximum load current of the Pulse/Alarm output is 20mA. Choose a load resistance that provides approximately 10-20mA with the power supply operating voltage.
- When the output is configured for Alarm and an alarm is not active, the output will be on (0 volts output). When an alarm is active, the output will be off (12 to 28 volts output).
- In order to use the Pulse/Alarm feature on the Model FT1, this feature must be chosen when the meter is ordered from the factory. Pulse output not available with meters ordered with Modbus RTU (RS485) and BACnet MS/TP (RS485).

Wiring: Pulse/Alarm Wiring



Pulse/Alarm Output Wiring: Power Provided by FT1

Bring pulse/alarm wiring in through either conduit hub. Connect as shown in the diagram below. The pulse/alarm output is an open collector circuit capable of sinking a maximum of 20mA of current. Pulse or alarm selection is programmed using the display or FT1 View™. Only one option, pulse or alarm, can be active at a time.

Fig. 3.6: Pulse/Alarm Output Power Provided by FT1

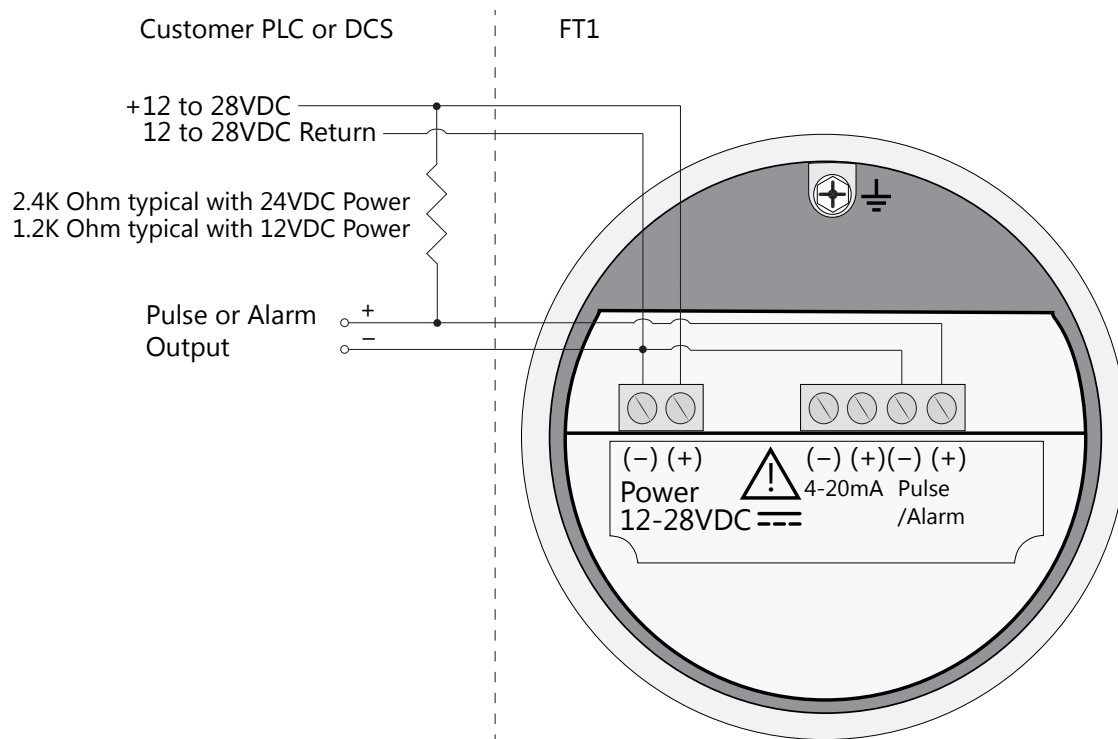

WIRING



NOTE!

- The FT1 Pulse/Alarm output is typically used to drive digital circuitry or solid-state relays. The output of a solid state relay may, in turn, operate loads such as electromechanical relays or alarm indicators.
- The maximum load current of the Pulse/Alarm output is 20mA. Choose a load resistance that provides approximately 10-20mA with the power supply operating voltage.
- When the output is configured for Alarm and an alarm is not active, the output will be on (0 volts output). When an alarm is active, the output will be off (12 to 28 volts output).
- In order to use the Pulse/Alarm feature on the Model FT1, this feature must be chosen when the meter is ordered from the factory. Pulse output not available with meters ordered with Modbus RTU (RS485) and BACnet MS/TP (RS485).



Wiring: RS485 Modbus RTU or BACnet MS/TP

RS485 Wiring for Modbus RTU or BACnet MS/TP

Wiring connections are made as shown in the diagram below for Modbus communication.

Termination Resistor

Connect a termination resistor across the receive/transmit signals of the last device on the communication line. To connect the 121 ohm termination resistor on the FT1, set jumper W1 to the Terminated position, see Fig. 3.6.

Disconnect the termination resistor on all other external RS485 devices. The termination resistor of the FT1 is disconnected by setting jumper W1 to the Open position.

Fig. 3.7: RS485 Wiring

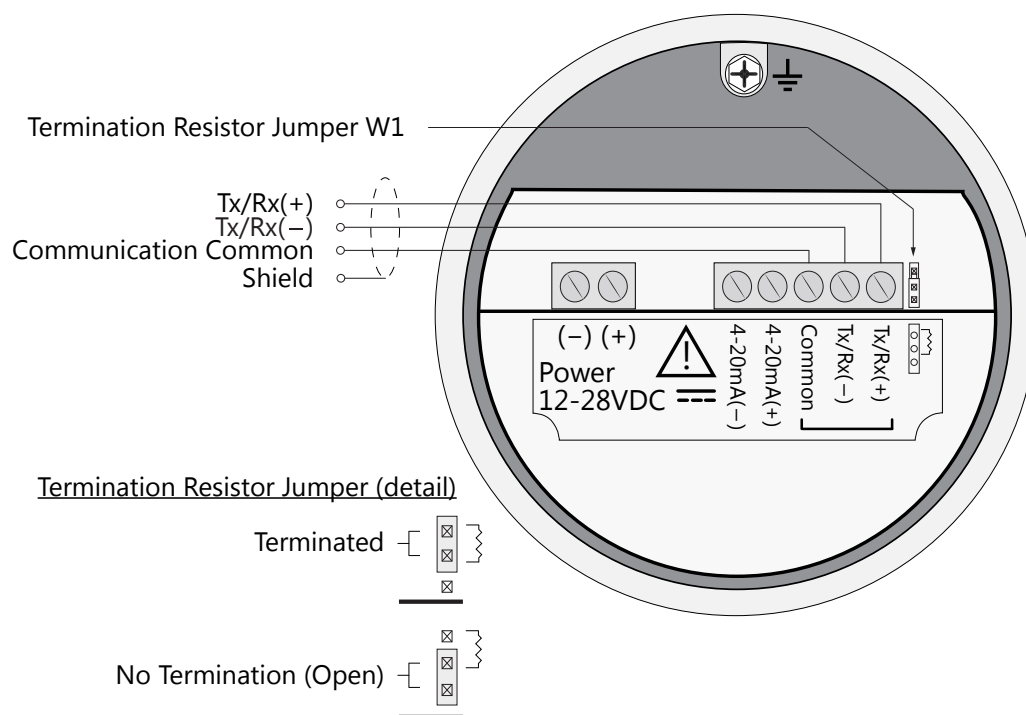

NOTE!

- In order to use the RS485 feature on the Model FT1, this feature must be chosen when the meter is ordered from the factory. Modbus RTU and BACnet MS/TP are not available with meters ordered with the Pulse/Alarm option.
- W1 jumper will either be in the open or terminated position. It should be in the terminated position on the last meter in the series.

Wiring: HART

**HART Wiring**

The HART connections are made as shown in the diagram below.



NOTE! Meters ordered with HART will be configured for flow as default. If the customer changes the 4-20mA output to temperature, HART should report temperature.

HART 4-20mA Output Wiring: Customer-Supplied Power Source

The 4-20mA current loop and HART modem connections are made as shown in the diagram below.

Fig. 3.8: HART Wiring, Customer-Supplied Power Source

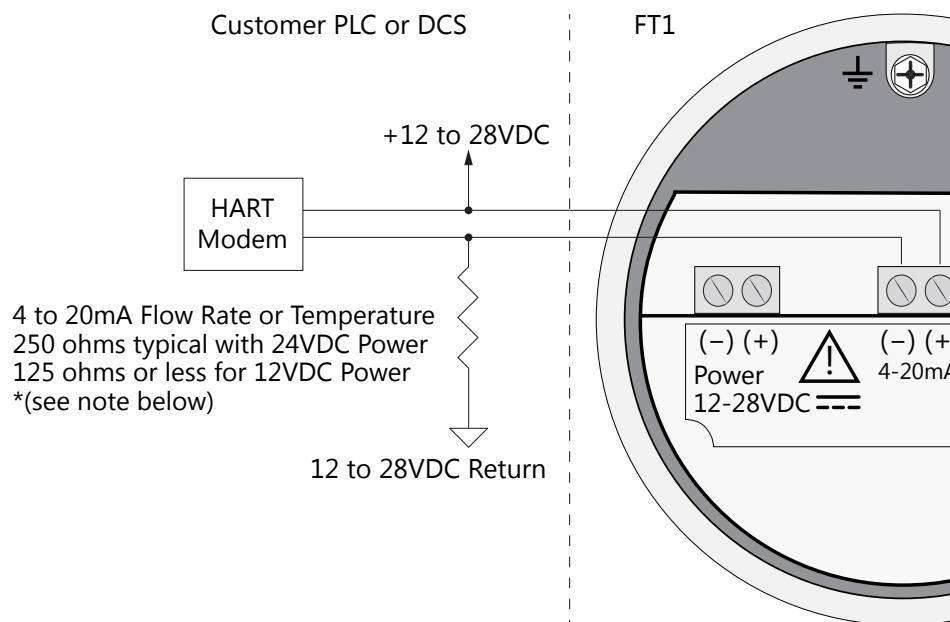
**Fig. 3.8, 3.9, and 3.10, NOTE!**

- When using a 12 volt power supply, the load resistor on the 4-20mA output must be 125 ohms or less to operate properly.
- When using 24 volt power, the load resistor is typically 250 ohms. A 250 ohm resistor in the 4-20mA circuit will result in a 1 to 5 volt signal to the PLC or DCS.
- When using a 24 volt power supply, the load resistor on the 4-20mA output must be 600 ohms or less.
- Some PLC and DCS equipment have built in load resistors, please refer to the PLC/DCS technical manual.



HART 4-20mA Output Wiring: Handheld Communicator

The 4-20mA current loop connections are made as shown in the diagram below.

A hand-held HART communicator can be connected to test points TP12 (+) and TP13 (-) with clip leads or to the 4-20mA terminal block.

Fig. 3.9: HART 4-20mA Output Wiring, Handheld Communicator

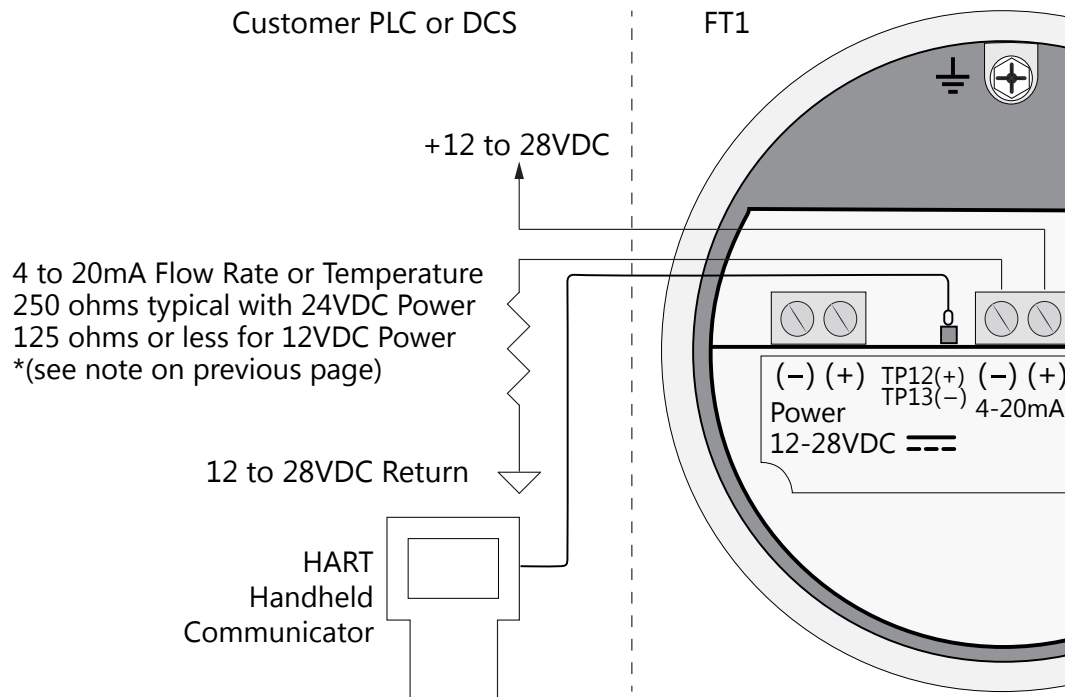



Wiring: HART

HART 4-20mA Output Wiring: Loop Power Provided by FT1

The 4-20mA current loop and HART modem connections are made as shown in the diagram below.

Fig. 3.10: HART 4-20mA Output Wiring, Loop Power Provided by FT1

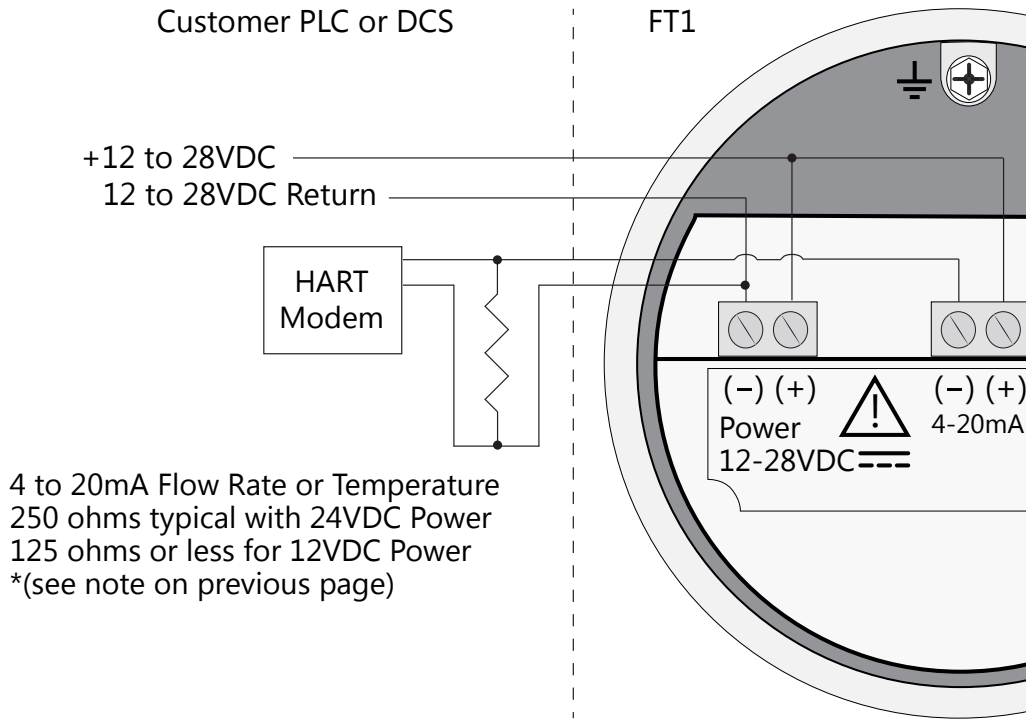

Operation: Start Up

Start Up Sequence

The program automatically enters the Run/Measure mode after power up. The screen will show the software version of the FT1 during power up.

USB Interface

The USB interface is a standard feature which allows communication with a PC to monitor readings and configure settings. FT1 View™, is a free application program from Fox Thermal that connects to the USB interface and allows data monitoring, configuration setting, data logging to Excel, and an option to save and recall FT1 configuration data.

FT1 Display and Configuration Panel

The FT1 has a 2 line x 16 character display with 4 mechanical buttons. The meter can be programmed by using the display and configuration panel. The configuration panel can be accessed by removing the FT1 cap. Be sure to replace the cap after you are done configuring the FT1.

Fig. 4.1: FT1 Display and Configuration Panel

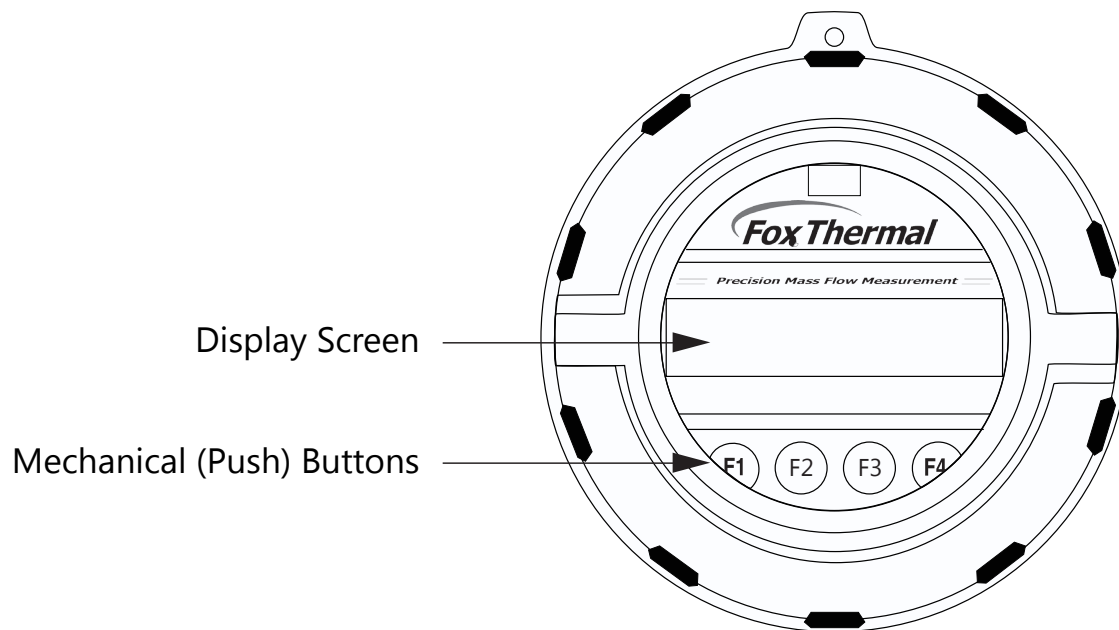

Operation: Display Screens

Measurement Mode Display Screens

In the measurement mode, there are four different display screens (display 1, 2, 3 and a prompt screen to enter the programming mode). Two display screens are user programmable (refer to Display Setup p. 48). Scrolling through the display is accomplished by pressing the F1 or F2 key to view the next or previous screen.

Pressing the F1 and F2 keys at the same time enters the Engineering Menu screens. F1 and F2 keys increment and decrement through screens. Key F4 is used to exit to Display screen #1. See Fig 1.8 on p. 13 to view Engineering screens and their descriptions.

Pressing the F3 and F4 keys at the same time brings up the Reset Total screen (see p. 58) prompt.

Fig. 4.2: FT1 Measurement Mode Display Screen Navigation

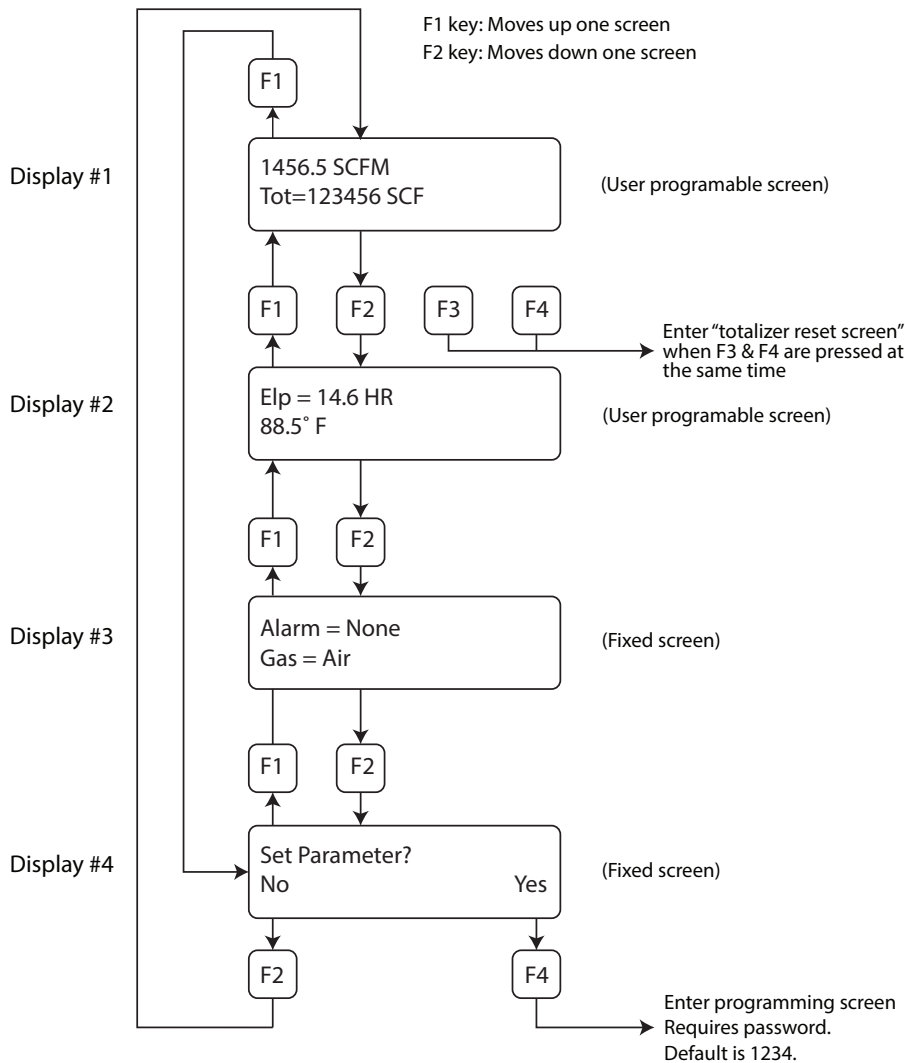

Operation: Programming

Programming: Data Entry using the Display and Configuration Panel

There are 2 basic types of menu entries: one for **changing value or string** and one for **selecting from a selection list**.

To Change a Value or String :

VALUE = 0.91234	OK
CHG	

F1	F2	F3	F4
----	----	----	----

Press **CHG (F1)** key to change the value, **OK (F4)** to accept the value.

VALUE = 0.91234	OK		
UP	DN	NXT	

F1	F2	F3	F4
----	----	----	----

Press the **UP (F1)** or **DN (F2)** key to select a new digit or character, the cursor points to the selected digit. Press **NXT (F3)** to select the next digit and **OK (F4)** to accept the entry.

To Select from a List:

FLO UNT = SCFM	OK
NXT	

F1	F2	F3	F4
----	----	----	----

Press **NXT (F1)** key repeatedly until the correct selection is made and **OK (F4)** key to accept the entry.

Entering the Programming Mode

To enter the programming mode and access the Main Menu, press the **F1** or **F2** key in the normal running mode until the following screen is shown:

SET PARAMETERS ?	
No	Yes

F1	F2	F3	F4
----	----	----	----

Press **YES (F4)** and the following screen will prompt user to enter password:

PASWD: _	OK		
UP	DN	NXT	

F1	F2	F3	F4
----	----	----	----

Operation: Programming

Enter the correct password, then follow the instructions for changing a value as specified on page p. 42. The default Level 1 password is "1234". If the wrong password is entered, the message "Wrong Password" will display and then return to the programming entry screen.

Main Menu

If the password is accepted, the Main Menu screen will be shown:

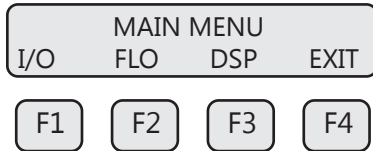

This is the Main Menu screen for the programming mode. Press **EXIT (F4)** repeatedly until "Normal Mode" is seen briefly to exit the programming mode.

Analog 4-20mA Output

The following menu allows the scaling of the analog 4-20mA output. From the Main Menu, press **I/O (F1)** to move to the 4-20mA output selection. In this screen press **420 (F3)** (screen appearance may vary according to options).

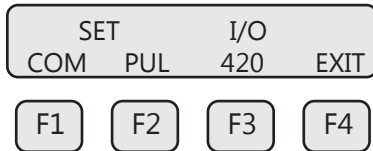

The 4-20mA output is programmable for flow or temperature:



Selections for the 4-20mA output are:

Flow
Temp

Select **NXT (F1)** to select Flow or Temperature and then press **OK (F4)**.

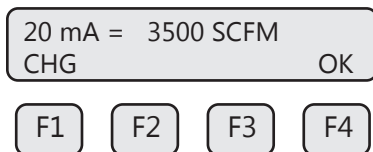

Enter the value for the 20mA and press **OK (F4)** key to accept the setting. Then the following

Operation: Programming

screen will display:

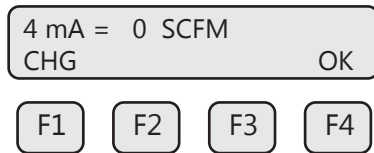

Enter the value for the 4mA and press **OK (F4)**.



NOTE! When the flow rate exceeds the programmed value for the 20mA set point, the analog output will stay at 20mA and an alarm code will be generated.



NOTE! 4mA is normally set to 0.

After setting the 4mA output value, choose the mA fault value:

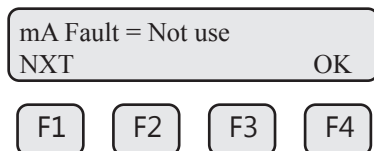

This menu allows the user to select an alarm fault level on the 4-20mA output. The alarm is activated when a serious issue is detected preventing the calculation of the correct flow rate. The 3.6mA and 21mA alarm outputs are related to the NAMUR NE 43 alarm feature.

The options are:

- mA Fault=3.6 mA (Force the 4-20mA signal to 3.6mA on alarm)
- mA Fault=21 mA (Force the 4-20mA signal to 21mA on alarm)
- mA Fault=Not use (4-20mA signal alarm fault not used)

The following events will set the output to 3.6mA or 21mA if the alarm level is selected:

- Sensor resistance above high limit
- Bridge Shutdown

Fig. 4.3: Range of 4-20mA Output and NAMUR Alarm

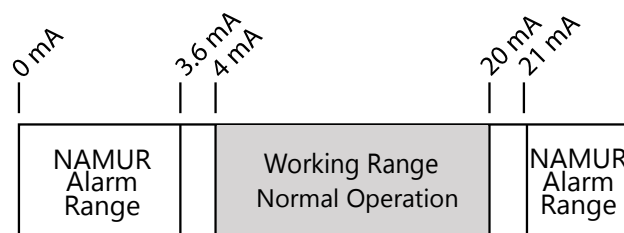

Press **(F4)** repeatedly until "Normal Mode" is seen briefly to exit the programming mode.

Operation: Programming



NOTE! When the flow rate exceeds the programmed value for the 20mA set point, the analog output will stay at 20mA and an alarm code will be generated.

Pulse/alarm Output

If the Pulse/alarm feature was purchased as the second output for the Model FT1, it can be accessed from the Main Menu, press **I/O (F1)** (screen appearance may vary).

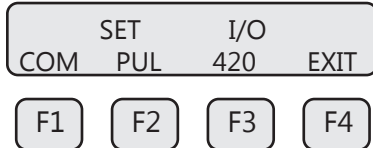

Press **PUL (F2)** to select the pulse output.
The following screen will show:

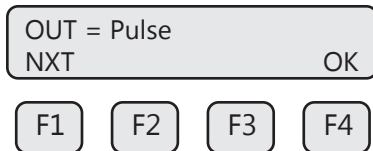

Press **NEXT (F1)** to cycle through output options until you have the selection for "OUT=Pulse" and press **OK (F4)**.

The pulse output can be configured in one of three ways:

1. Specifying how many pulses per unit, P/U (i.e., 10 pulses per SCF)
2. Specifying how many flow units total per pulse, U/P (i.e., 0.1 SCF per pulse)
3. Specifying a maximum frequency to a defined maximum value of flow rate

All of these approaches are equivalent.

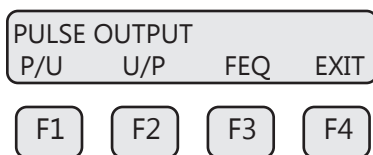

Use **P/U (F1)** to enter pulse per unit, **U/P (F2)** for unit per pulse or **FEQ (F3)** to enter the flow and maximum frequency to scale the pulse/alarm output.



NOTE! When data is entered with any of the three described methods, the other values will be re-calculated according to the settings.

Operation: Programming

Entering data in Pulse per Unit:

From the Pulse/alarm Output Menu above, press **P/U (F1)** and the following screen will show:

PLS/UNT = 2	OK
CHG	

F1 F2 F3 F4

Press **CHG (F1)** to change the setting and then **OK (F4)** to accept entry.

The value entered is in pulse per selected flow unit total (i.e., 2 pulses per SCF).

Entering data in Unit per Pulse:

From the Pulse/alarm Output Menu above, press **U/P (F2)** and the following screen will show:

UNT/PLS = 0.5	OK
CHG	

F1 F2 F3 F4

Press **CHG (F1)** to change the setting and then **OK (F4)** to accept entry.

The value entered is in unit per pulse (i.e. 0.5 flow unit total per pulse)

Entering data with flow and maximum frequency:

From the Pulse/alarm Output Menu above, press **FEQ (F3)** and the following screen will show:

MaxFreq=100 Hz	OK
CHG	

F1 F2 F3 F4

Enter the maximum pulse rate (frequency) and press **OK (F4)**.



CAUTION! Maximum pulse rate (frequency) cannot exceed 100 Hz.

The next screen will show:

MaxFlo=5000 SCFM	OK
CHG	

F1 F2 F3 F4



NOTE! If the flow rate exceeds the maximum pulse rate (frequency), the output will stay at 100 Hz and the FT1 will issue an alarm code.

Operation: Programming

Alarm Output

If the Pulse/alarm feature was purchased as the second output for the Model FT1, press **I/O (F1)** key from the Main Menu screen.

The screen will show:

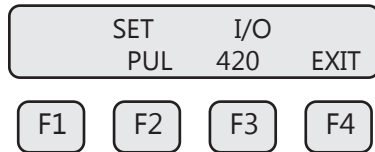

Then press **PUL (F2)** and the screen may show:



Then press **NXT (F1)** to select the correct alarm and press **OK (F4)**.

Selections are:

Not used

Pulse

HiFloAlm = High Flow Alarm

LoFloAlm = Low Flow Alarm

HiTempAlm = High Temperature Alarm

LoTempAlm = Low Temperature Alarm

SystemAlm = System Alarm

When the output is set to Alarm and there is no alarm condition, the output will be on (0 volts). When an alarm is active, the output is turned off (12 to 24 volts). The following conditions generate a System Alarm: Sensor failure or flow meter electronics failure.

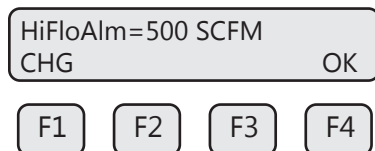

Enter the value for the limit by pressing **CHG (F1)** and then **OK (F4)**.



NOTE! There is only one output to operate as a pulse output or an alarm output. Both cannot operate at the same time.

Operation: Programming

Serial Communication Settings

If the RS485 Communication feature was purchased as the second output for the Model FT1, the Serial communication settings can be programmed by pressing **I/O (F1)** key from the Main Menu. The screen will show:



Press **COM (F1)** to select Serial communication. The screen may show:

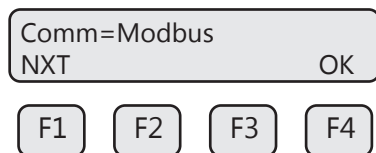

Options for serial communication are:

- None
- Modbus
- BACNET
- HART



NOTE! Any selection other than "None" requires the communication option for the selected communication type. If enabling a communication option, see the Communications Protocols section of this manual.

Display Setup

There are four display screens that you can cycle through in normal operating mode (see Figure 4.2 on p. 41). Two of the four display screens are fixed and cannot be changed (displays #3 & 4). The other two screens are programmable to show the information that you prefer and is discussed in this section.

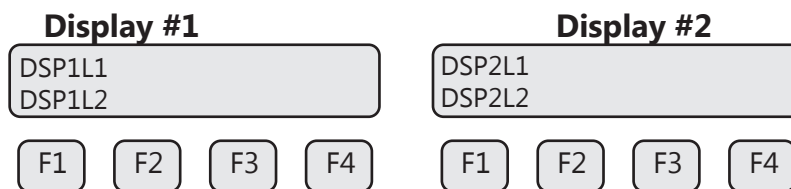

Selections are:

- | | |
|--------|-------------------|
| DSP1L1 | Display 1, Line 1 |
| DSP1L2 | Display 1, Line 2 |
| DSP2L1 | Display 2, Line 1 |
| DSP2L2 | Display 2, Line 2 |

Operation: Programming

To Program Display Screens #1 & 2:

From the Main Menu press **DSP (F3)** to select the Display Menu:

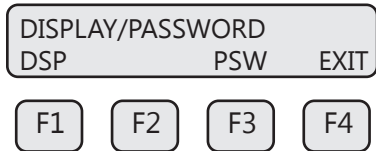

Press **DSP (F1)** key. The display will show:

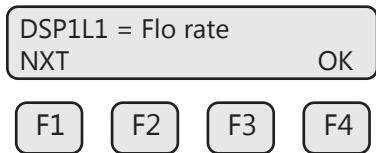

These are the selections for the display #1 line #1.

Selections are:

- | | |
|----------|----------------------|
| Flo rate | Flow rate |
| Total | Total mass or volume |
| Elps | Elapsed time |
| Temp | Temperature |
| Alarm | Error codes |

When the selection is correct, press **OK (F4)** to accept. The display will then go through the same process for all 4 lines of the 2 programmable displays (DSP1L1, DSP1L2, DSP2L1 and DSP2L2).

After the last line of display 2 is accepted, the display will show the following menu:

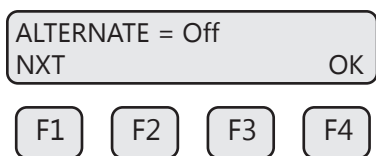

This menu allows you to alternate between menu display 1 and 2 every few seconds.

Selections are: On or Off

Press **OK (F4)** to accept selection. Press **EXIT (F4)** repeatedly until "Normal Mode" is seen briefly to exit the programming mode.

Operation: Programming

Password

There are two user level passwords, only **Level 1** is programmable and gives access to all the normal settings. The second password is used to allow access to calibration factors and should normally never be changed unless advised by the Fox Thermal service department, or to set a new password in the event that the user forgets the **Level 1** password.

Default **Level 1** password is "1234", and **Level 2** password is "9111".

The **Level 1** programmable password can be disabled by setting it to "0".

From the Main Menu press **DSP (F3)** to select the Display Menu:

To Program the Password:

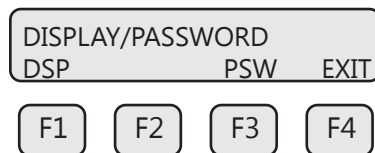

Press **PSW (F3)** key to select password.

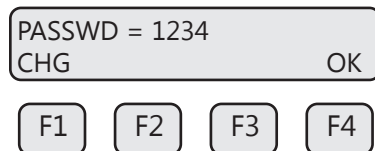

This screen displays the current **Level 1** password.
Press **CHG (F1)** key to change the password and enter new value.

Press **OK (F4)** to accept new data and exit programming by pressing **EXIT (F4)** key repeatedly until out of the programming mode.

Units Settings Menu

This menu is used to set the units for flow, temperature, and pressure.
Reference temperature and reference pressure settings can also be accessed.

These values are set at Fox Thermal using information supplied by the customer. These values can be changed to match a new application. Units setting is accessed from the Main Menu.



NOTE!

Password can be number or letter characters up to 4 digits.

Operation: Programming

To access the Unit Settings Menu:

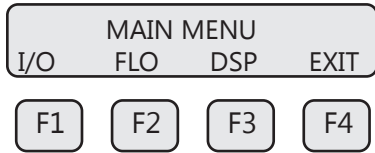

Press **FLO (F2)**:

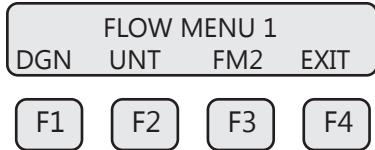

Press **UNT (F2)** for Unit selection.

The screen will show:

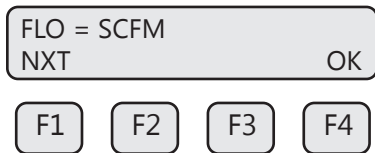

Press **NXT (F1)** to change selection and **OK (F4)** to accept.



NOTE! The totalizer (total flow measured) will roll over when reaching a certain value. The maximum value is dependent on the flow units selected (see Totalizer Rollover p. 58).



WARNING! The FT1 re-calculates area, 4 and 20mA values, maximum flow for the pulse output and zero flow cutoff when changing flow units. The totalizer must be reset immediately after changing units.

Selections for flow units are:

SCFM	KG/S	MMSCFD (MMCFD)	MT/H
SCFH	LBS/H	LBS/D	NM3/D
NM3/H	LBS/M	SLPM	MMSCFM (MMCFM)
NM3/M	LBS/S	NLPS	SCFD
KG/H	NLPH	MSCFD (MCFD)	MCFD (MSCFD)
KG/M	NLPM	SM3/H	SM3/M
			SM3/D

Operation: Programming

After pressing **OK (F4)** to accept the Flow unit the display will prompt for the temperature unit setting:



Press **NXT (F1)** to change selection and **OK (F4)** to accept.

Selections for Temperature units are:

Deg C

Deg F

After pressing **OK (F4)** to accept the temperature unit setting, the display will prompt for temperature reference in selected unit.

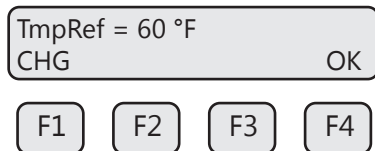

Press **CHG (F1)** to change the reference and **OK (F4)** to accept.

After pressing **OK (F4)** to accept the reference temperature, the display will prompt for the reference pressure unit selection:

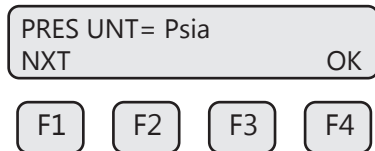

Press **NXT (F1)** to select next entry and **OK (F4)** to accept.

Selections are:

mmHG	Millimeters of mercury (absolute)
Psia	Pounds per square inch absolute
bara	Bar absolute

After the pressure unit selection is made, the display will show a menu to enter the reference pressure:

Operation: Programming

PresRef= 14.7			
CHG			OK
F1	F2	F3	F4

Press **CHG (F1)** to change it and **OK (F4)** to accept.

After the reference pressure is accepted, the FT1 will recalculate and display gas density at user's reference temperature and pressure:

DNS = 1.2930 KG/m3			
			OK
F1	F2	F3	F4

The gas density is for information only. Press **OK (F4)** to continue.

Flow Parameters

This is the menu used to set various flow parameter values. They are:
Flow cutoff, pipe diameter, filter, high and low alarm for flow and temperature.

MAIN MENU			
I/O	FLO	DSP	EXIT
F1	F2	F3	F4

The menu is accessed from the Main Menu by pressing **FLO (F2)**:

FLOW MENU 1			
DGN	UNT	FM2	EXIT
F1	F2	F3	F4

Then press **FM2 (F3)**:

FLOW MENU 2			
GAS	SPC	PRM	EXIT
F1	F2	F3	F4



NOTE! The **SPC** function key will only appear and be accessible from a **Level 2** password.

Operation: Programming

Flow Cutoff

Then press PRM (F3). The first parameter is Flow Cutoff:

CUTOFF = 2.0 SCFM	
CHG	OK

F1 F2 F3 F4

Enter the value for the low flow cutoff and then press **OK (F4)**. When the flow rate falls below the zero flow cutoff, the flow meter will display a flow value of zero.

Pipe Inside Diameter (ID)

To set the Pipe Inside Diameter:

Pipe_id = 3.068 In	
CHG	OK

F1 F2 F3 F4

Enter the pipe ID in inches or **millimeters** and then press **OK (F4)**.

Use millimeters for metric flow unit selections and inches for English flow unit selections. If the pipe/duct is a square or rectangle, the hydraulic diameter (equivalent value for a round pipe) must be entered for the pipe ID.

Filter Value

The Filter Value is entered in seconds. The allowable time constant range is 0.8 to 10 seconds. The filter time interval is proportional to the dampening.

Enter the filter value and then press **OK (F4)**.

FILTER = 0.8 sec	
CHG	OK

F1 F2 F3 F4

High Flow Rate Alarm

To set the parameters for a High Flow Rate Alarm:

HiFloAlm = 1234 SCFM	
CHG	OK

F1 F2 F3 F4

Operation: Programming

This is the upper flow limit alarm value that can be associated with the alarm output. An alarm code is generated when the flow value exceeds this limit. If no checking is needed, this value should be set to zero.

Press **OK (F4)** to accept the value.

Low Flow Rate Alarm

To set the parameters for a Low Flow Rate Alarm:

LoFloAlm = 100 SCFM	OK		
CHG			
F1	F2	F3	F4

This is the lower flow limit alarm value that can be associated with the alarm output. An alarm code is generated when the flow value is below this limit. If no checking is needed, this value should be set to zero.

Press **OK (F4)** to accept the value.

High Temperature Alarm

To set the parameters for a High Temperature Alarm:

HiTmpAlm = 200° F	OK		
CHG			
F1	F2	F3	F4

This is the upper temperature limit alarm value that can be associated with the alarm output. An alarm code is generated when the temperature value exceeds this limit. If no checking is needed, this value should be set to zero.

Press **OK (F4)** to accept the value.

Low Temperature Alarm

To set the parameters for a Low Temperature Alarm:

LoTmpAlm = 20° F	OK		
CHG			
F1	F2	F3	F4

This is the lower temperature limit alarm value that can be associated with the alarm output. An alarm code is generated when the temperature value is below this limit. If no checking is needed, this value should be set to zero.

Operation: Programming

Press **OK (F4)** to accept the value.



NOTE! If the programming menu was entered with a **Level 2** password, then more menus will be shown concerning factory-set parameters that should not be changed.

K Factor

The K FACTOR allows the user to adjust the meter's calibration. The Fox Thermal flow meter increases the calculated flow rate by the K Factor. This results in a direct scaling of the meter's output across the entire full range.

The K Factor parameter is accessed from the "Flow Menu 2" menu by entering a **Level 2** password "9111" and pressing the **SPC** key (**F2**).

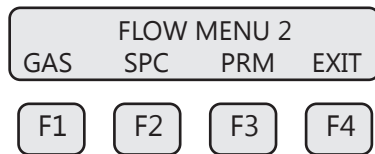

The following screen will be displayed:

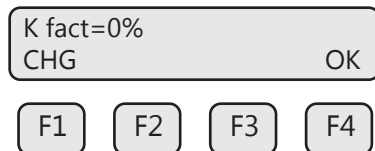

Press **CHG (F1)**. Add the correction factor and press **OK (F4)**.

For Example:

If you want the flow meter to read 5% higher, enter 5.0%.

If you want the flow meter to read 5% lower, enter -5.0%.

If an existing K Factor is present, add the additional K Factor to the existing value.

Upon pressing **OK (F4)**, an option to restore the database will follow.

Restore Database

In case of user error, the ability to restore the meter to the original factory settings can be achieved in this menu. The display will show:

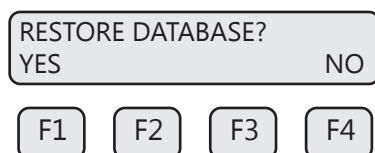

Press **YES (F1)** ONLY if you want to restore your database to the initial factory setting

Operation: Programming

that the meter was shipped with. All current user-entered settings will be overwritten. The green LP3 LED will flash at a faster pace until the recall is performed. The "RESET CRC" screen will follow "RESTORE DATABASE".

Upon pressing **OK (F4)**, an option to reset the NVRAM CRC will follow.

Reset CRC

If the NVRAM CRC check fails (Error Code 36), the programmed settings values will need to be verified and corrected before clearing the error. Call Fox Thermal Customer Service if you need assistance.

RESET CRC?	
YES	NO
F1	F2
F3	F4

Press **YES (F1) ONLY** if you want to reset the CRC and generate a new CRC value.

Non-Resettable Totalizer (NRT) Activation

Regulations in some geographic locations require that flow totalizers be non-resettable. The FT1 can conform to these regulations.



WARNING! Once the non-resettable totalizer has been activated on an FT1 flow meter, the change cannot be undone. The non-resettable totalizer is only recommended for applications that require it.

After it has been enabled, your FT1's totalizer and elapsed time counters will be non-resettable.

SET NRT?	
YES	NO
F1	F2
F3	F4

Press **YES (F1) ONLY** if you want to set the NRT.

ARE YOU SURE?	
YES	NO
F1	F2
F3	F4

If you are certain you want to activate the Non-resettable totalizer, select **YES (F1)**.

Operation: Programming

Reset Total and Elapsed Time

Enter the flow totalizer and elapsed time screen by pressing the **F3** and **F4** keys at the same time in the normal running mode (password required).

RESET TOTAL ?			
NO			YES
F1	F2	F3	F4

Press **YES (F4)** to reset total and elapsed time. Press **NO (F1)** to cancel.



NOTE! This feature is not available on non-resettable units.

Totalizer Rollover: The FT1 has an automatic roll-over function. The total flow count of the FT1 will roll over after the following values:

Most flow units:	99,999,999,999
MSCFD:	999,999,999
MMSCFM:	9,999,999
MMSCFD:	999,999

Simulation

This menu allows for simulation of flow rate and temperature. It should only be used for testing and demonstration purposes. **Make sure to return all of these simulation values to zero, before returning to the normal mode of operation.**



CAUTION! If the 4-20mA and/or the pulse/alarm outputs are connected to controllers, set the controllers to "manual". This will ensure that the simulated signals do not cause false controller action.

The menu is accessible from the main programming menu by pressing **FLO**, and **DGN (F1)**:

FLOW MENU 1			
DGN	UNT	FM2	EXIT
F1	F2	F3	F4

Pressing **DGN (F1)** will show:

DIAGNOSTIC			
SIM	ZRO	EXIT	
F1	F2	F3	F4

Operation: Programming

Pressing **SIM (F1)** will show:

Simulate Flow?			
YES	NO		
F1	F2	F3	F4

Press **YES (F1)** to continue.

FloSim = 0 SCFM			
CHG	OK		
F1	F2	F3	F4

Enter the value and then press **OK (F4)**.



NOTE! Enter zero to disable this feature.

Simulate Temp?			
YES	NO		
F1	F2	F3	F4

Press **YES (F1)** to continue.

TmpSim = 0 C			
CHG	OK		
F1	F2	F3	F4

Enter the value and then press **OK (F4)**.



NOTE! Enter zero to disable this feature.

ENABLE SIM?			
YES	NO		
F1	F2	F3	F4

Press **YES (F1)** to start the simulation mode, otherwise press **NO (F4)**. Upon pressing either key, the program will return to the Flow Menu 1 screen.



NOTE! Simulation Mode will be cleared if the power is cycled.

Calibration of the Fox Thermal Model FT1 Thermal Flow Meter

To ensure that all Fox Thermal flow meters meet specified performance parameters and provide accurate, repeatable measurements in the field, all calibrations are performed with NIST-traceable flow standards. Each meter is shipped from the factory with a Fox Thermal Calibration Certificate.

Calibration Validation

Calibration Validation allows customers to validate the accuracy and functionality of the meter in the field with a push of a button. By performing a simple test, the operator can verify that the meter is running accurately.

CAL-V™ Calibration Validation Test

Fox Thermal has developed the CAL-V™ Calibration Validation test to help our customers avoid sending the meter back for annual or biennial recalibration.

CAL-V™ ensures the repeatability, functionality of the sensor and its associated signal processing circuitry, and cleanliness of the sensor.

During the CAL-V™ calibration validation test, the microprocessor adjusts current to the sensor elements and determines the resulting electrical characteristics. Data within established tolerances confirms the meter is accurate.

Recommended Conditions for Performing CAL-V™ Test

Fox Thermal recommends the CAL-V™ test be run under flowing conditions, especially in smaller pipe sizes. If the CAL-V™ test does not produce a "PASS" result, refer to "CAL-V™ Test Results" on page 62.



NOTE! If the CAL-V™ test is performed using the Fox Thermal FT1 View™ Software, at the completion of the test, a CAL-V™ Certificate may be printed for a record of the test. This certificate will display a pass/fail result.

CAUTION!

- For applications with temperature exceeding 250°F (121°C), CAL-V™ test results may vary.
- Periodic inspection for damage and cleaning of the sensor elements is required.

Operation: CAL-V™

Performing a CAL-V™ Test

**NOTE!**

- The FT1 will stop measuring flow when performing this test.

Press **FLO (F2)** from the Main Menu. The display will show:

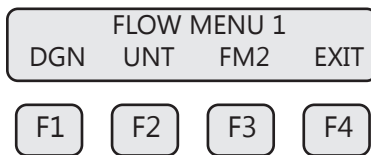

Press **DGN (F1)**. The display will show:

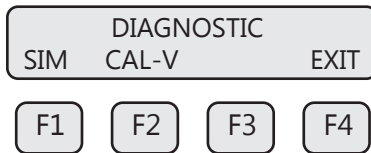

Press **CAL-V (F2)**. The display will show:

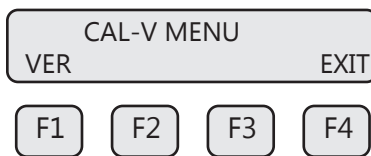

Press **VER (F1)** key to continue. Press **EXIT (F4)** to exit if you do not wish to continue.

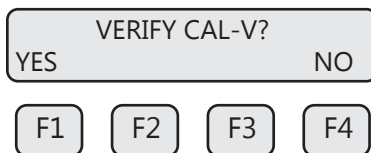

Press **YES (F1)** key to continue.

Process Stable?
YES EXIT

F1 F2 F3 F4



WARNING! If you are using a closed loop control, the system needs to be taken off-line during the test.

Press **OK (F4)** to start CAL-V™. CAL-V™ test screen will show:

Verifying CAL-V
y.yyy T=xx

F1 F2 F3 F4

This test takes about 3 minutes (200 seconds). During the test, the display will show the CAL-V™ value changing as the power to the sensor is adjusted. "T=xx" is a CAL-V™ timer indicating how much time is left to finish the test.

CAL-V™ Test Results

Upon test completion, the final CAL-V™ value will be displayed along with a Pass, Fail, or Warning message. The test result may be:

- Pass: less than ± 0.80
- Warning: between ± 0.80 to ± 1.0
- Fail: greater than ± 1.0

Recommended next steps if a "Warning" or "Fail" result is displayed:

- Run the test again under a higher flow rate if possible.
- Remove the probe from the pipe, clean the sensor, and perform the test again under a normal or high flow rate.

If a "Warning" or "Fail" result is displayed after repeating the test, please call Fox Thermal Service at (831) 384-4300 for assistance.

CAL-V=0.251
Pass OK

F1 F2 F3 F4

Press **OK (F4)** to exit the menu when the test is complete.

Operation: Gas-SelectX[®]

Accessing the Gas-SelectX[®] Gas Selection Menu Feature

This menu allows the user to select a gas or gas mix from a pre-calibrated list of gases/gas mixtures available on the Fox Thermal Model FT1 Flow meter. Gases and gas mixes available in the Gas-SelectX[®] feature include:

- Methane
- Carbon Dioxide (CO₂)
- Nitrogen
- Air
- Natural Gas*
- Argon
- Propane
- Helium
- Oxygen
- Butane
- Hydrogen
- Ethane
- 5-Gas Mix**

*Natural gas is defined as NAESB natural gas mix (94.9% Methane, 2.5% Ethane, 1.6% N₂, 0.7% CO₂, and 0.3% Propane).

**The molar percent of the gas mixes are programmable in 0.1% increments. Any five gases available in the Gas-SelectX[®] Menu may be used in any proportion totaling 100%



NOTE! For the latest gas and gas mix menu, visit the Fox Thermal Website: www.foxthermal.com

After installing your FT1 flow meter, power up the device. When the meter finishes initializing, it will begin to monitor flow in the gas and flow units assigned at the factory.

The display will show the information similar to the example below. Follow these instructions to access the Gas-SelectX[®] feature:

1162.52 SCFM
Tot=6205012.50 SCF

F1

F2

F3

F4

Operation: Gas-SelectX[®]

To enter the programming mode from the normal monitoring mode and access the Gas-SelectX[®] Menu, press the **F1** or **F2** key repeatedly until the following screen is shown:

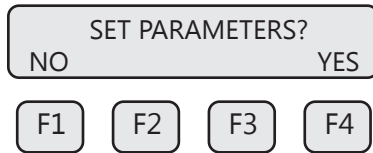

Press **YES (F4)** and the following screen will prompt the user to enter the password if it is active:

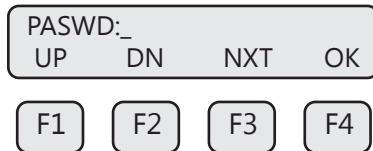

Enter the correct password and press **OK (F4)** to enter it.



NOTE! Default password is 1234.

After entering the correct password, the following is displayed:

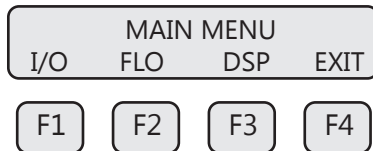

Press **FLO (F2)** to enter Flow Menu 1.

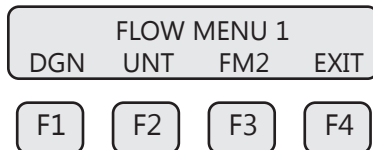

Press **FM2 (F3)** to get to Flow Menu 2.

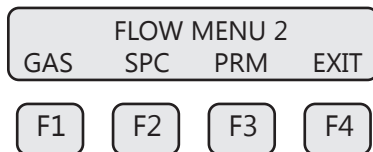

Operation: Gas-SelectX[®]

Press **GAS (F1)** to access the Gas-SelectX[®] feature.
The display may show:

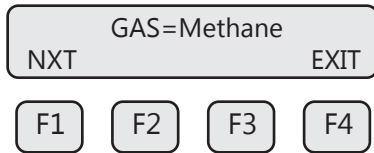

From this screen, the user will be able to access two aspects of the Gas-SelectX[®] Menu:

1. Pure Gas = Choosing from a list of available gases, or
2. Gas Mix = Programming a specific mixture of up to five gases

Choosing a Gas from the Gas-SelectX[®] Menu

The Gas-SelectX[®] Menu will show one of the available gases/gas mixtures:



Press **NXT (F1)** to choose from a list of gases. Choices are:

- Methane
- CO₂ = Carbon Dioxide
- Nitrogen
- Air
- Natural Gas (mix) **see definition p. 63*
- Argon
- Propane
- Helium
- Oxygen
- Butane
- Hydrogen
- Ethane
- %Mix = Mix of any five gases above; proportions must equal 100%

To choose any pure gas, cycle through until the correct gas is displayed and press **OK (F4)** to choose the gas.

To create a gas mix, choose %Mix from the list and press **OK (F4)**.

GAS= %Mix
NXT OK

F1 F2 F3 F4

The screen will show:

Methane=0%
CHG OK

F1 F2 F3 F4

This screen shows the percentage of the gas mixture allocated to methane. In this case, it shows 0%. To program the specific mixture of methane, press **CHG (F1)**.

Methane=30%
UP DN OK

F1 F2 F3 F4

To set the percentage of methane in the gas mix, press **UP (F1)** or **DN (F2)**.

Once the desired methane percentage is displayed, press **OK (F4)**. The display will move to the view of the concentration of each of the subsequent list of gases: Methane, Carbon Dioxide (CO2), Nitrogen, Helium, Argon, Hydrogen, Air, Propane, Butane, Oxygen, and Ethane (in that order). Natural Gas is not allowed to be part of the mix, as it is a mix itself.

CO2=0%
CHG OK

F1 F2 F3 F4



NOTE!

- Gas mix must equal 100%
- Gas mixes are limited to the combination of 5 gases.
- Any gases not included in the gas mix should have percentages set to 0%.

Operation: Gas-SelectX[®]

Once the desired gas percentages are programmed, press **OK (F4)**.
 One of the following messages will appear:

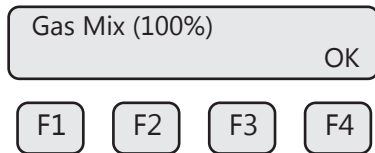

Shows only if no error is detected. Pressing OK allows exit to menu.

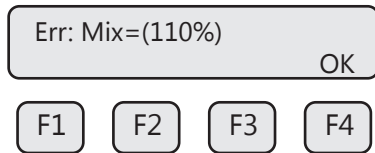

Shows only if gas mix does not equal 100%. Pressing OK returns to gas entry.

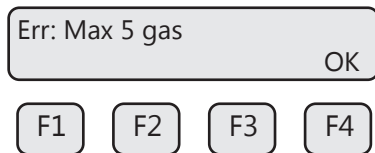

Shows only if too many gases are selected. Only five gases are allowed. Pressing OK returns to gas entry.



NOTE! The gas selection must be valid or the gas mix must have a valid 100% mixture before the user is allowed to exit.

Once the "Gas Mix (100%)" message appears, you have successfully programmed the gas mix in Gas-SelectX[®] and can exit. Press **OK (F4)** to set the mixture.

The FT1 will begin to monitor flow based on the pre-calibrated algorithm for the gas selected in the Gas-SelectX[®] feature. The screen will show the flow in units and the total flow similar to the example below:

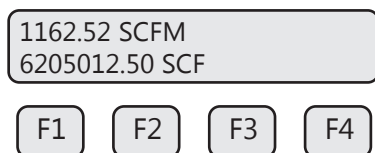

From normal operating mode, the gas selection can be seen on display 3 (see p. 41).

Scope

This portion of the manual describes the Modbus implementation using RS485 serial communication physical layer for the Fox Thermal FT1 Mass flow meter based on the Modicon Modbus Protocol (PI-MBUS-300 Rev. J).

Modbus Protocol

Modbus Protocol is an application layer messaging protocol that provides client/server communications between devices. Modbus is a request/reply protocol and offers services specified by function codes.

The size of the Modbus Protocol Data Unit is limited by the size constraint inherited from the first Modbus implementation on Serial Line network (max. RS485 Application Data Unit = 256 bytes).

Therefore, Modbus PDU for serial line communication = 256 – Server address (1 byte) – CRC (2 bytes) = 253 bytes.

RS485 ADU = 253 + Server address (1 byte) + CRC (2 bytes) = 256 bytes.

For more information on Modbus go to the web site <http://www.modbus.org/>.

Command Request:

<Meter Address> <Function code> <Register start address high> <Register start address low> <Register count high> <Register count low> <CRC high> <CRC low>

Command Response:

<Meter Address> <Function code> <Data byte count> <Data register high> <Data register low> ... <Data register high> <Data register low> <CRC high> <CRC low>



NOTE! The data shown in brackets < > represents one byte of data.

Modbus Indicators

LED indicator LP3 cycles on and off to indicate that the FT1 is operating.

LED indicator LP2 blinks when Modbus signals are received and LP1 blinks when Modbus signals are transmitted.

FT1 Commands Supported

The FT1 supports the following commands:

- 1) Command 03: Read holding registers
- 2) Command 04: Read input register.
- 3) Command 06: Preset single register
- 4) Command 16: Preset multiple registers (limited to gas percentage register pairs)

FT1 Commands Supported by Modbus

Read Holding Registers (command 03)

This command reads the basic variable from the FT1 and has the following format:

Request:

<Meter Address> <Command code=03> <Register start address high> <Register start address low> <Register count high> <Register count low> <CRC high> <CRC low>

Response:

<Meter Address> <Command code=03> <Byte count> <Data high><Data low> ... <Data high><Data low> <CRC high> <CRC low>

Example:

Request data register at starting address 0x0000 and specifying only 1 register

<0x01> <0x03> <0x00> <0x00> <0x00> <0x01> <0x0a> <0x84>

Response:

<0x01> <0x03> <0x02> <xx> <xx> <CRC high> <CRC low>

Where xx xx is the data register value. When reading values that span more than one register, the registers should be read with a single read command so that the values in the registers come from a single read of the parameter. If the registers are read by separate commands, the register contents are not guaranteed to be part of the same parameter value.

Table 5.1: FT1 Modbus Holding Registers

Modbus Register	Data Type	Description	Units
40001	32-bit int LSW	Flow	User selected
40002	32-bit int MSW		
40003	32-bit int LSW	Flow Total	User selected
40004	32-bit int MSW		
40005	32-bit int LSW	Temperature	Tenths of user selected
40006	32-bit int MSW		
40007	32-bit int LSW	Elapsed time	Tenths of user selected
40008	32-bit int MSW		
40009		Reserved	
40010		Reserved	
40011	16-bit int	Flow x 10 (flow scaled for 16 bits)	Tenths of user selected
40012	16-bit int	Flow x 100 (flow scaled for 16 bits)	Hundredths of user selected
40013	16-bit int	Total x 100 (flow total scaled for 16 bits)	Hundredths of user selected
40014		Reserved	
40015		Reserved	

FT1 Commands Supported by Modbus

Table 5.1: FT1 Modbus Holding Registers (cont'd)

Modbus Register	Data Type	Description	Units
40016	16-bit int	Status	
40017	16-bit int	Status 2	
40018	16-bit int	Control Register (Write Only): Reset total = 2 Perform CAL_V = 173 Abort CAL-V = 174	
40019		Reserved	
40020	32-bit float LSW	Flow	User selected
40021	32-bit float MSW		
40022	32-bit float LSW	Total	User selected
40023	32-bit float MSW		
40024		Reserved	
40025		Reserved	
40026	32-bit float LSW	Temperature	User selected
40027	32-bit float MSW		
40028	32-bit float LSW	Elapsed time	Hours
40029	32-bit float MSW		
40030	32-bit float LSW	Calibration validation result	
40031	32-bit float MSW		
40032		Reserved	
40033		Reserved	
40034		Reserved	
40035		Reserved	
40036		Reserved	
40037		Reserved	
40038		Reserved	
40039		Reserved	
40040		Reserved	
40041		Reserved	
40042		Reserved	
40043		Reserved	
40044		Reserved	
40045		Reserved	
40046		Reserved	
40047		Reserved	
40048		Reserved	
40049		Reserved	
40050		Reserved	

FT1 Commands Supported by Modbus

Table 5.1: FT1 Modbus Holding Registers (cont'd)

Modbus Register	Data Type	Description	Units
40051		Reserved	
40052		Reserved	
40053		Reserved	
40054		Reserved	
40055		Reserved	



- Registers 40011, 40012, and 40013 are provided to get more resolution for low flow and total. When value exceeds the 16 bit registers, they will be frozen with all 16 bits set.
- In the table, LSW means Least Significant Word, and MSW means Most Significant Word. In this case a "word" is one 16-bit Modbus register. A 32-bit float or 32-bit integer is stored in a pair of Modbus registers. When a register is designated as "32-bit int LSW", it means that bits 0-15 of the variable are in that register. A register designated as MSW has bits 16-31 of the variable. For instance, the flow total can be read as a 32-bit integer from registers 40003 (LSW) and 40004 (MSW). If the flow total is 0x12345678, then register 40003 will hold 0x5678, and register 40004 will hold 0x1234. See the layout of a 32-bit floating point value on page 78.
- 32-bit floating point values are defined by the IEEE 754 standard: <https://ieeexplore.ieee.org/document/8766229>
- Refer also to Wikipedia: https://en.wikipedia.org/wiki/Single-precision_floating-point_format

Read Input Register (FT1 Status, Command 04)

This command is used to report the FT1 status information.

Request:

<Meter Address> <Command code=04> <Register address =0> <Register address =0>
 <Register count =0> <Register count =1> <CRC high> <CRC low>

Response:

<Meter Address> <Command code=04> <Byte count =2> <Status High><Status Low>
 <CRC high> <CRC low>

FT1 Commands Supported by Modbus

Table 5.2: Status Bits Definitions for Command 04, Modbus Address 30001

Bit	Definition	Comment
0	Power up indication	Cleared when out of the power up sequence
1	Flow rate reached high limit threshold	Set limit to zero to disable
2	Flow rate reached low limit threshold	Set limit to zero to disable
3	Temperature reached high limit threshold	Set limit to zero to disable
4	Temperature reached low limit threshold	Set limit to zero to disable
5	Sensor reading is out of range	Check sensor wiring
6	Gas mix error	Gas mix must total 100%
7	Incorrect Settings	Check settings
8	In simulation mode	Set simulation value to 0 to disable
9	Pulse/alarm output is out of range	Check pulse/alarm output settings
10	Analog 4-20 mA for flow/temp is out of range	Check analog output settings
11	Not used	Not used
12	Not used	Not used
13	Not used	Not used
14	CRC error	Check parameters and reset CRC
15	Error in Total	Reset total to clear alarm

Table 5.3: Status 2 Bits Definitions for Command 04, Modbus Address 30002

Bit	Definition	Comment
0	Pulse hardware detected	
1	Busy	Busy
2	Not used	Not used
3	Not used	Not used
4	CAL-V in process	
5	CAL-V fail	
6	CAL-V aborted	
7	CAL-V warning	

FT1 Commands Supported by Modbus

Preset Single Register (Command 06)

This command writes a single register. This should not be used to write to register pairs because it may produce a corrupted setting. For instance, if you use two of these commands to write to a pair of registers that hold a floating point value, the value will be a combination of the old and new values after the first write and before the second. When you want to write to a single register, it is just as well to use Preset Multiple Registers (Command 16), and specify a single register.

Request:

<Meter Address> <Command code=06> <Register address MSB> <Register address LSB>
<Register data LSB> <Register data MSB> <CRC MSB> <CRC LSB>

Response:

<Meter Address> <Command code=06> <Register address MSB> <Register address LSB>
<Register data MSB> <Register data LSB> <CRC MSB> <CRC LSB>

Preset Multiple Registers (Command 16)

This command is restricted to writing to the gas mix percentage settings in registers 40058 – 40091. The preset single register command is not allowed to write to these registers. The percentage settings are 32-bit floating point numbers in units of percent. A setting of 12.7 means 12.7%.

Request message:

<Meter Address> <Command code=16 (0x10)> <Starting register address MSB> <Starting register address LSB> <Number of registers MSB> <Number of registers LSB> <Byte count>
<Register data MSB> <Register data LSB> ... <Register data MSB> <Register data LSB> <CRC LSB> <CRC MSB>

Response message:

<Meter Address> <Command code=16 (0x10)> <Starting register address MSB> <Starting register address LSB> <Number of registers high> <Number of registers low> <CRC LSB>
<CRC MSB>

Modbus Programming

Communication Protocol and Parameters

To program the communication parameters, start at the Main Menu:

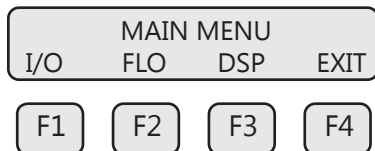

Then press **I/O (F1)** to set Inputs/Outputs:

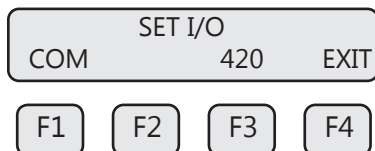

Then press **COM (F1)** to select communication parameters.

Set Bus protocol for Modbus:

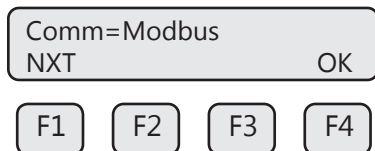

Press **NXT (F1)** repeatedly until Modbus is selected as shown and then press **OK (F4)** to accept the setting.

The following communication parameters are only available for Modbus:

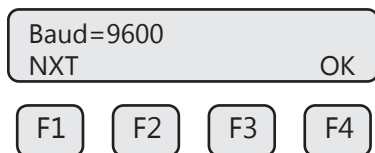

Press **NXT (F1)** repeatedly until the correct selection is shown and then press **OK (F4)** to accept the setting.

Selections are:

- "115200"
- "76800"
- "57600"
- "38400"

Modbus Programming

"19200"

"9600"

"4800"

"2400"

"1200"

Parity=EVEN	OK
NXT	

F1	F2	F3	F4
----	----	----	----

Press **NXT (F1)** repeatedly until the correct selection is shown and then press **OK (F4)** to accept the setting.

Selections are:

"NONE"

"ODD"

"EVEN"

Address=02	OK
CHG	

F1	F2	F3	F4
----	----	----	----

Press **CHG (F1)** to change the address and then press **OK (F4)** to accept the setting.

Selections are between 01 and 247.



NOTE! Power cycle is required for the new settings to take effect.

Using Modbus to Program Gas-SelectX®

Modbus can be used to access and program gases/gas mixes in the Gas-SelectX® feature available on the Model FT1.

Selecting FT1 Gases and Gas Mixes

Modbus register 40057 selects the gas type, which may be either a pure gas, a standard mix (natural gas) or either of two custom mix types (oil & gas or generic mix). Register 40057 will read zero, and register 40056 will read the gas selection that was chosen. Writing to register 40056 will produce an error response. See Table 5.4 for the values to write.

Modbus Programming

Table 5.4: Gas Selection Codes

Selection Code	Gas
0	Methane
1	CO2 (Carbon Dioxide)
2	Nitrogen
3	Helium
4	Argon
5	Hydrogen
6	Air
7	Propane
8	n-Butane
9	Reserved
10	Oxygen
11	Ethane
12	Iso Butane
13	Pentane
14	Hexane
15	Heptane
16	Octane
17	Nonanes
250	Mixed gas (must set percentages)

Setting Mix Percentages

When a custom mix type is selected, the percentages of each gas in the mix must be set. These percentages are 32-bit floating point numbers. Each constituent gas has a pair of registers to hold its percentage.

Table 5.5: FT1 Modbus Holding Registers for Gas-SelectX®

40056	16-bit int	Gas type selection	See table of gas selection codes for Modbus
40057	16-bit int	Gas type selection	
40058	32-bit float LSW	Methane (C1) percentage	Percent (31.4 = 31.4%)
40059	32-bit float MSW		
40060	32-bit float LSW	Carbon Dioxide percentage	Percent (31.4 = 31.4%)
40061	32-bit float MSW		
40062	32-bit float LSW	Nitrogen percentage	Percent (31.4 = 31.4%)
40063	32-bit float MSW		
40064	32-bit float LSW	Air percentage	Percent (31.4 = 31.4%)
40065	32-bit float MSW		
40066	32-bit float LSW	Argon percentage	Percent (31.4 = 31.4%)
40067	32-bit float MSW		
40068	32-bit float LSW	Propane percentage	Percent (31.4 = 31.4%)
40069	32-bit float MSW		

Modbus Programming

40070	32-bit float LSW	Helium percentage	Percent (31.4 = 31.4%)
40071	32-bit float MSW		
40072	32-bit float LSW	Oxygen percentage	Percent (31.4 = 31.4%)
40073	32-bit float MSW		
40074	32-bit float LSW	n-Butane percentage	Percent (31.4 = 31.4%)
40075	32-bit float MSW		
40076	32-bit float LSW	Hydrogen percentage	Percent (31.4 = 31.4%)
40077	32-bit float MSW		
40078	32-bit float LSW	i-Butane percentage	Percent (31.4 = 31.4%)
40079	32-bit float MSW		
40080	32-bit float LSW	Ethane percentage	Percent (31.4 = 31.4%)
40081	32-bit float MSW		
40082	32-bit float LSW	Pentane percentage	Percent (31.4 = 31.4%)
40083	32-bit float MSW		
40084	32-bit float LSW	Hexane percentage	Percent (31.4 = 31.4%)
40085	32-bit float MSW		
40086	32-bit float LSW	Heptane percentage	Percent (31.4 = 31.4%)
40087	32-bit float MSW		
40088	32-bit float LSW	Octane percentage	Percent (31.4 = 31.4%)
40089	32-bit float MSW		
40090	32-bit float LSW	Nonane percentage	Percent (31.4 = 31.4%)
40091	32-bit float MSW		

**NOTES!**

- In the table, LSW means Least Significant Word, and MSW means Most Significant Word. In this case a "word" is one 16-bit Modbus register. A 32-bit float or 32-bit integer is stored in a pair of Modbus registers. When a register is designated as "32-bit int LSW", it means that bits 0-15 of the variable are in that register. A register designated as MSW has bits 16-31 of the variable. For instance, the flow total can be read as a 32-bit integer from registers 40003 (LSW) and 40004 (MSW). If the flow total is 0x12345678, then register 40003 will hold 0x5678, and register 40004 will hold 0x1234. See the layout of a 32-bit floating point value on page 78.
- 32-bit floating point values are defined by the IEEE 754 standard: <https://ieeexplore.ieee.org/document/8766229>
- Refer also to Wikipedia: https://en.wikipedia.org/wiki/Single-precision_floating-point_format

BACnet Introduction

Scope

This portion of the manual describes the BACnet MS/TP (RS485) implementation using RS485 serial communication physical layer for the Fox Thermal FT1 Mass flow meter.

BACnet Protocol

BACnet MS/TP (Building Automation and Control Network/Master Slave Token Passing) is a data link layer protocol designed for communication between devices in building automation control systems. The protocol is based on devices, objects, properties, and services. Information inside a BACnet device is organized into a series of objects. Properties allow the data from the object to be written or read. The actions that a BACnet device uses to interact with another device are the services.

The FT1 Device profile: BACnet Smart Sensor (B-SS)

FT1 supports the following device binding methods:

Receive Who-Is, send I-Am (BIBB DM-DDB-B)
Receive Who-Has, send I-Have (BIBB DM-DOB-B)

Objects for FT1:

Analog Input 1 = Flow
Analog Input 2 = Gas Temperature
Analog Input 3 = Total Flow / Reset Total
Analog Input 4 = Elapsed Time since reset

BACnet Indicators

LED indicator LP3 cycles on and off to indicate that the FT1 is operating.

LED indicator LP2 blinks when BACnet signals are received and LP1 blinks when BACnet signals are transmitted.

Device object property identifiers and restrictions: (properties that are writable)

Object _Name	< 10 bytes
Object _ Identifier	Device Type only
Max _ info_ Frames	<=255
Max _ Master	<=127

BACnet Interoperability Building Blocks (BIBB'S) provide function capabilities for data exchange between devices.

BACnet Protocol

FT1 BIBB's supported:

DS-RP-B Read Property
DS-WP-B Write Property
DM-DDB-B Dynamic Device Binding
DM-DOB-B Dynamic Object Binding
DM-DCC-B Device Communication Control
DS-RPM-B ReadPropertyMultiple
DM-RD-B Reinitialize Device

MS/TP baud rates:

9600, 19200, 38400, 57600, 76800, 115200

FT1 Character sets supported:

ANSI X3.4, UTF-8

Fox Thermal BACnet vendor ID: 650

For more information about BACnet visit <http://www.bacnet.org/>.

BACnet Programming

Communication Protocol and Parameters

To program the communication parameters, press **I/O (F1)** key from the Main Menu.

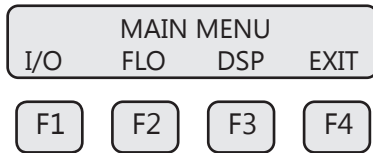

This is the Main Menu for the programming mode. To exit the programming mode, press **EXIT (F4)** repeatedly until "Normal Mode" is seen briefly. Choose I/O (F1) to access the communication output.

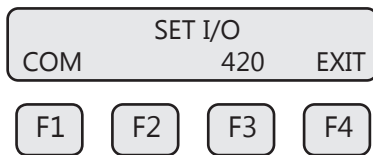

Then press **COM (F1)** to select communication parameters

Set Bus protocol for BACnet:

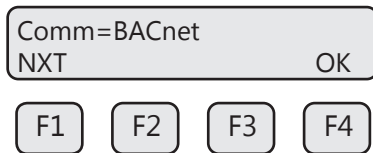

Press **NXT (F1)** until BACnet is selected as shown and then press **OK (F4)** to accept the setting.

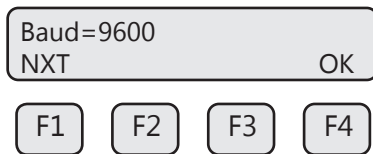

Press **NXT (F1)** repeatedly until the correct selection is shown and then press **OK (F4)** to accept the setting.

Selections are:

- "9600"
- "19200"
- "38400"
- "57600"
- "76800"
- "115200"

BACnet Programming

Next select the MS/TP Mac address. The selection is from 0-127. Please note that only one device can be on a MS/TP Mac address.

MAC_ADD=23 CHG	OK		
F1	F2	F3	F4

Next select the MS/TP Max Master using **CHG (F1)**. The selection is from 0-127. Press **OK (F4)** to accept the setting.

MAX_MASTER=127 CHG	OK		
F1	F2	F3	F4

Next input the device object instance using **CHG (F1)**. Selection is from 0-4194303. Press **OK (F4)** to accept the setting.

ID=12531 CHG	OK		
F1	F2	F3	F4

Next enter the device object name (9 characters maximum) using **CHG (F1)**. Press **OK (F4)** to accept the setting.

NAME=FT1_FLOW CHG	OK		
F1	F2	F3	F4



NOTE! Power cycle is required for the new settings to take effect.

HART Introduction

Scope

The Fox Thermal Model FT1 transmitter complies with HART Protocol Revision 7.1. This section specifies all the device-specific features and documents HART Protocol implementation details (e.g., the Engineering Unit Codes supported). The functionality of this Field Device is described sufficiently to allow its proper application in a process and its complete support in HART-capable Host Applications.

Purpose

This section provides a complete description of this Field Device from a HART Communication perspective.

The specification in this section is designed to be a technical reference for HART capable Host Application Developers, System Integrators and knowledgeable End Users. It also provides functional specifications (e.g., commands and performance requirements) used during development, maintenance and testing. The information given in this section assumes the reader is familiar with HART Protocol requirements and terminology.

References

HART Smart Communications Protocol Specification. HCF_SPEC-12. Available from the HCF.

Device Identification

<i>Manufacturer Name:</i>	<i>Fox Thermal Instruments, Inc.</i>	<i>Model Name(s):</i>	<i>FT1</i>
<i>Manufacturer ID Code:</i>	<i>24635 (603b hex)</i>	<i>Device Type Code:</i>	<i>57583 (EOEF Hex)</i>
<i>HART Protocol Revision</i>	<i>7.1</i>	<i>Device Revision:</i>	<i>1</i>
<i>Number of Device Variables</i>	<i>None</i>		
<i>Physical Layers Supported</i>	<i>FSK</i>		
<i>Physical Device Category</i>	<i>Transmitter, DC-isolated Bus Device</i>		

HART Protocol

Product Overview

HART communication is transmitted over the FT1 4-20mA flow output signal and can be monitored and configured using a HART master device or a hand-held communicator.

Process Flow Rate 4-20mA Analog Output

The 4-20mA output of the FT1 HART represents the process flow rate measurement, linearized and scaled according to the configured range of the instrument. This output corresponds to the Primary Variable. HART Communication is supported on this loop.

The 4-20mA output of the FT1 should be configured for flow rate when using HART. If the 4-20mA output is set to report temperature, HART communication will report the 4-20mA value for temperature rather than flow.

HART Indicators

LED indicator LP3 cycles on and off to indicate that the FT1 is operating.

LED indicator LP2 blinks when HART signals are received and LP1 blinks when HART signals are transmitted (if nothing is connected to the 4-20mA output, LP2 will be on continuously).

FT1 HART Communication Setup

HART communication must be selected in the FT1 Serial Communication Menu for HART communication to operate. When this communication parameter is changed, power to the FT1 must be cycled for it to take effect.



NOTE! Power cycle is required for the new settings to take effect.

Device Variables

This device does not expose any Device Variables.

Dynamic Variables

Four Dynamic Variables are implemented.

	Meaning	Units
PV	Flow Rate	In Selected Units
SV	Total	In Selected Units
TV	Temperature	In Selected Units
QV	Elapsed Time	In Hours

Status Information

Device Status

Bit 4 ("More Status Available") is set when any failure is detected. Command #48 provides additional detail.

Extended Device Status

This bit is set if a sensor error is detected. "Device Variable Alert" is set if the PV is out of limit.

Additional Device Status (Command #48)

Command #48 returns 2 Device-Specific Status bytes of data, with the following status information. These bits are set when an alarm or error condition is present. The bit automatically clears when the condition returns to its normal state.

Byte	Bit	Meaning	Class
0	0	Power up indication	Status
	1	High Flow Limit Alarm	Alarm
	2	Low Flow Limit Alarm	Alarm
	3	High Temperature Limit Alarm	Alarm
	4	Low Temperature Limit Alarm	Alarm
	5	Sensor out of range	Error
	6	Mix error	Alarm
	7	Check Parameter Settings	Error
1	0	In Simulation Mode	Alarm
	1	Frequency output out of range	Alarm
	2	CH 1 4-20mA out of range	Alarm
	3	Not used	
	4	Not used	
	5	Not used	
	6	CRC database error	Error
	7	Error with Total	Error

HART Programming

Common-Practice Commands, Supported Commands

The following common-practice commands are implemented:

- 34 Write Damping Value
- 35 Write Range Values
- 36 Set PV Upper Range Values
- 37 Set PV Lower Range Values
- 38 Reset "Configuration Changed" Flag
- 40 Enter/Exit Fixed Current Mode
- 44 Write PV Units
- 45 Trim Loop Minimum
- 46 Trim Loop Maximum
- 48 Read Additional Device Status (Command #48 returns 2 bytes of data)
- 59 Write Number of Response Preambles

Common-Practice Commands, Unsupported Commands

Burst Mode- This device does not support Burst Mode.

Catch Device Variable- This device does not support Catch Device Variable.

Device-Specific Commands- No Device-Specific commands are implemented.

Modes

Fixed current mode is implemented, using Command 40. This mode is cleared by power loss or reset.

Damping

Damping is standard, affecting only the PV and the loop current signal.

HART Programming

Capability Checklist

<i>Manufacturer, model</i>	<i>Fox Thermal Instruments, FT1</i>
Device type	Transmitter
HART revision	7.1
Device Description available	No
Number and type of sensors	1
Number and type of actuators	0
Number and type of host side signals	1 : 4-20mA analog
Number of Device Variables	0
Number of Dynamic Variables	4
Mappable Dynamic Variables	No
Number of common-practice commands	17
Number of device-specific commands	0
Bits of additional device status	8
Alternative operating modes	No
Burst mode	No
Write-protection	Yes

HART Programming

Communication Protocol and Parameters

To program the communication parameters, press **I/O (F1)** key from the Main Menu.

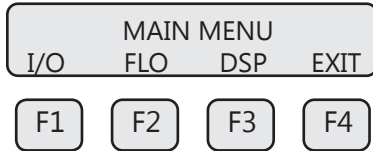

This is the Main Menu for the programming mode. To exit the programming mode, press **EXIT (F4)** repeatedly until "Normal Mode" is seen briefly. Choose I/O (F1) to access the communication output.

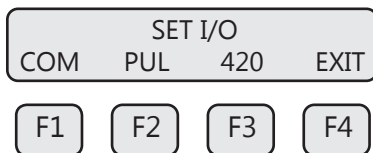

Then press **COM (F1)** to select communication parameters

Set Bus protocol for HART:

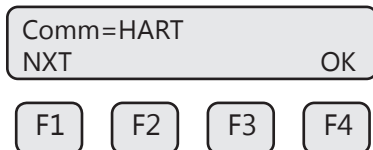

Press **NXT (F1)** until HART is selected as shown and then press **OK (F4)** to accept the setting.

Power cycle is required for the new settings to take effect.

PRECAUTIONS



WARNING! BEFORE ATTEMPTING ANY MAINTENANCE, TAKE THE NECESSARY SAFETY PRECAUTIONS BEFORE REMOVING THE PROBE FROM THE DUCT (EXAMPLE: PURGE LINES OF TOXIC AND/OR EXPLOSIVE GAS, DEPRESSURIZE, ETC...).



WARNING! EXPLOSION HAZARD. DO NOT REMOVE OR REPLACE COMPONENTS OR FUSES UNLESS POWER HAS BEEN DISCONNECTED WHEN A FLAMMABLE OR COMBUSTIBLE ATMOSPHERE IS PRESENT.



WARNING! EXPLOSION HAZARD. DO NOT DISCONNECT EQUIPMENT WHEN A FLAMMABLE OR COMBUSTIBLE ATMOSPHERE IS PRESENT.

Access to Electronics

Accessing electronics is not normally required for maintenance purposes. If a loose connection is suspected, unscrew the cap of the meter, unscrew the two phillips captive screws through the display and open the display assembly to access the wiring terminations.



CAUTION! BE SURE POWER TO METER IS SWITCHED OFF BEFORE ATTEMPTING TO ACCESS ELECTRONICS. If there is a problem and a loose connection is not found, please contact Fox Thermal Customer Service for technical assistance at (831) 384-4300.

Broken or Damaged Probe

If the sensor is broken or damaged, the probe and electronics must be returned to the factory for repair. A new sensor will be installed and calibrated. Refer to "Returning Your Meter" on p. 107.

Flow Calibration and Calibration Validation

To ensure continued high accuracy of your Model FT1 Flow Meter, Fox Thermal provides a full NIST traceable calibration. It is recommended that the meter's accuracy be checked annually by performing the CAL-V™ Calibration Validation test.

Fuse Replacement

WARNING! *Turn input power OFF before removing or installing a fuse. Use only recommended fuse replacements.*

Verify the fuse is defective by measuring it with an Ohm Meter (Two replacement fuses are provided with each unit). Replacement fuse is Littelfuse part number 0454.750MR

To replace the fuse:

The fuse F1 is located near the power terminal block and can be removed by using tweezers or needle-nose pliers.

Sensor Cleaning

The sensor is insensitive to small amounts of residue, but continued use in dirty environments will necessitate periodic cleaning. To inspect the sensor, remove power from electronics and remove the unit from the pipe or duct, exposing the sensor elements. If they are visibly dirty, clean them with water or alcohol (ethanol) using an appropriate brush until they appear clean again. Even though the sensor elements are rugged, avoid touching them with any solid object and use a light touch while cleaning them.

Maintenance: Retractor Option

Instructions for Removing and Inserting the Meter from a Pressurized Pipe using the Retractor



WARNING! Possible injury or damage to equipment may occur if the retractor is not used correctly. Please read the following instructions carefully prior to using the retractor.



CAUTION! Never remove the restraint cable without first closing the Ball Valve and bleeding off pressure.



WARNING! When working with the retractor, do not stand or position any part of your body in the path of the flow meter. An injury may occur if the probe is forced outward by system pressure.

How to Remove the Meter from the Retractor (System Pressurized)

Step 1 - Remove the Probe from the Flow Stream

1. Disconnect power from the meter.



NOTE! At 150psig of max system pressure, the probe will have approximately 66 lbs. of force pushing it out.

2. System pressure may force the probe out of the retractor when the compression nut is loosened. Hold the flow meter to counteract the force of the system pressure, and carefully loosen and unscrew the compression nut.
3. While supporting the meter, slowly slide the probe out of the retractor until the restraint cable is tight.
4. Close the ball valve all the way.



CAUTION! At this point there is still pressure inside of the retractor.

Figure 6.1

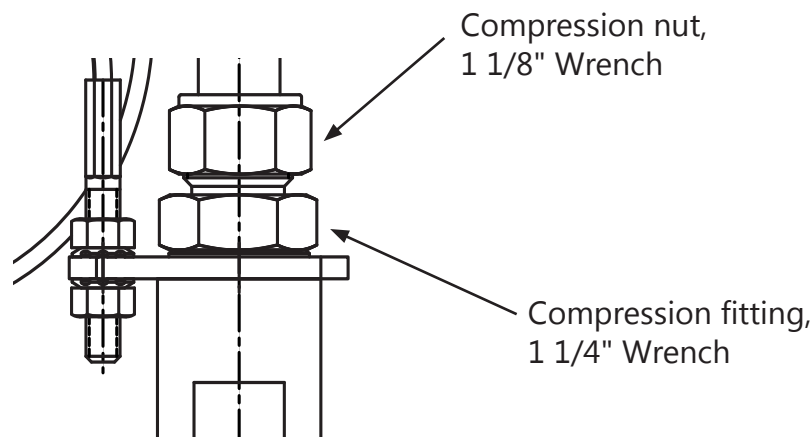

Maintenance: Retractor Option

Step 2 - Remove the Probe from the Retractor Body

5. After removing the probe from the flow stream and closing the ball valve (#1-4 on previous page), slowly loosen the compression fitting (see figure 8.2), until the pressure in the retractor is relieved.
6. Retighten the compression fitting.
7. Remove the Collar Clamp by using a 3/16" Hex Key.
8. Carefully slide the probe out of the retractor while supporting the meter.

Figure 6.2

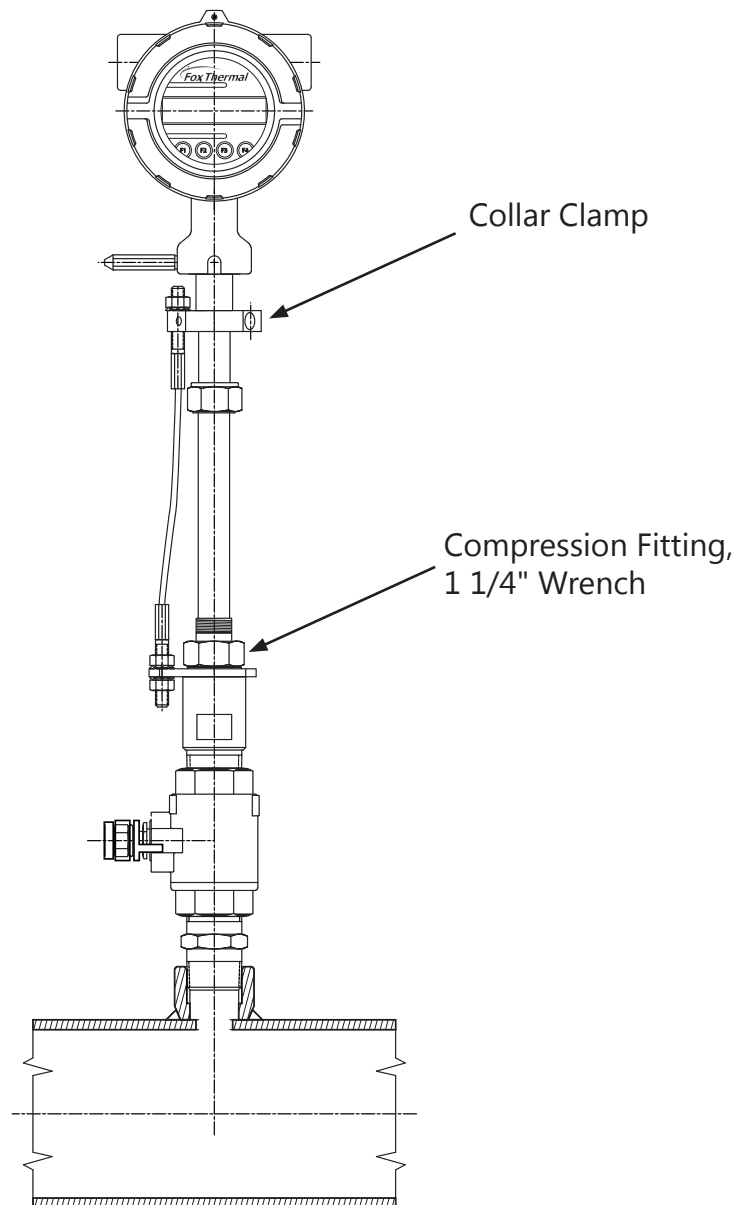

Maintenance: Retractor Option

How to Insert the Probe into the Flow Stream (Valve closed, System Pressurized)

1. Carefully, slide the probe into the retractor.
2. Install the collar clamp just below the collar spacer, and tighten it in place on the probe. Slide the probe back out of the retractor until the cable is straight and taut.

Figure 6.3

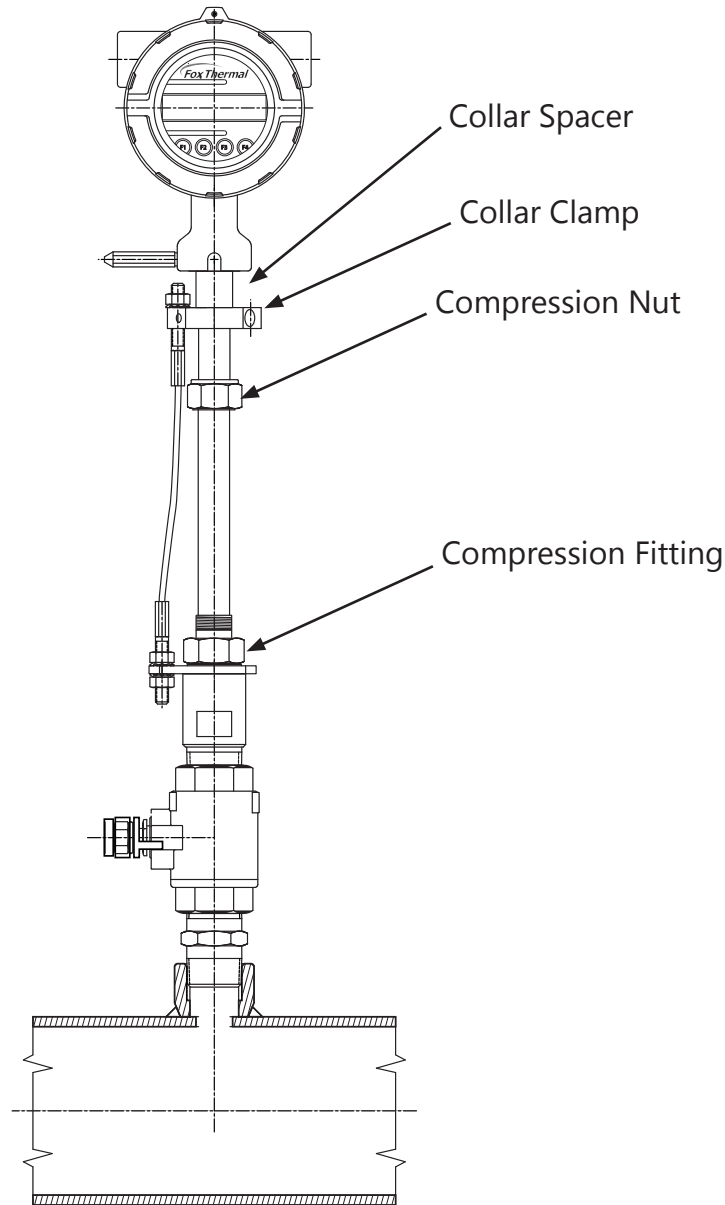

NOTE! At a maximum system pressure of 150psig, the force required to push the probe in place to tighten the compression fitting will be approximately 66 lbs.

3. Slowly open the ball valve to the full open position. Push the meter and probe into the pipe, then hand tighten the compression nut onto the compression fitting.

Maintenance: Retractor Option

4. Verify that the probe is aligned with the centerline of the pipe, and pointed in the direction of flow.

Figure 6.4

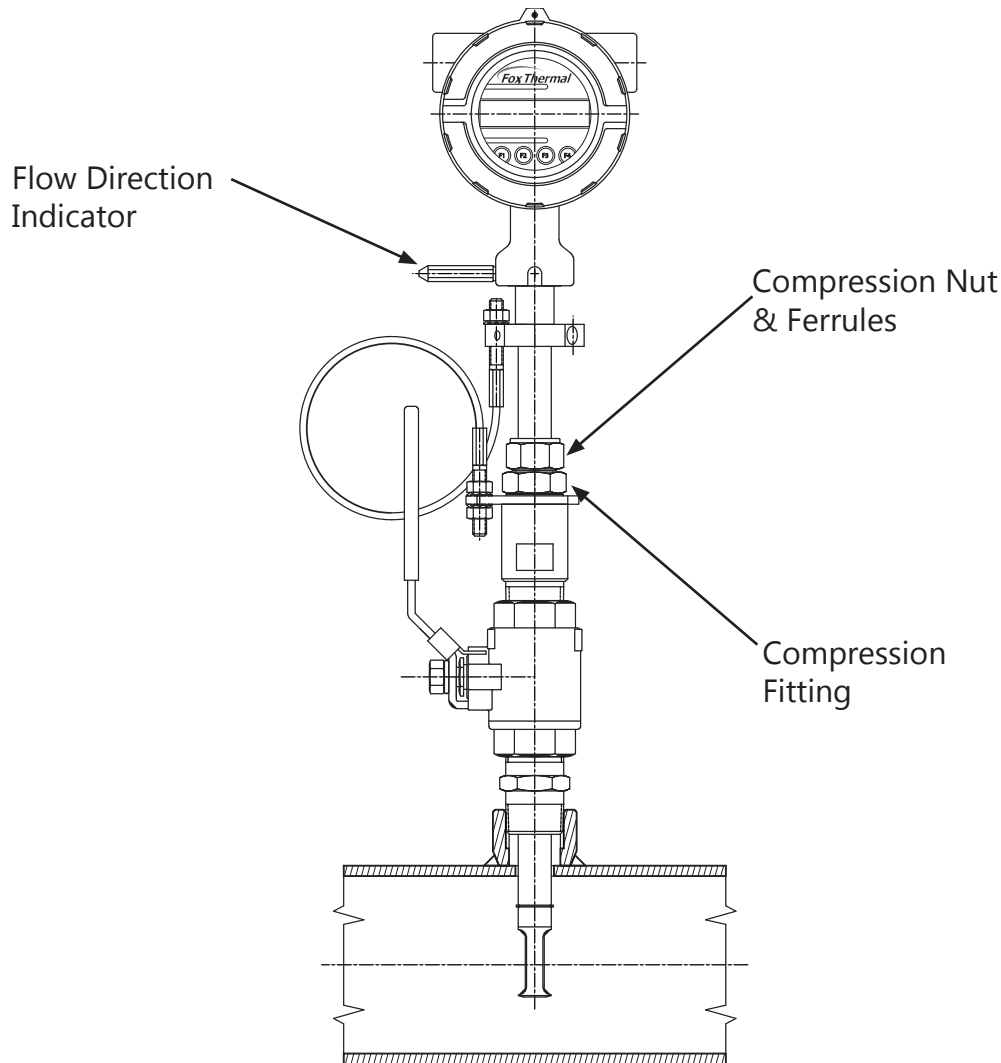

5. Secure the probe in place by tightening the compression nut with a 1 1/8" wrench and a 1 1/4" wrench on the compression fitting. See p. 24 of the manual for detailed instructions to tighten the compression nut.
6. Power may now be applied to the meter.



Troubleshooting



CAUTION! The electronics and sensor supplied by Fox Thermal are calibrated as a single precision mass flow meter. Interchanging sensors will decrease the accuracy of the flow meter. If you experience any problem with your Model FT1 Flow meter, call Fox Thermal Customer Service Department, Technical Assistance at (831) 384-4300.

LED Indicators

The LED indicators near the terminal blocks of the FT1 display the status of the FT1. The Heartbeat LED blinks fast when the FT1 is powered up, and blinks about once a second when the FT1 operates normally.

The Transmit and Receive LEDs blink when messages are sent and received through serial communication. The Receive LED may be illuminated if the FT1 has HART communication and the 4-20mA output is not connected.

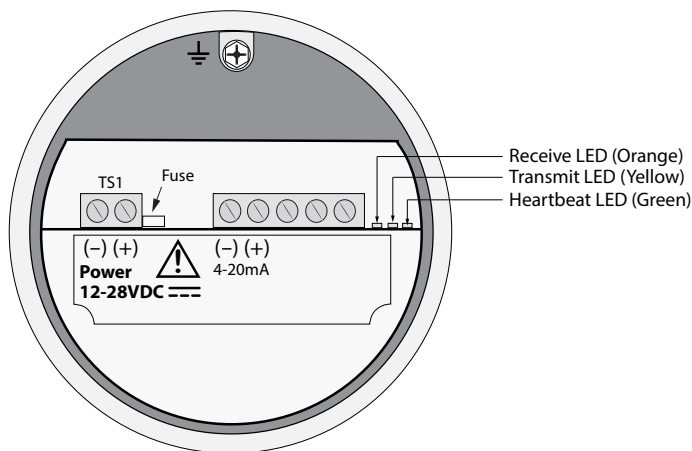

Problem	Possible Cause(s)	Action(s)
Display not operating properly	<ol style="list-style-type: none"> Loose or damaged ribbon cable Temperature below -20°C 	<ol style="list-style-type: none"> Visual inspection. Cycle the power to reset the meter. Display should operate when ambient temperature is above -20°C
Flow measurement seems low	<ol style="list-style-type: none"> Probe not oriented properly Sensor dirty 	<ol style="list-style-type: none"> Orient probe per installation sections: Insertion (p. 17), Perform CAL-V™ test (p. 60) Clean sensor (p. 89)
Unit will not power-up	<ol style="list-style-type: none"> No power input Power connections reversed Bad Power supply Bad fuse 	<ol style="list-style-type: none"> Check for correct power supply voltage at TS1 on main board. Check fuse (F1) located next to TS1 on main board. <p>If fuse is OK and unit still won't power up, call Fox Thermal for additional assistance</p>



Problem	Possible Cause	Action
Meter resets	<ol style="list-style-type: none"> 1. Electromagnetic interference (EMI) 2. Low power supply voltage or intermittent power 	<ol style="list-style-type: none"> 1. Check meter power cycles value 2. Press and release F1 and F2 at the same time; the display will enter Engineering screens. 3. Press F1 to get to screen #23; record power cycle value. 4. Press F4 to return to normal operation; monitor meter until problem returns. 5. Return to screen #23 to see if power cycles have increased; microprocessor is resetting due to EMI electrical noise entering the meter. 6. Check Power input and output cables grounding and routing.
Flow measurement is erratic or fluctuating	<ol style="list-style-type: none"> 1. Very turbulent flow 2. Sensor dirty 3. Sensor broken 4. Probe not mounted securely 5. Malfunction in flow meter 6. Meter installed incorrectly 7. Low power supply voltage or intermittent power 8. Moisture in the gas stream 	<ol style="list-style-type: none"> 1. Increase dampening (see filter settings in "Flow Parameters" on p. 53) 2. Clean sensor (Refer to Maintenance section, p. 89) 3. Return flow meter to Fox Thermal for repair (Refer to p. 107 for shipping instructions) 4. Remount probe (see Installation section, p. 17); must be mounted securely without vibration. If vibration persists, choose a new mounting location without vibration. 5. Return flow meter to Fox Thermal for repair (Refer to p. 107 for shipping instructions) 6. Re-install meter according to instructions (Refer to installation section, p. 17) 7. Check Power input and output cables grounding and routing. 8. Consider a tilt installation (Refer to installation section, p. 19).



Troubleshooting CAL-V™

If the FT1 Meter fails a CAL-V™ Calibration Validation test, there are a few reasons that could be the cause:

1. The sensor may be dirty or damaged
 - Visually inspect the meter and sensor for damage. If damage is found, meter may need to be serviced. Contact Fox Thermal Technical Assistance at 831-384-4300 for more information.
 - Try cleaning the sensor and try the test again. Please refer to Maintenance section for more information (p. 89).
 - If the meter fails again, contact Fox Thermal Technical Assistance at 831-384-4300 for more information.



Installation Problems

The following is a summary listing of problems that may be encountered with the installation of the FT1 Thermal Mass Flow Meter.

- 1. Improper wiring connections for power and/or 4-20mA output signal.*
A separate power source is recommended for the FT1 main board and the 4-20mA output signals. Two wires supply 24VDC power to the main board. Two wires are used for the 4-20mA output signals. Refer to Figure 3.3 and Figure 3.4 (p. 33, p. 34). Also refer to "Wiring Precautions" in Wiring section (p. 21) for further guidance.
- 2. Inadequate power source.*
The FT1 requires 12 to 28VDC at 6 Watts to operate. A 20 Watt or larger power supply is recommended for powering the FT1 to ensure it operates properly under all conditions. If the voltage supplied at the input terminals of the FT1 is not within the range of 10VDC to 30VDC, a variety of problems can occur including a dim display, inaccurate flow readings or faulty 4-20mA, pulse and communication interface.
- 3. Flow measurement seems inaccurate.*

 - Check to ensure that the flow meter is installed so that the Flow Direction Indicator below the electronics housing is properly pointing in the direction of flow. Refer to Figure 2.3 (p. 22). If not, change orientation of the sensor.
 - Check that the insertion depth of the sensor/probe is correct. The end of the probe should be adjusted as per Figure 2.2 (p. 21).
 - For insertion meters, ensure that there are a minimum of fifteen diameters of straight pipe upstream of the sensor and ten diameters downstream. For inline meters, ensure that there are a minimum of ten diameters of straight pipe upstream of the sensor and five diameters downstream. If complex flow disturbances are upstream of the sensor, extension of the straight pipe may be required to ensure accurate flow measurement. Contact Fox Thermal for assistance.
 - Ensure that pipe inside diameter in the meter matches data on the Fox Thermal Calibration Certificate. The pipe inside diameter is programmed into the flow meter through the front panel (see Flow Parameters, p. 53).
- 4. Erratic flow reading (especially a flow reading spiking high).*
This may be a symptom of moisture in the flow stream. Fox Thermal flow meters are designed to work in relatively dry gas applications only. Contact Fox Thermal to discuss resolutions to this problem.
- 5. Flow meter is not responding to flow.*

 - Check to ensure adequate power is supplied to the flow meter. If things appear to be correct, perform this functional test before calling Fox Thermal. Carefully remove the probe and sensor from the pipe. For those flow meters with a display - and if the display is reading zero - blow on the sensor to see if a response occurs. If nothing happens, take a damp rag or sponge and place it in contact with the sensor. A reading should occur. Contact Fox Thermal Customer Service with this information.
- 6. Display and/or 4-20mA signal reading above zero flow when no flow is occurring in the pipe.*
If the reading is less than 5% of full scale, it is likely this is a normal condition caused by convection flow in the pipe. It does not mean that the zero of the instrument is improperly set. The Fox Thermal sensor is extremely sensitive to gas flow and can even read the small flow caused by convection. If this is an unacceptable condition, please contact Fox Thermal Customer Service for alternatives.



Alarm Codes

Information to diagnose and clear alarm codes is on p. 9 under the Menu Tree section. Enter password (9111) and follow the block diagram to get to the section affected by the error code.

Alarm Code	Reason	Action
13	Flow rate above high limits	Refer to the Flow Menu 2 section on p. 53 of this Manual to verify limit is within range. Check ALM = HiFloAlm under PRM.
14	Flow rate below low limits	Refer to the Flow Menu 2 section on p. 53 of this Manual to verify limit is within range. Check ALM = LoFloAlm under PRM.
15	Temperature above high limits	Refer to the Flow Menu 2 section on p. 53 of this Manual to verify limit is within range. Check ALM=HiTempAlm under PRM.
16	Temperature below low limits	Refer to the Flow Menu 2 section on p. 53 of this Manual to verify limit is within range. Check ALM = LoTempAlm
22	Sensor out of range	Refer to the Engineering Display Menu on p. 13 of this Manual to check CSV voltage. The CSV voltage in Display 10 must be within the range of 0.002 to 0.3125 volts.
23	Gas mix error	Gas mix must equal 100%.
25	Simulation mode	Meter is in Simulation Mode. Refer to the Flow Menu 1 section on p. 58 of this Manual. Use the SIM Section under Diagnostics to return to normal operation.
26	Pulse/alarm output over range	Refer to the Digital Output Menu on p. 7 of this Manual. Verify the Pulse/alarm Output settings are within limits.
32	4-20mA is out of range	Refer to the Main Menu on p. 6 of this Manual. Use the Set I/O section to verify range limits.
34	Busy	Meter is recalculating new parameters.
36	Database CRC Error	Refer to the Reset CRC section on p. 57 of this manual. Verify the programmed values are verified and corrected before clearing the error. Contact Fox Thermal Service Department for possible causes.

Appendices: Specifications

Performance Specs

Flow Accuracy:

- Air: $\pm 1\%$ of reading $\pm 0.2\%$ of full scale
- Other gases: $\pm 1.5\%$ of reading $\pm 0.5\%$ of full scale
- Accuracy specification applies to customer's selected flow range
- Maximum range: 15 to 25,000 SFPM (0.07 to 118 NMPS)
- Minimum range: 15 to 500 SFPM (0.07 to 2.4 NMPS)
- Straight, unobstructed pipe requirement:
 - Insertion meters: 15 diameters upstream; 10 downstream
 - Inline meters: 8 diameters upstream; 4 downstream

Flow Repeatability: $\pm 0.2\%$ of full scale

Flow Response Time: 0.8 seconds (one time constant)

Temperature Accuracy: $\pm 1^\circ\text{F}$ ($\pm 0.6^\circ\text{C}$)

Calibration:

- Factory Calibration to NIST traceable standards
- CAL-V™: In situ, operator-initiated calibration validation

Operating Specs

Gas-SelectX® Gas Selections:

Methane, Carbon Dioxide (CO₂), Nitrogen, Air, Natural Gas, Argon, Propane, Helium, Oxygen, Ethane, Butane, Hydrogen, and a 5-gas mix. See the Fox Thermal website for more information on availability of current gases.

Units of Measurement (field selectable):

SCFM, SCFH, NM³/H, NM³/M, KG/H, KG/M, KG/S, LB/H, LB/M, LB/S, NLPH, NLPM, MMSCFD, LB/D, SLPM, NLPS, MSCFD, SM³/H, MT/H, NM³/D, MMSCFM, SCFD, MCFD, SM³/M, SM³/D

Flow Velocity Range:

15 to 25,000 SFPM at 70°F (0.07 to 118 NMPS at 0°C)
 Turndown: up to 1000:1; 100:1 typical

Flow Ranges - Insertion Meters			
Size	SCFM	MSCFD	NM ³ /hr
1.5" (40mm)	0-354	0-510	0-558
2" (50mm)	0-583	0-840	0-920
2.5" (63mm)	0-830	0-1,310	0-1,200
3" (80mm)	0-1,280	0-1,840	0-2,020
4" (100mm)	0-2,210	0-3,180	0-3,480
6" (150mm)	0-5,010	0-7,210	0-7,910
8" (200mm)	0-8,680	0-12,500	0-13,700
10" (250mm)	0-13,600	0-19,600	0-21,450
12" (300mm)	0-19,400	0-27,900	0-30,600

NOTE: To determine if the FT1 will operate accurately in other pipe sizes, divide the maximum flow rate by the pipe area. The application is acceptable if the resulting velocity is within the velocity range above. Check Fox Thermal website for velocity calculator.

Flow Ranges - Inline Meters			
Size	SCFM	MSCFD	NM ³ /hr
.75"	0-93	0-134	0-146
1.00"	0-150	0-216	0-237
1.25"	0-260	0-374	0-410
1.50"	0-354	0-510	0-558
2.00"	0-583	0-840	0-920
2.50"	0-830	0-1,310	0-1,200
3.00"	0-1,280	0-1,840	0-2,020
4.00"	0-2,210	0-3,180	0-3,480
6.00"	0-2,500	0-3,600	0-3,950

NOTE: Standard conditions of air at 70°F and one atmosphere. Consult factory for other gases and for flow ranges above those listed. Inline meters above 2,500 SCFM (3,950 NM³/H) air may require third party calibration. Contact Fox Thermal.

Appendices: Specifications

Operating Specs (cont'd)

Gas Pressure (maximum):

Insertion meter: 740 psig (51 barg)

316 SS inline meter with NPT ends: 500 psig (34 barg)

316 SS inline meter with 150 lb. flanges: 230 psig (16 barg)

Carbon steel inline meter with NPT ends: 500 psig (34 barg)

Carbon steel inline meter with 150 lb. flanges: 285 psig (20 barg)

Retractor Assembly: 150 psig (10.3 barg)

NOTE: When teflon ferrule option ordered, gas pressure is 60 psig (4.1 barg) maximum

NOTE: Pressure ratings stated for temperature of 100°F (38°C).

Relative Humidity: Non-condensing

NOTE: Condensing liquids contacting the sensor can cause erratic flow indication.

Temperature:

DDC-Sensor™: -40 to 250°F (-40 to 121°C)

Enclosure: -40 to 158°F (-40 to 70°C)*

*NOTE: Display dims below -4°F (-20°C), function returns once temperature rises again.

Input Power: 12 to 28VDC, 6 watts minimum

Full Input Power Range: 10 to 30VDC.

A 20 Watt or greater power supply is recommended to power the FT1.

Outputs:

Channel 1:

Standard isolated 4-20mA output configured to indicate either flow or temperature; fault indication per NAMUR NE43.

The 4-20mA load resistance must be 125 ohms or less when operating on 12 volt power and 600 ohms or less on 24 volt power.

HART communication option

Channel 2:

FT1 can be ordered with either the pulse output or serial communication option.

- Pulse option: Isolated open collector output rated for 5 to 24VDC, 20mA maximum load, 0 to 100Hz (the pulse output can be configured to either transmit a 0 to 100Hz signal proportional to flow rate or an on/off alarm).
- Serial communication option: Isolated Modbus RTU (RS485) or BACnet MS/TP (RS485).

USB Communication:

Isolated USB 2.0 for interfacing with a laptop or computer is standard.

FT1 View™: A free PC-based software tool that provides complete configuration, remote process monitoring, and data logging functions through USB communication.

4-20mA and Pulse Verification:

Simulation mode used to align 4-20mA output and pulse output (if ordered) with the input to customer's PLC/DCS.

Appendices: Specifications

Physical Specs

Probe diameter: 3/4"

Sensor material: 316 stainless steel

Enclosure: NEMA 4X, aluminum, dual 3/4" FNPT conduit openings.

Flow Meter Installation: Fox Thermal-supplied compression fitting connects to customer-supplied 3/4" female branch outlet welded to pipe.

Agency Approvals

CE Mark: Approved

EMC Directive; 2014/30/EU

Electrical Equipment for Measurement, Control, and Lab Use: EN61326-1:2013

Pressure Equipment Directive: 2014/68/EU

Weld Testing: EN ISO 15614-1 and EN ISO 9606-1, ASME B31.3

FM (FM16US0005X) and FMc (FM16CA0005X): Approved

Class I, Division 1, Groups B,C,D;

Class II, Division 1, Groups E,F,G;

Class III, Division 1; T4, Ta = - 40°C to 70°C;

Class 1, Zone 1, AEx/Ex db IIB + H2 T4; Gb Ta = -40°C to 70°C;

Type 4X, IP66/67

ATEX (FM16ATEX0013X): Approved

II 2 G Ex db IIB + H2 T4; Gb Ta = - 40°C to 70°C; IP66/67

II 2 D Ex tb IIIC T135°C; Db Ta = - 40°C to 70°C; IP66/67

IECEX (IECEX FMG 16.0010X): Approved

Ex db IIB + H2 T4; Gb Ta = - 40°C to 70°C; IP66/67

Ex tb IIIC T135°C; Db Ta = - 40°C to 70°C; IP66/67

ATEX and IECEX Standards:

EN 60079-0:2012 + A11:2013

IEC 60079-0:2011

EN 60079-1:2014

IEC 60079-1:2014

EN 60079-31:2014

IEC 60079-31:2013

EN 60529:1991 + A1:2000

IEC 60529:2001

Appendices: Dimensions

Fig. 7.1 Insertion Meter Dimensions
Measurements shown in inches (millimeters).

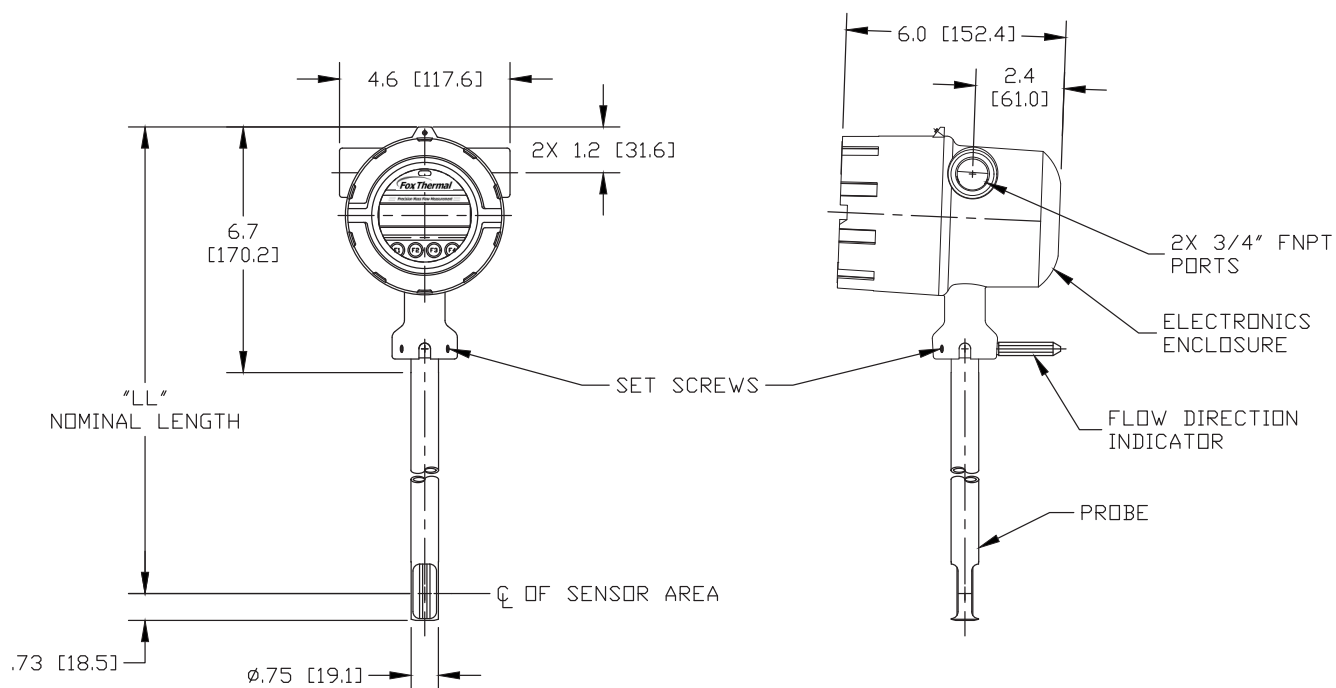

Table 7.1 Insertion Meter with 316 stainless steel probe

Probe Size [model code]	Probe Size [inches]	Dimension "LL" [inches / millimeters]
06I	6"	6.0" (152 mm)
09I	9"	9.0" (229 mm)
12I	12"	12.0" (305 mm)
15I	15"	15.0" (381 mm)
18I	18"	18.0" (457 mm)
24I	24"	24.0" (610 mm)
30I	30"	30.0" (762 mm)
36I	36"	36.0" (914 mm)

Appendices: Dimensions

Fig. 7.2 Insertion Meter with 150 psig Retractor Dimensions
Measurements shown in inches (millimeters).

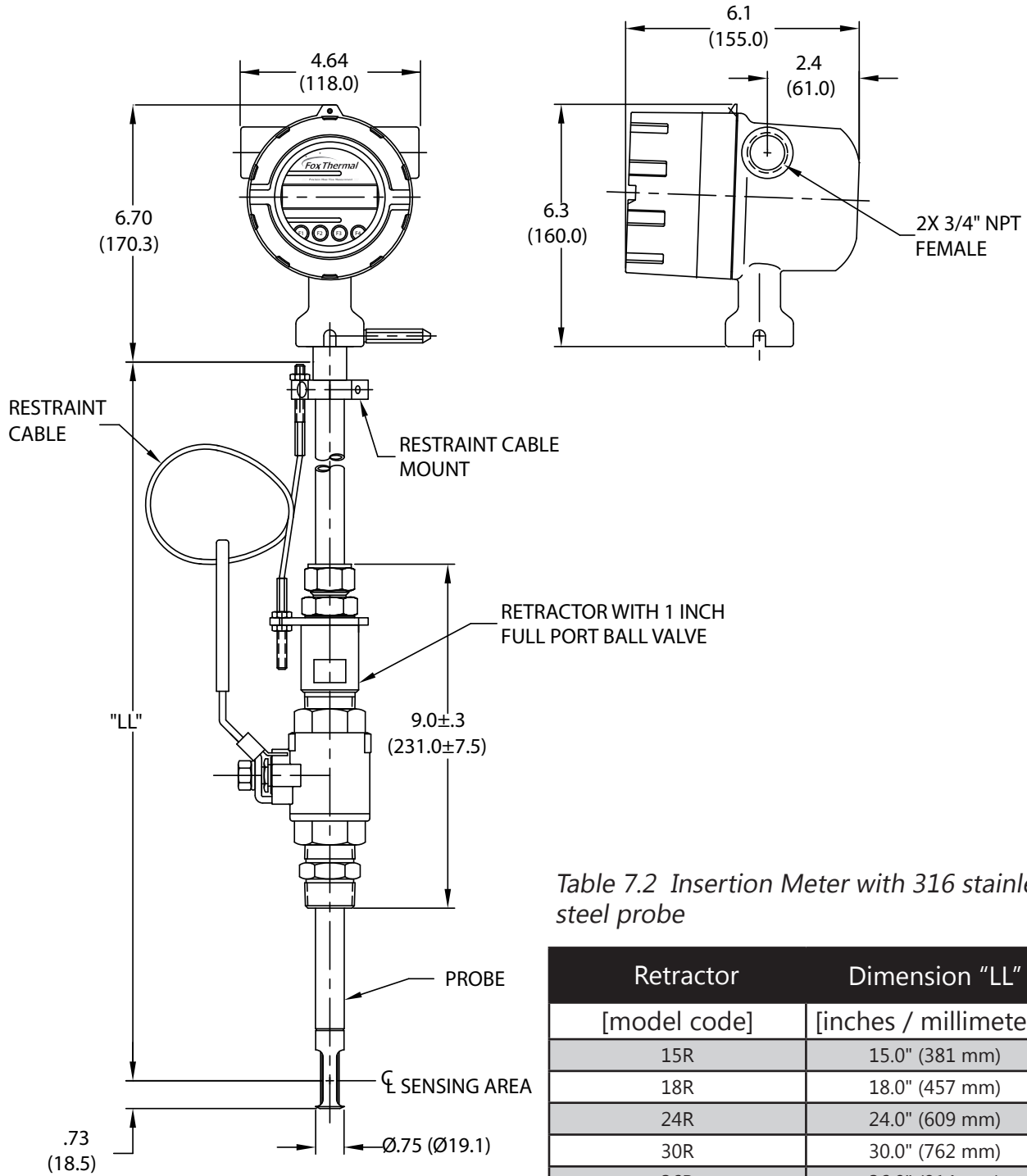

Table 7.2 Insertion Meter with 316 stainless steel probe

Retractor [model code]	Dimension "LL" [inches / millimeters]
15R	15.0" (381 mm)
18R	18.0" (457 mm)
24R	24.0" (609 mm)
30R	30.0" (762 mm)
36R	36.0" (914 mm)

Appendices: Dimensions

Fig. 7.3 Inline Meter with Flow Body and NPT End Connections - Dimensions
Measurements shown in inches (millimeters).

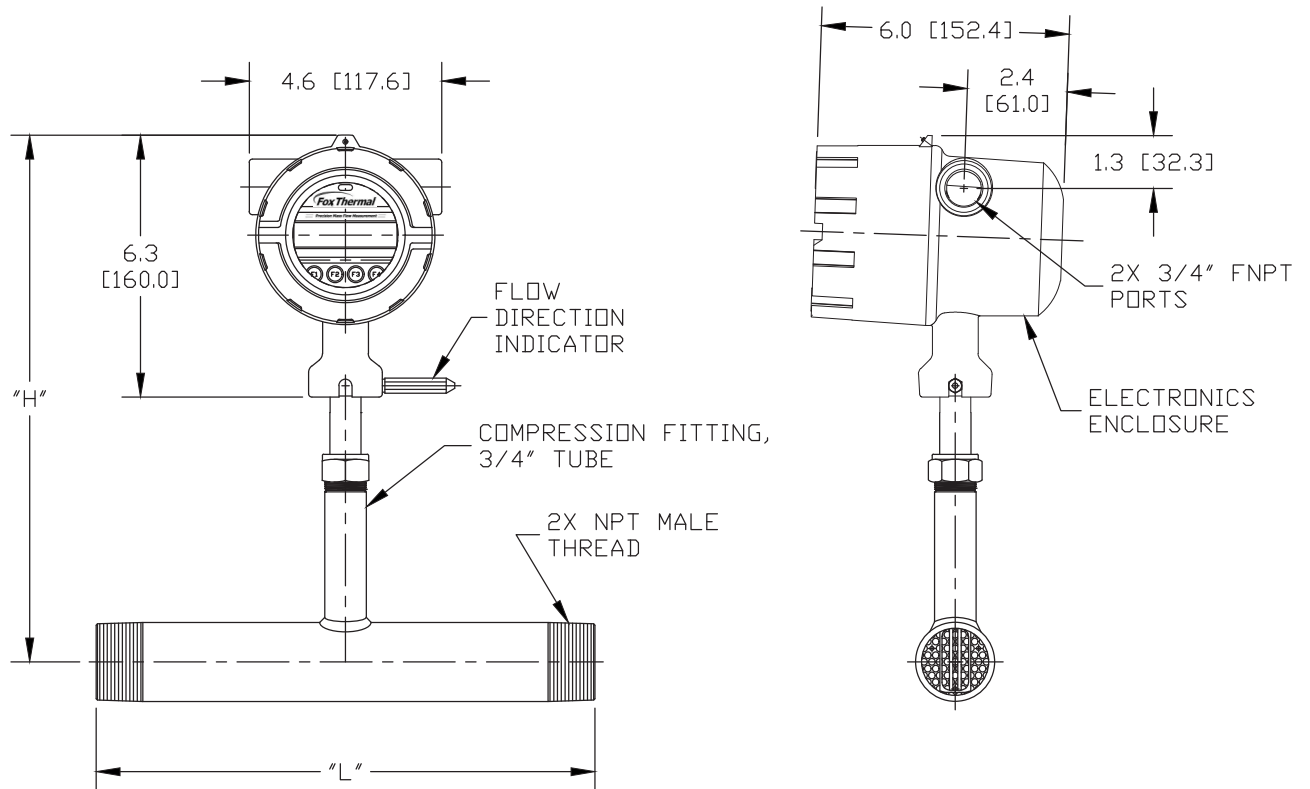

Table 7.3 Inline Meter with Flow Body and NPT End Connections

Size [model code]	Body Size [inches]	Dimension "L" [inches]	Dimension "H" [inches / millimeters]
075P*	0.75"	12"	10.7" (271.8mm)
10P*	1.00"	12"	10.7" (271.8mm)
125P*	1.25"	12"	10.7" (271.8mm)
15P*	1.50"	12"	12.7" (322.6mm)
20P**	2.00"	12"	12.7" (322.6mm)
25P**	2.50"	18"	12.7" (322.6mm)
30P**	3.00"	18"	12.7" (322.6mm)

*available in 316 Stainless Steel only

**available in 316 Stainless Steel or A106 Grade B Carbon steel pipe

Appendices: Dimensions

Fig. 7.4 Inline Meter with Flow Body and 150lb RF Flange End Connections - Dimensions
Measurements shown in inches (millimeters).

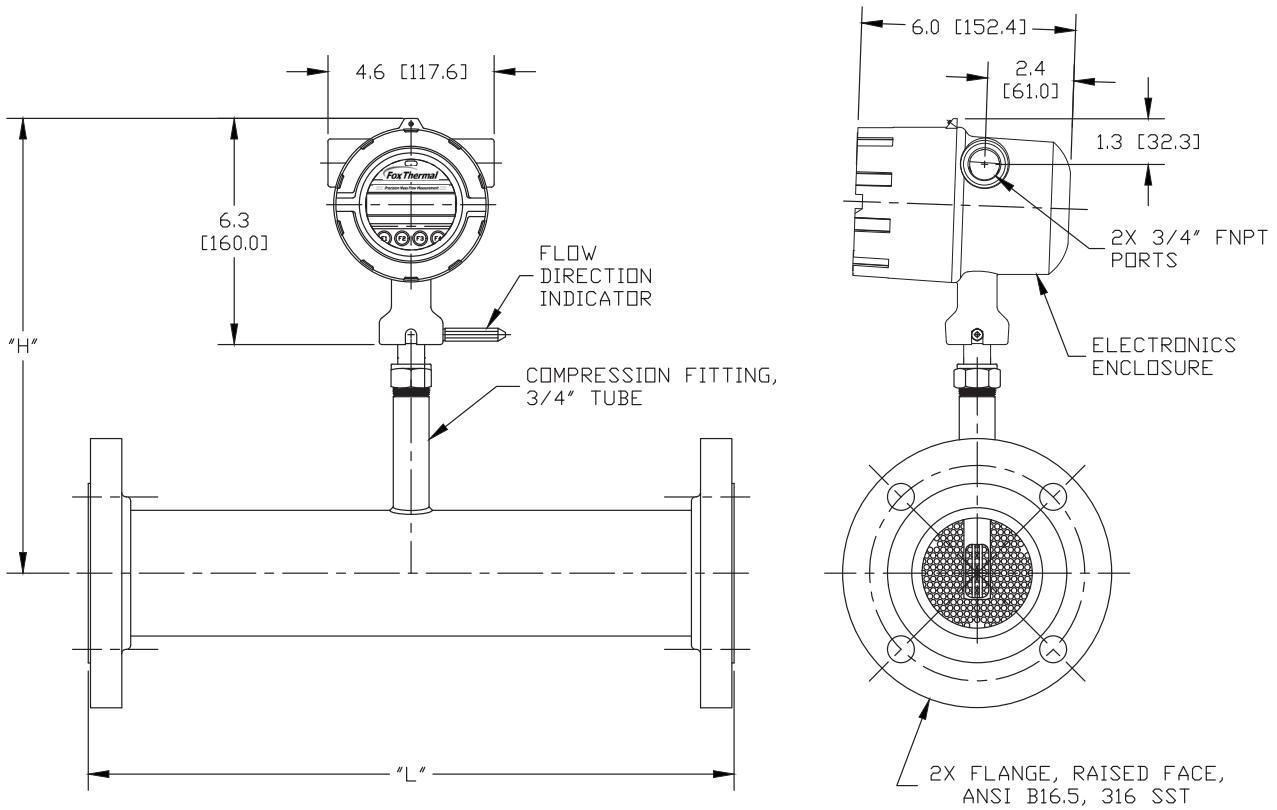

Table 7.4 Inline Meter with Flow Body and 150lb RF Flange End Connections - Dimensions

Size	Body Size	Dimension "L"	Dimension "H"
[model code]	[inches]	[inches]	[inches / millimeters]
075F*	0.75"	12"	10.7" (271.8mm)
10F*	1.00"	12"	10.7" (271.8mm)
125F*	1.25"	12"	10.7" (271.8mm)
15F*	1.50"	12"	12.7" (322.6mm)
20F**	2.00"	12"	12.7" (322.6mm)
25F**	2.50"	18"	12.7" (322.6mm)
30F**	3.00"	18"	12.7" (322.6mm)
40F**	4.00"	18"	12.7" (322.6mm)
60F**	6.00"	24"	12.7" (322.6mm)

*available in 316 Stainless Steel only

**available in 316 Stainless Steel or A106 Grade B Carbon steel pipe

Warranty

(a) Fox Thermal (hereafter FOX) warrants that the products furnished under this Agreement will be free from defects in material and workmanship for a period of one year from the date of shipment. The customer shall provide notice of any defect to FOX, within one week after the Customer's discovery of such defect. The sole obligation and liability of FOX, under this warranty shall be repair or replace, at its option, without cost to the Customer, the defective product or part.

(b) Upon request by FOX, the product or part claimed to be defective shall immediately be returned at the Customer's expense to FOX. Replaced or repaired products or parts will be shipped to the Customer at the expense of FOX. FOX shall have the right of final determination as to the existence and cause of defect.

(c) There shall be no warranty or liability for any products or parts that have been subject to misuse, accident, negligence, failure of electric power or modifications by the Customer without the written approval of FOX. Final determination of warranty eligibility shall be made by FOX. If a warranty claim is considered invalid for any reason, the Customer will be charged for services performed and expenses incurred by FOX, in handling and shipping the returned unit.

(d) The liability of FOX shall be limited to replacing or repairing, at its option, any defective parts which are returned. Labor and related expenses incurred to install replacement parts are not covered by this warranty.

(e) As to replacement parts supplied or repairs made during the original warranty period, the warranty period for the replacement or repaired part shall terminate with the termination of the warranty period of the original product or part.

(f) The use of these products is under exclusive control of the purchaser and FOX specifically denies any responsibility for the calibration of units and/or accuracy of work performed or the safety of the system in which FOX products is used. EXTERNAL SAFETY DEVICES MUST BE USED WITH THIS EQUIPMENT.

(g) No warranty is made with respect to custom equipment or products produced to Buyer's specifications except as specifically stated in writing by FOX and contained in the agreement.

(h) THE FOREGOING WARRANTY CONSTITUTES THE SOLE LIABILITY OF FOX, AND THE CUSTOMER'S SOLE REMEDY WITH RESPECT TO THE PRODUCTS AND IS IN LIEU OF ALL OTHER WARRANTIES, INCLUDING ANY WARRANTY OF MERCHANTABILITY OR FITNESS FOR A PARTICULAR PURPOSE, LIABILITIES, AND REMEDIES. EXCEPT AS THUS PROVIDED, FOX, DISCLAIMS ALL WARRANTIES, EXPRESS OR IMPLIED, INCLUDING ANY WARRANTY OF MERCHANTABILITY OR FITNESS FOR A PARTICULAR PURPOSE.

Appendices: Returning Your Meter

Returning Your Meter

The Fox Thermal Customer Service Department (PH: 831-384-4300 or FAX: 831-384-4312) can help you through the process of returning a meter for service.

If it becomes necessary to return a Fox Thermal flow meter for service or recalibration, please follow these steps:

1. A Return Material Authorization (RMA) Number must be obtained from the Fox Thermal Customer Service Department prior to returning any Fox Thermal meter(s).
2. Please have your meter's serial number(s) available.
3. Read and complete the Fox Thermal RMA Customer Information Form (download from the Fox Thermal website). Be sure to initial the decontamination statement as well as provide complete return shipping instructions (we cannot deliver to post office boxes).
4. The entire flow meter must be returned, including all electronics (unless specifically instructed to do otherwise). **ALL** serial numbers must match their corresponding meters. This is especially necessary when returning flow body models.
5. Clean and decontaminate all wetted parts before returning to Fox Thermal.
6. Ship the meter to the following address:

Fox Thermal Instruments, Inc.
399 Reservation Road
Marina, CA 93933
Attn: Service Dept.
[RMA Number]



NOTE! Be sure to review all of the information on the Customer Information Form before sending your meter to the Fox Thermal Customer Service Department. The Fox Thermal Shipping/Receiving Department cannot accept meters that have not been prepared appropriately.

What to expect while your meter is being serviced

Depending on the type of service required when returning your Fox Thermal meter, there are varying turnover times for servicing a meter. The average time needed to service the meter is 7-10 days (not including shipping or peak production times).

If you have already shipped your meter to Fox Thermal for servicing and would like to check the status of your meter, please fill out our online Service Order Status form located at www.foxthermal.com and you will hear from a Customer Service Rep within 1 business day of your requested update.

Rush recalibration service is available for a fee. Restrictions apply.

Glossary of Terms and Definitions

AWG	American Wire Gauge	P/U	Pulse per Unit
Bara	Bar absolute	PIP A ²	Pipe Area
CTC	Contact	PLC	Programmable Logic Controller
CAL	Calibration		
CHG	Change	PRM	Parameters
COM	Communication	PRS	Pressure
CSV	Current Sense Voltage	PSIA	Pounds per Square Inch Absolute
DC	Direct Current		
DN	Down	Pt	Point
DSP	Display	PSW	Password
ELP	Elapsed time	SIM	Simulation
Feq	Frequency	SCF	Standard Cubic Feet
Ft ²	Square Feet	SCFM	Standard Cubic Feet per Minute
I/O	Input/Output		
INP	Input	SCFH	Standard Cubic Feet per Hour
IR	Infrared (IR Buttons = optical switches)	SCFD	Standard Cubic Feet per Day
		SPC	Special Control
LB	Pound	STP	Standard Temperature and Pressure
LB/D	Pound per Day		
LB/H	Pound per Hour	TMP	Temperature
LB/M	Pound per Minute	TSI	Internal Variable
LB/S	Pound per Second	TSV	Internal Variable
LCD	Liquid Crystal Display	UNT	Unit
KG	Kilogram	U/P	Unit per Pulse
KG/H	Kilogram per Hour	420	4-20mA output
KG/M	Kilogram per Minute		
KG/S	Kilogram per Second		
M ²	Square Meter		
mmHG	Pressure in millimeters of mercury		
MMSCFD	Million Standard Cubic Feet per Day		
MXFLO	Maximum Flow		
NEMA	National Electrical Manufacturers Association		
NIST	National Institute of Standards and Technology		
NL	Normal Liter		
NLPH	Normal Liter per Hour		
NLPM	Normal Liter per Minute		
NM3	Normal cubic Meter		
NM3/H	Normal cubic Meter per Hour		
NM3/M	Normal cubic Meter per Minute		
NPT	National Pipe Thread		
PDA	Personal hand held computer		
PC	Personal Computer		

Index

Index

- Access to Electronics, p. 21
- Alarm Codes, p. 98
- Alarm wiring, p. 34
- Analog 4-20mA output, p. 43
- Breakage or Damage of Probe, p. 89
- Dimension Details, p. 102
- Discrete output setting, p. 47
- Display Screens, p. 41
- Display Setup, p. 48
- Engineering Screens, p. 13
- Entering the programming mode, p. 42
- Filter value, p. 54
- Flow Meter Placement, p. 18
- Flow Units, p. 50
- Pulse/alarm Output, p. 45
- Fuse Replacement, p. 89
- Glossary, p. 108
- Installation,
 - Compression Fitting - Insertion, p. 30
 - General Precautions, p. 16
 - Lateral Placement, p. 18
 - Mounting, p. 18
 - Orientation of Meter - Insertion, p. 22
- Introduction, p. 14
- K Factor, p. 56
- Level 2 password, p. 50
- Local Display, p. 16
- Local Input Wiring, p. 31
- Mass Flow, p. 14
- Measurement Mode, p. 41
- Menu Tree,
 - Digital Output, p. 7
 - Display Menu, p. 10
 - Engineering Display, p. 11
 - Gas-SelectX®, p. 12
 - Main Menu, p. 6
 - Flow Menu 1, p. 8
 - Flow Menu 2, p. 9
 - CAL-V™ Menu, p. 11
- Mounting meter, p. 18
- Orientation of meter - Insertion type, p. 22
- Password
 - Level 1, p. 50
 - Level 2, p. 50
 - Programming, p. 50
- Power Input Wiring, p. 31
- Preventative Maintenance, p. 89
- Product Description, p. 14
- Programming
 - Analog 4-20mA Output, p. 43
 - Alarm Output, p. 47
 - Changing values or strings, p. 42
 - Display Setup, p. 48
 - Filter value, p. 54
 - Flow cutoff, p. 54
 - Flow Parameters, p. 53
 - Flow and maximum pulse/alarm, p. 46
 - High Alarm Limit value, p. 54
 - Pulse/alarm Output, p. 45
 - K Factor, p. 56
 - Low Alarm Limit value, p. 55
 - Password, p. 50
 - Pipe Diameter, p. 54
 - Programming Mode, p. 42
 - Pulse-per-unit, p. 46
 - Restore Database, p. 56
 - Reset CRC, p. 57
 - Reset Total/Elapsed Time, p. 58
 - Selecting from a list, p. 42
 - Serial Communication, p. 48
 - Simulation, p. 58
 - Unit-per-pulse, p. 46
 - Unit settings, p. 50
 - Using the Local Display, p. 42
- Replacements Fuses, p. 89
- Restore Database, p. 56
- Reset Total/Elapsed Time, p. 58
- Return Procedure, p. 107
- Sensor Cleaning, p. 89
- Sensor Orientation, p. 22
- Simulation Mode, p. 58
- Theory of Operation, p. 14
- To program the display, p. 49
- Totalizer Rollover, p. 58
- Troubleshooting, p. 94
 - Alarm Codes, p. 98
 - General, p. 95
 - Installation Problems, p. 97
- USB Interface, p. 40
- Warranty, p. 103
- Wiring
 - Alarms, p. 34
 - Pulse/Alarm Outputs, p. 34
 - Grounding, p. 30
 - Input - Local, p. 31
 - Instructions, p. 30
 - Local meters, p. 31
 - Power Input, p. 31
 - Precautions, p. 30



Wiring



Definition of Terms



Troubleshooting Tips



NOTE! is used for Notes and Information



WARNING! is used to indicate a hazardous situation which, if not avoided, could result in death or serious injury.



CAUTION! is used to indicate a hazardous situation which, if not avoided, could result in minor or moderate injury.



Indicates compliance with the WEEE Directive. Please dispose of the product in accordance with local regulations and conventions.



Indicates compliance with the applicable European Union Directives for Safety and EMC (Electromagnetic Compatibility Directive 2014/30/EU).

IP67

Enclosure Protection Classification per IEC 60529: Protected against the ingress of dust and Immersion.