

# Rosemount™ 470XA Gas Chromatograph



## Notice

EMERSON ("SELLER") SHALL NOT BE LIABLE FOR TECHNICAL OR EDITORIAL ERRORS IN THIS MANUAL OR OMISSIONS FROM THIS MANUAL. SELLER MAKES NO WARRANTIES, EXPRESSED OR IMPLIED, INCLUDING THE IMPLIED WARRANTIES OF MERCHANTABILITY AND FITNESS FOR A PARTICULAR PURPOSE, WITH RESPECT TO THIS MANUAL AND, IN NO EVENT, SHALL SELLER BE LIABLE FOR ANY SPECIAL OR CONSEQUENTIAL DAMAGES INCLUDING, BUT NOT LIMITED TO, LOSS OF PRODUCTION, LOSS OF PROFITS, ETC.

PRODUCT NAMES USED HEREIN ARE FOR MANUFACTURER OR SUPPLIER IDENTIFICATION ONLY AND MAY BE TRADEMARKS/REGISTERED TRADEMARKS OF THESE COMPANIES.

THE CONTENTS OF THIS PUBLICATION ARE PRESENTED FOR INFORMATIONAL PURPOSES ONLY AND, WHILE EVERY EFFORT HAS BEEN MADE TO ENSURE THEIR ACCURACY, THEY ARE NOT TO BE CONSTRUED AS WARRANTIES OR GUARANTEES, EXPRESSED OR IMPLIED, REGARDING THE PRODUCTS OR SERVICES DESCRIBED HEREIN OR THEIR USE OR APPLICABILITY. WE RESERVE THE RIGHT TO MODIFY OR IMPROVE THE DESIGNS OR SPECIFICATIONS OF SUCH PRODUCTS AT ANY TIME.

SELLER DOES NOT ASSUME RESPONSIBILITY FOR THE SELECTION, USE, OR MAINTENANCE OF ANY PRODUCT. RESPONSIBILITY FOR PROPER SELECTION, USE, AND MAINTENANCE OF ANY SELLER PRODUCT REMAINS SOLELY WITH THE PURCHASER AND END-USER.

## Warranty

1. **LIMITED WARRANTY:** Subject to the limitations contained in Section 2 herein and except as otherwise expressly provided herein, Emerson ("Seller") warrants that the firmware will execute the programming instructions provided by Seller and that the Goods manufactured or Services provided by Seller will be free from defects in materials or workmanship under normal use and care until the expiration of the applicable warranty period. Goods are warranted for twelve (12) months from the date of initial installation or eighteen (18) months from the date of shipment by Seller, whichever period expires first. Consumables and Services are warranted for a period of 90 days from the date of shipment or completion of the Services. Products purchased by Seller from a third party for resale to Buyer ("Resale Products") shall carry only the warranty extended by the original manufacturer. Buyer agrees that Seller has no liability for Resale Products beyond making a reasonable commercial effort to arrange for procurement and shipping of the Resale Products. If Buyer discovers any warranty defects and notifies Seller thereof in writing during the applicable warranty period, Seller shall, at its option, promptly correct any errors that are found by Seller in the firmware or Services, or repair or replace F.O.B. point of manufacture that portion of the Goods or firmware found by Seller to be defective, or refund the purchase price of the defective portion of the Goods/Services. All replacements or repairs necessitated by inadequate maintenance, normal wear and usage, unsuitable power sources, unsuitable environmental conditions, accident, misuse, improper installation, modification, repair, storage or handling, or any other cause not the fault of Seller are not covered by this limited warranty, and shall be at Buyer's expense. Seller shall not be obligated to pay any costs or charges incurred by Buyer or any other party except as may be agreed upon in writing in advance by an authorized Seller representative. All costs of dismantling, reinstallation and freight, and the time and expenses of Seller's personnel for site travel and diagnosis under this warranty clause shall be borne by Buyer unless accepted in writing by Seller. Goods repaired and parts replaced during the warranty period shall be in warranty for the remainder of the original warranty period or ninety (90) days, whichever is longer. This limited warranty is the only warranty made by Seller and can be amended only in a writing signed by an authorized representative of Seller. Except as otherwise expressly provided in the Agreement, THERE ARE NO REPRESENTATIONS OR WARRANTIES OF ANY KIND, EXPRESSED OR IMPLIED, AS TO MERCHANTABILITY, FITNESS FOR PARTICULAR PURPOSE, OR ANY OTHER MATTER WITH RESPECT TO ANY OF THE GOODS OR SERVICES. It is understood that corrosion or erosion of materials is not covered by our guarantee.
2. **LIMITATION OF REMEDY AND LIABILITY:** SELLER SHALL NOT BE LIABLE FOR DAMAGES CAUSED BY DELAY IN PERFORMANCE. THE SOLE AND EXCLUSIVE REMEDY FOR BREACH OF WARRANTY HEREUNDER SHALL BE LIMITED TO REPAIR, CORRECTION, REPLACEMENT, OR REFUND OF PURCHASE PRICE UNDER THE LIMITED WARRANTY CLAUSE IN SECTION 1 HEREIN. IN NO EVENT, REGARDLESS OF THE FORM OF THE CLAIM OR CAUSE OF ACTION (WHETHER BASED IN CONTRACT, INFRINGEMENT, NEGLIGENCE, STRICT LIABILITY, OTHER TORT, OR OTHERWISE), SHALL SELLER'S LIABILITY TO BUYER AND/OR ITS CUSTOMERS EXCEED THE PRICE TO BUYER OF THE SPECIFIC GOODS MANUFACTURED OR SERVICES PROVIDED BY SELLER GIVING RISE TO THE CLAIM OR CAUSE OF ACTION. BUYER AGREES THAT IN NO EVENT SHALL SELLER'S LIABILITY TO BUYER AND/OR ITS CUSTOMERS EXTEND TO INCLUDE INCIDENTAL, CONSEQUENTIAL, OR PUNITIVE DAMAGES. THE TERM "CONSEQUENTIAL DAMAGES" SHALL INCLUDE, BUT NOT BE LIMITED TO, LOSS OF ANTICIPATED PROFITS, LOSS OF USE, LOSS OF REVENUE, AND COST OF CAPITAL.

## Safety messages

Observe all environmental and personal safety messages described in this document, warning labels on the device, and your company's operational safety requirements.

### **⚠ WARNING**

#### **Safety compliance**

The seller does not accept any responsibility for installations of this device or any attached equipment in which the installation or operation thereof has been performed in a manner that is negligent and/or non-compliant with applicable safety requirements.

Install and operate all equipment as designed and comply with all safety requirements.

If the device is not operated in a manner recommended by the manufacturer, the overall safety could be impaired.

### **⚠ WARNING**

#### **Supply mains connection**

Qualified personnel must connect the device to supply mains in accordance with local and national codes.

### **⚠ WARNING**

#### **Explosion**

Do not open when energized or when an explosive atmosphere is present.

Keep cover tight while circuits are live.

Use cables or wires suitable for the marked "T" ratings.

Cover joints must be cleaned before replacing the cover.

Ensure that conduit runs have a sealing fitting adjacent to the enclosure.

Use supply cables or wires suitable for at least 176 °F (80 °C).

### **⚠ WARNING**

#### **Electric shock**

Provide a suitable approved switch and fuse or circuit breaker between the power supply and the gas chromatograph (GC). Use the switch to disconnect power before performing maintenance on the equipment.

### **⚠ WARNING**

#### **Ventilation**

Use the device in a well-ventilated area.

If you plan to place the device in a sealed shelter, always vent it to atmosphere with 0.25-in. tubing or larger. This will prevent the build up of H<sub>2</sub> and sample gas.

### **⚠ WARNING**

#### **Leak testing**

Leak test each gas connection at installation.

### **⚠ WARNING**

#### **Toxic vapors**

Exit ports may discharge dangerous levels of toxic vapors.

Use proper protection equipment and a suitable exhaust device.

## ⚠ WARNING

### Burns

To prevent burns, do not touch any of the hot parts. All parts of an analyzer are always hot unless it has been switched off and allowed to cool down.

Before fitting, removing, or performing any maintenance on the analyzer, make sure that it has been switched off and allowed to cool for at least two hours.

When handling the analyzer, always use suitable protective gloves.

These precautions are particularly important when working at heights.

If burned, seek medical treatment immediately.

## ⚠ WARNING

Substitution of components may impair suitability for Class I, Division 1 and 2.

## ⚠ WARNING

### Safe atmosphere

Only use service connections when the atmosphere is known to be safe.

## ⚠ WARNING

**This device is heavy equipment. Two people are required to move the device.**

Failure to observe this warning may cause serious injury to personnel.

Observe all proper lifting methods as defined by your site operating procedures.

## ⚠ WARNING

Before converting carrier gas to hydrogen, review your local hazardous area requirements to ensure compliance.

## ⚠ WARNING

### Physical access

Unauthorized personnel may potentially cause significant damage to and/or misconfiguration of end users' equipment. This could be intentional or unintentional and needs to be protected against.

Physical security is an important part of any security program and fundamental to protecting your system. Restrict physical access by unauthorized personnel to protect end users' assets. This is true for all systems used within the facility.

## NOTICE

The analyzer electronics and oven assembly, when housed inside a purged enclosure, meet the certifications and classifications identified in the Specifications section of the Product Data Sheet, which is located on the Emerson website: [Emerson.com](https://www.emerson.com).

## Waste disposal



Do not dispose of measuring tools into household waste.

Only for EC countries:

In accordance with European Directive 2012/19/EU for Waste Electrical and Electronic Equipment and its implementation into national right, measuring tools that are no longer usable must be collected separately and disposed of in an environmentally correct manner.



# Contents

<b>Chapter 1</b>	<b>Cybersecurity recommendations for Rosemount XA gas chromatograph (GC) and MON2020 users.....</b>	<b>9</b>
<b>Chapter 2</b>	<b>About Rosemount 470XA Gas Chromatographs.....</b>	<b>11</b>
	2.1 Description.....	11
	2.2 Specifications.....	11
<b>Chapter 3</b>	<b>Equipment overview.....</b>	<b>15</b>
	3.1 Exterior.....	15
	3.2 Interior.....	19
<b>Chapter 4</b>	<b>Installation.....</b>	<b>21</b>
	4.1 Site requirements.....	21
	4.2 Actions upon receiving the gas chromatograph (GC).....	21
	4.3 Mounting the gas chromatograph (GC).....	23
	4.4 Mounting the sample conditioning system (SCS).....	31
	4.5 Secure the gas chromatograph (GC) to the mounting bracket.....	37
	4.6 Connect tubing.....	38
	4.7 Connect to the carrier gas.....	39
	4.8 Connect to actuation gas.....	40
	4.9 Connect to the calibration gas.....	40
	4.10 Connect to the sample gas.....	42
	4.11 Electrical connections.....	43
	4.12 Connecting to Ethernet ports.....	46
	4.13 Connecting to external devices.....	51
	4.14 Connecting to power.....	55
	4.15 Starting up and configuring the gas chromatograph (GC).....	57
<b>Chapter 5</b>	<b>Using the Rosemount 470XA.....</b>	<b>67</b>
	5.1 Connect a local computer to the Rosemount 470XA.....	67
	5.2 Interacting with the local operator interface (LOI).....	68
	5.3 Local operator interface (LOI) screen descriptions.....	71
	5.4 Common local operator interface (LOI) tasks.....	85
	5.5 Advanced configuration and operation topics.....	93
<b>Chapter 6</b>	<b>Preventative maintenance.....</b>	<b>101</b>
	6.1 Save diagnostic data.....	101
	6.2 Set up auto-calibration in software.....	101
	6.3 Display trend data.....	101
	6.4 Configure the valve timing.....	102
<b>Chapter 7</b>	<b>Replacing the Maintainable Module.....</b>	<b>103</b>
	7.1 Remove the Maintainable Module.....	103
	7.2 Install a Maintainable Module.....	107
<b>Chapter 8</b>	<b>Repairing and maintaining the valves.....</b>	<b>111</b>

	8.1 Required tools for valve maintenance.....	111
	8.2 Overhaul a valve.....	111
	8.3 Replace solenoids.....	113
<b>Chapter 9</b>	<b>Troubleshooting.....</b>	<b>117</b>
	9.1 Alarms.....	117
	9.2 Gas chromatograph (GC) won't power up.....	126
	9.3 Un-normalized total error.....	127
	9.4 Replace the central processing unit (CPU).....	128
	9.5 Recover the central processing unit (CPU).....	130
<b>Chapter 10</b>	<b>Spare parts.....</b>	<b>133</b>
<b>Appendix A</b>	<b>Pre-defined Modbus® map files.....</b>	<b>135</b>
<b>Appendix B</b>	<b>China RoHS table.....</b>	<b>137</b>



# 1 Cybersecurity recommendations for Rosemount XA gas chromatograph (GC) and MON2020 users

## **Install XA GC in a secure environment with physical protection**

- Install the XA GC in a secure environment with physical protection.
- Scan the USB shipped with the XA GC with anti-virus software before use.
- Store all the GC related files including application files, drawings, and documents, in a secure network/drive with restricted access.

## **Install MON2020 on a secure personal computer (PC)**

- Access to PC should be protected by adequate username/password.
- With restricted admin privileges on PC - operating system (OS) configuration, install software, etc.
- Restrict network ports and connection of mass storage devices/removable media.
- Resides on a private local area network (LAN) with firewall and network access control list configured for blocking illegitimate access.
- With anti-virus software kept current on PC.
- With Microsoft® Windows automatic updates enabled on PC.
- PC updated with Windows security patches.
- With physical access controls - locked room, key-card entry, etc.

## **Use XA GCs in secure network**

This product is designed to be used in an industrial environment with appropriate defense-in-depth security measures and compensating controls effective against cyber-attacks. This product is not designed to be connected directly to the Internet or Internet facing networks. Security measures should include, but are not limited to:

- Ethernet should be set up in a private LAN with firewall and network access control list configured for blocking illegitimate access.
- Network devices stored with physical access controls - physical locks, ID verification, etc.
- Network devices updated with all available security patches.
- Anti-virus software kept current on all computers in the network.
- Other industry best practices for secure network.

## **Control access to XA GC using password of sufficient complexity**

- The password length should be at least eight alphanumeric characters.
- All default users should be removed after XA GC commissioning or password upgrade to comply with the password complexity guidelines.
- Password policy level should be set after GC commissioning by accessing **Tools** → **Users** → **User Administration**.
- Use a unique password for each user.

- Avoid sharing passwords with other users.

#### **Control access to user profile for XA GC using admin password of sufficient complexity**

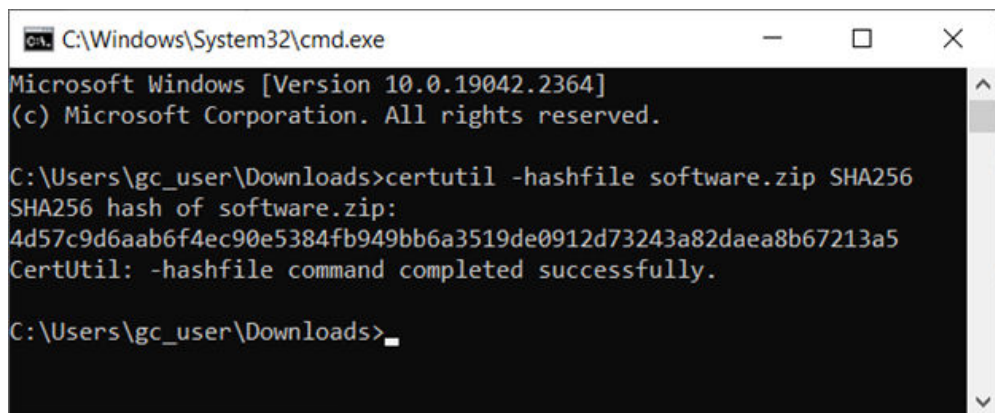
- The admin password length should be at least 10 alphanumeric characters.
- The admin password should include at least one number, mix of upper/lower case characters, and at least one special character (!@#\$%^&\* \_+=:?)
- The default admin password should be changed after GC commissioning by using the password complexity guidelines.
- Avoid sharing the password with non-admin users.

#### **Upload/download files of the approved types to/from XA GC**

- Upload/download files of the approved types to/from XA GC.
- The approved files of type include .xls, .xlsx, .pdf, .tif/.tiff, .xrted (XA trend file), .xcgm (XA chromatogram file), and .xcmp (XA comparison file).
- Scan the mass storage device with the latest anti-virus software before uploading any files to GC.

#### **Check integrity for distributed binaries**

- A hash value will be provided for some software/firmware files distributed by Emerson GC, so that the user can verify the integrity of the file.
- The hashing algorithm SHA-256 is used for calculating the hash value of the binary file.
- There are many programs for calculating the SHA-256 hash including Windows Command Prompt, Windows PowerShell, and third-party software (such as Hash Tool). The user can use a program of choice to calculate the SHA-256 hash value of the downloaded file and compare it to the value specified on the download page.
- The following is an example of using Windows Command Prompt to calculate the SHA-256 hash value:
  - In a command line, run the command:
    - `certutil -hashfile [filename] SHA256`
  - For example:



```
C:\Windows\System32\cmd.exe
Microsoft Windows [Version 10.0.19042.2364]
(c) Microsoft Corporation. All rights reserved.

C:\Users\gc_user\Downloads>certutil -hashfile software.zip SHA256
SHA256 hash of software.zip:
4d57c9d6aab6f4ec90e5384fb949bb6a3519de0912d73243a82daea8b67213a5
CertUtil: -hashfile command completed successfully.

C:\Users\gc_user\Downloads>
```

## 2 About Rosemount 470XA Gas Chromatographs

### 2.1 Description

The Rosemount 470XA Gas Chromatograph (GC) is part of the XA series of Emerson gas chromatographs. Designed to simplify natural gas measurement analysis, the 470XA provides greater ease of use and increased measurement performance for your C6+ BTU/CV analysis.

Another unique benefit of the 470XA is its Maintainable Module technology, which allows you to easily replace the GC module in the field in approximately two hours, including warm-up and purge, greatly reducing downtime and overall operating costs.

### 2.2 Specifications

**Table 2-1: Electronics specifications**

Specification	Description
Power supply	24 Vdc (standard) at the unit 21-30 Vdc (operating range) at the unit Class 2 and SELV as specified by CEC, C22.1, and NEC, National Fire Protection Association (NFPA)
	<div style="background-color: #0056b3; color: white; padding: 5px;"><b>NOTICE</b></div> Provide the gas chromatograph (GC) with one 5-amp circuit breaker for protection.
Power consumption at 72 °F (22 °C)	55 Watts (start-up) 25 Watts (steady state)

**Table 2-2: Construction specifications**

Specification	Description
Environmental temperature	-4 to +140 °F (-20 to +60 °C)
Enclosure protection rating	IP65 and Type 4X
Dimensions (without sample system or mounts)	18 in. (height) x 15.6 in. (width) x 11 in. (depth) 460 mm (height) x 396 mm (width) x 280 mm (depth)
Mounting options	Pipe, wall, or bench
Weight (without sample system or mounts)	50 lb. (23 kg)

**Table 2-3: Performance specifications**

Specification	Description
Applications	4-minute C6+ standard analysis <sup>(1)</sup>

**Table 2-3: Performance specifications (continued)**

Specification	Description
Repeatability	<p><b>Controlled environment</b></p> <ul style="list-style-type: none"> <li>±0.0125% calorific value</li> <li>±0.125 BTU/scf per 1,000 BTU/scf</li> </ul> <p><b>Uncontrolled environment: -4 to +140 °F (-20 to +60 °C)</b></p> <ul style="list-style-type: none"> <li>± 0.025% calorific value</li> <li>± 0.25 BTU/scf per 1,000 BTU/scf</li> </ul>
Calculations	International Organization for Standardization (ISO) 6976, American Gas Association (AGA) 8, Gas Processors Association (GPA) 2172 (using the GPA 2145 physical properties table)
Recommended carrier gas <ul style="list-style-type: none"> <li>Purity</li> <li>Moisture content</li> <li>Hydrocarbon content</li> <li>Supply pressure</li> <li>Carrier gas flow</li> </ul>	Zero-grade helium at 90 psig (6.2 barg) or hydrogen at 30 psig (2.1 barg) <ul style="list-style-type: none"> <li>99.995% (zero-grade)</li> <li>Less than 10 ppm</li> <li>Less than 0.5 ppm</li> <li>90 psig (6.2 barg) for helium; 60 psig (4.1 barg) for hydrogen</li> <li>20 cc/min for helium, 10 cc/min for hydrogen</li> </ul>
Recommended actuation gas <ul style="list-style-type: none"> <li>Moisture content</li> <li>Particulate</li> <li>Supply pressure</li> </ul>	Helium, nitrogen, or clean dry air at 90 psig (6.2 barg) <ul style="list-style-type: none"> <li>Less than 10 ppm</li> <li>Less than 2 microns</li> <li>90 psig (6.2 barg)</li> </ul>
Recommended sample (calibration) gas input pressure range	20 psig (1.4 barg)
Valves	Three 6-port diaphragm analytical valves
Oven	Airless iso-thermal
Detector	Thermal conductivity detector (TCD)
Streams	Up to 3 sample streams and 1 calibration stream
Vibration	Meets ASTM-4169 specifications

(1) Custom light process applications available upon request.

**Table 2-4: Standard communications**

Specification	Description
Ethernet	Two available connections: one RJ-45 plug-in port and one 4-wire termination. Both with 10/100 mbps.
Analog input	One standard input filtered with transient protection, 4–20 mA that is user scalable and assignable.
Analog outputs	Two isolated outputs, 4–20 mA.
Digital inputs	One input that is user assignable, optically isolated, and rated to 30 Vdc at 0.5 A.
Digital output	One user-assignable output, Form C and electro-mechanically isolated, 24 Vdc.
Serial ports	Two termination blocks, configurable as RS-232 or RS-485.

**Table 2-5: Archived data storage capabilities**

Type <sup>(1)</sup>	Maximum number of records	Remarks
Analysis results	86464	240 days with 4-minute cycle time
Final calibration results	370	1 year of final calibration results
Calibration results	100	
Final validation results	370	1 year of final validation results
Validation results	100	
Analysis chromatogram	3406	Approximately 9.4 days assuming 4-minute cycle time
Final calibration chromatograms	370	1 year of final calibration chromatograms <sup>(2)</sup>
Final validation chromatograms	370	1 year of final validation chromatograms <sup>(2)</sup>
Protected chromatograms	100	User-selectable
Hourly averages (up to 250 variables) <sup>(3)</sup>	250	10.4 days
Daily averages (up to 250 variables) <sup>(3)</sup>	365	1 year
Weekly averages (up to 250 variables) <sup>(3)</sup>	58	1 year
Monthly averages (up to 250 variables) <sup>(3)</sup>	12	1 year
Variable averages (up to 250 variables) <sup>(3)</sup>	250	
Every run (up to 250 variables) <sup>(3)</sup>	250	
Alarm logs	1000	
Event logs	1000	

(1) Based on four-minute BTU with daily calibration application.

(2) The gas chromatograph (GC) can store final calibration or final validation chromatograms for up to a year, provided that no more than one calibration or validation is run per day, and the cycle time is less than 15 minutes. If the cycle time exceeds 15 minutes, the oldest final calibration or validation chromatograms are deleted to make room for newer ones.

(3) You can have a total of up to 250 averages of all types, including hourly, 24 hour, weekly, monthly, variable, and every run averages.

**Table 2-6: Maximum approved gas pressure**

Gas stream	Maximum approved pressure
Sample/calibration	30 psig (2.1 barg)
Carrier	90 psig (6.2 barg)
Actuation	110 psig (7.6 barg)

### Vent specifications

The flows of the vents are:

- Sample vent: 10 to 50 cc/min of sample gas for approximately 3.5 minutes of the four-minute cycle.

- Measure vent: Continuous flow of less than 20 cc/min of carrier gas and 20 cc of sample gas per analysis cycle.
- Sample bypass: Continuous flow of 150 to 200 cc/min of sample gas.

**Product certifications**

For product certifications, see the [Rosemount 470XA Gas Chromatograph Quick Start Guide](#).

## 3 Equipment overview

### 3.1 Exterior

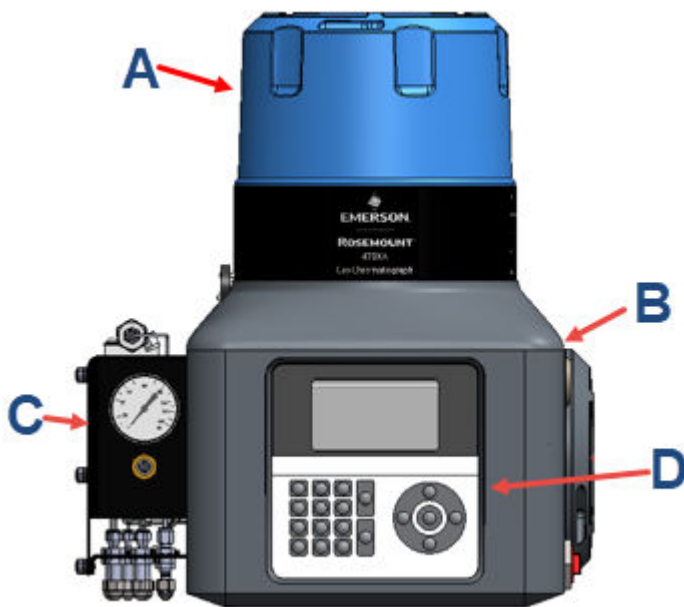
#### NOTICE

Lower cable entry: This is the most convenient entry point for connecting cables to the Ethernet port, communications ports, and external device terminals. If not using this entry for cables, use a certified conduit plug. See [Table 3-1](#).

**Table 3-1: Certified conduit plugs**

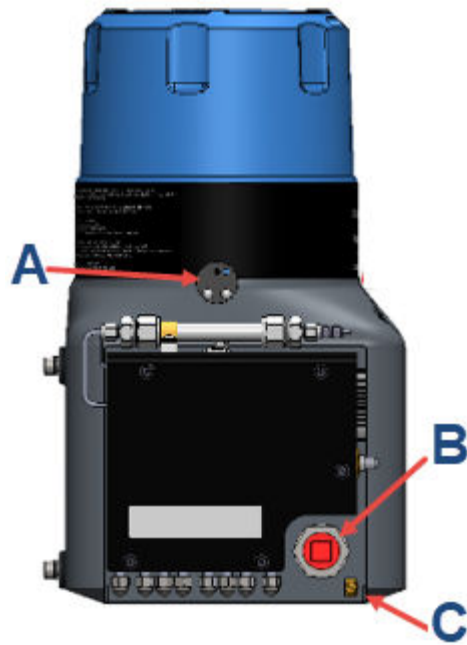
Certification type	Additionally supplied certified parts
CSA	M32 to ¾-in. adapter and a ¾-in. sealing plug
ATEX/IECEX	M32 plug

**Figure 3-1: Front view**



- A. Upper housing (dome)
- B. Lower housing
- C. Flow panel
- D. Local operator interface (LOI)

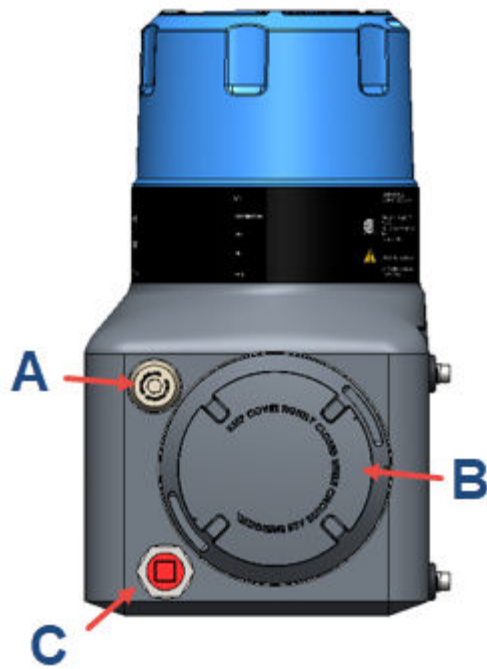
Figure 3-2: Left side view



- A. Locking bolt
- B. Cable entry
- C. Ground lug

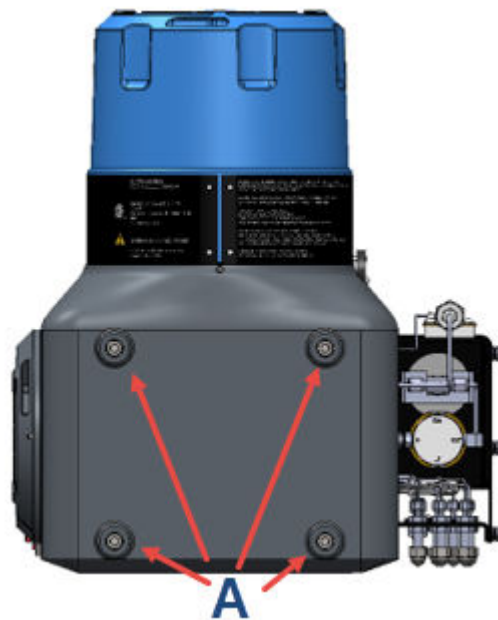


Figure 3-3: Right side view



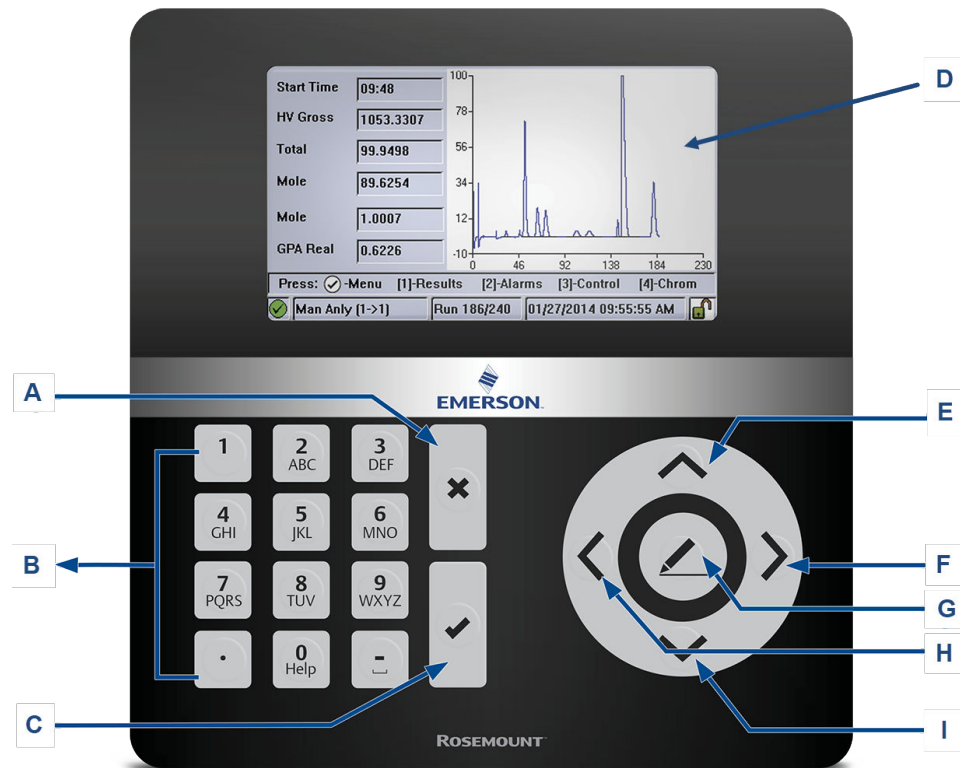
- A. Upper cable entry
- B. Port hole
- C. Lower cable entry

Figure 3-4: Rear view



- A. Mounting bolts

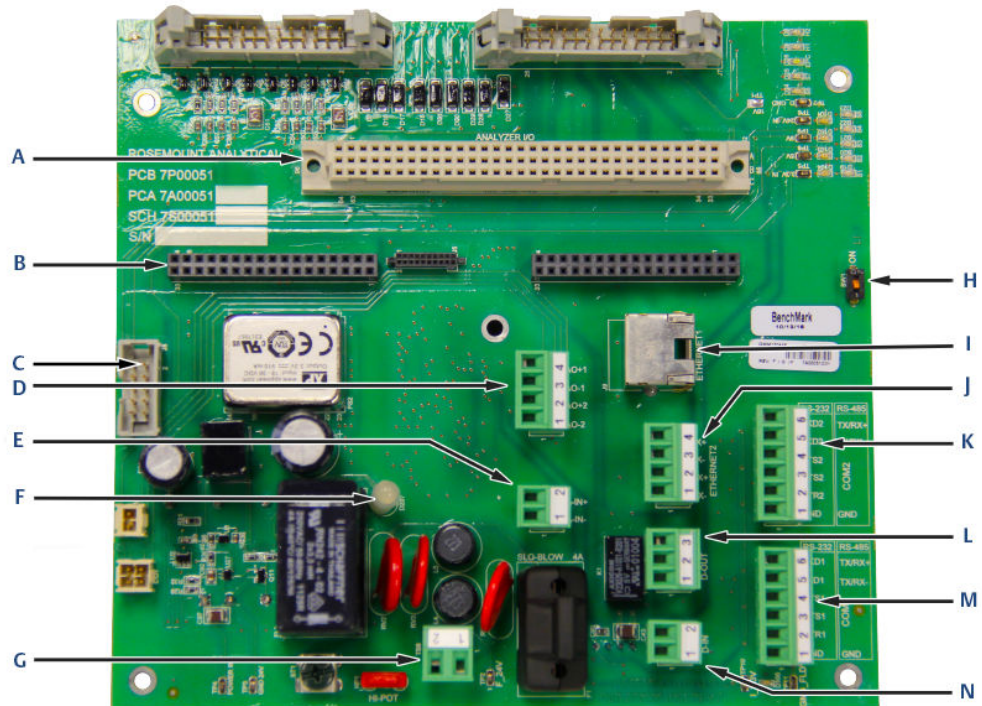
Figure 3-5: Local operator interface (LOI)



- A. Exit/cancel
- B. Alphanumeric keypad
- C. Enter
- D. Full color screen: 480 x 272 pixels
- E. Up
- F. Right
- G. Select/edit
- H. Left
- I. Down

## 3.2 Interior

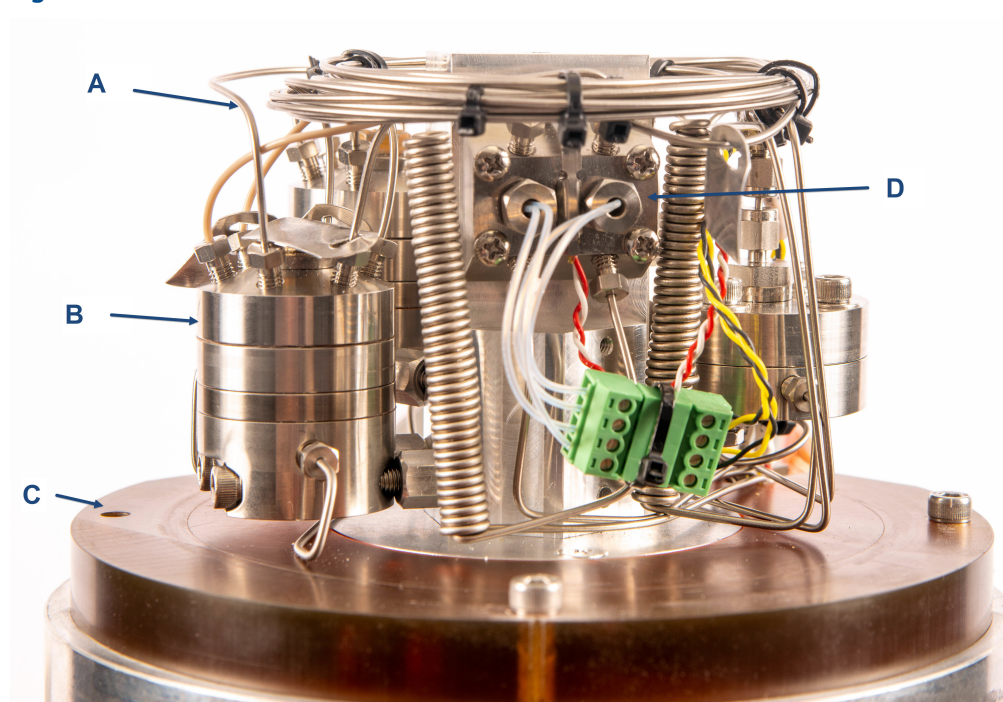
Figure 3-6: Backplane board



- A. ANA: Analyzer board
- B. CPU: Central processing unit board
- C. J8: Local operator interface (LOI) connector
- D. TB10: Analog outputs (two)
- E. TB2: Analog input
- F. LED: LED light<sup>(1)</sup>
- G. TB8: 24 Vdc power
- H. SW1: DHCP switch
- I. RJ45: Plug-in Ethernet port
- J. TB5: Wired Ethernet port
- K. TB9: Communication 2 port
- L. TB3: Digital output
- M. TB4: Communication 1 port
- N. TB1: Digital input

<sup>(1)</sup> The LED light is always on for illumination purposes only.

Figure 3-7: Maintainable Module



- A. *Chromatography columns*  
Separates the sample gas into its component compounds so that they can be detected and measured. The gas chromatograph's (GC's) pre-coiled, micro-packed columns contain active materials that selectively impede the flow of individual component compounds based on their boiling point, so that components with lower boiling points take longer to travel through the columns than components with higher boiling points. The GC uses four chromatography columns and a single restrictor column.
- B. *Analytical valves*  
Manipulate the flow of carrier and sample gases through the columns and the detector. The analytical valves use diaphragm-actuated pistons to block or release the flow of the gases between adjacent ports on the valve. The majority of maintenance on the Maintainable Module involves replacing the diaphragms and cleaning the sealing surfaces of the analytical valves.
- C. *Module base plate*  
Most of the components of the analytical module are mounted to the upper and lower surface of the module base plate.
- D. *Thermal conductivity detectors (TCDs)*. A single TCD has two thermistors that respond to the difference in thermal conductivity between the carrier gas and the separated components.

**Not shown:**

**Heater cap** Controls the thermal environment surrounding the analytical components of the module, which is crucial to ensure reliable and repeatable analysis.

## 4 Installation

### 4.1 Site requirements

Consider the following when choosing an installation site for the gas chromatograph (GC):

- This GC is designed to operate at temperatures between -4 and +140 °F (-20 and +60 °C).
- Install the GC as close as possible to the sample point, but allow for adequate access for maintenance tasks and adjustments. Also, install the GC in a way that allows easy access and viewing of the local operator interface (LOI).
- Allow at least 10 in. (254 mm) on the right and left sides of the GC to permit access to the side portal holes where the field terminations are made.
- Allow a minimum of 10 in. (254 mm) above the top of the dome to facilitate access to the analytical module.

### 4.2 Actions upon receiving the gas chromatograph (GC)

#### 4.2.1 Unpacking

##### **⚠ WARNING**

**This device is heavy equipment. Two people are required to move the device.**

Failure to observe this warning may cause serious injury to personnel.

Observe all proper lifting methods as defined by your site operating procedures.

---

The device weighs 50 lb. (23 kg) without the sample system. Carefully open and remove the device from the packing crate. If necessary, ask for assistance.

Figure 4-1: Rosemount 470XA



A. Not a lift point

## NOTICE

Equipment damage  
Lifting the device by the flow panel may cause damage to the equipment.

### 4.2.2 Inspect and verify received equipment

Check the equipment against the packing slip to see if the shipment is complete.

Inspect the equipment for damage that may have been incurred during shipment. If any parts or assemblies appear to have been damaged:

#### Procedure

1. File a claim with the carrier.
2. Take photos of the damaged area(s).
3. Contact your local Emerson sales representative.

## 4.3 Mounting the gas chromatograph (GC)

You can install the Rosemount 470XA using one of the following options:

- Wall mount
- Pole mount

---

#### Note

Remove the caps from the atmospheric vent before mounting the GC.

---

Check the packing slip or the GC's sales order to learn which mounting hardware was selected for it.

---

#### Note

All options require the same mounting bracket, but use different hardware to mount it.

---

The pole or wall must be able to support at least 50 lb (23 kg) and withstand the forces applied when performing routine maintenance, such as removing the oven enclosure dome.

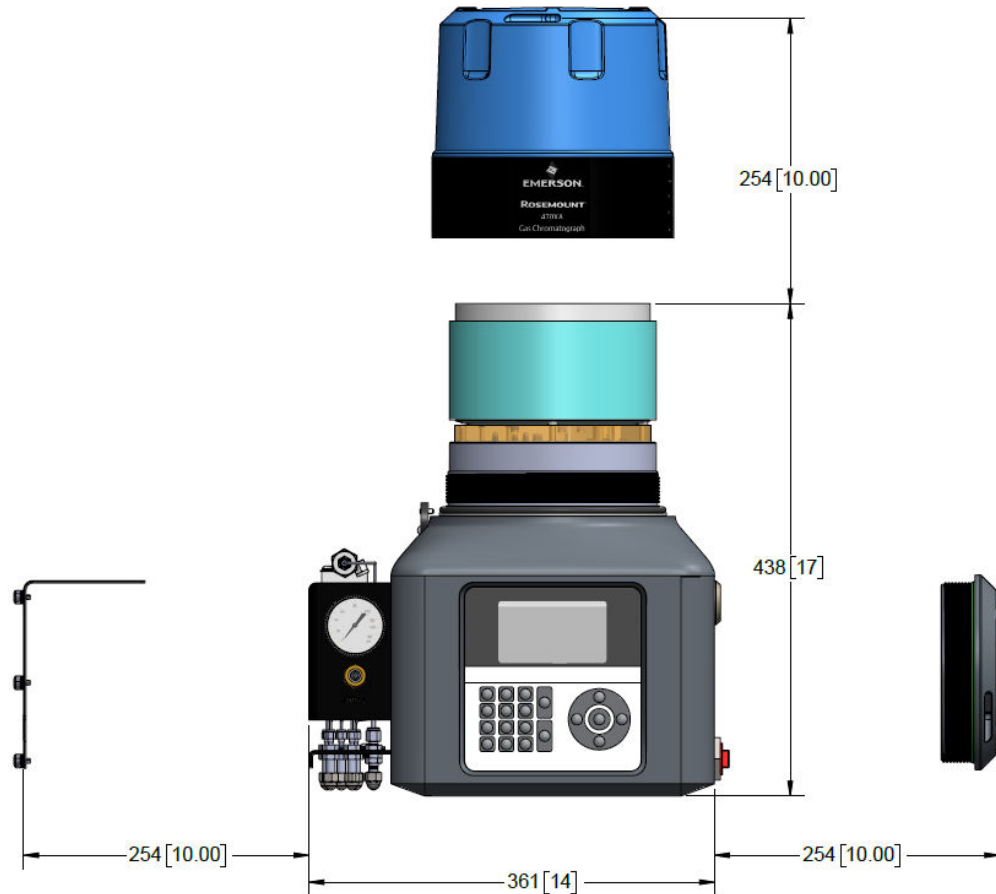
### NOTICE

When putting a GC into its final position, be careful to avoid damaging any of the external components or their attachments. Also, make sure you understand the installation procedure before handling the GC and collect the appropriate tools beforehand.

---

### 4.3.1 Dimensions

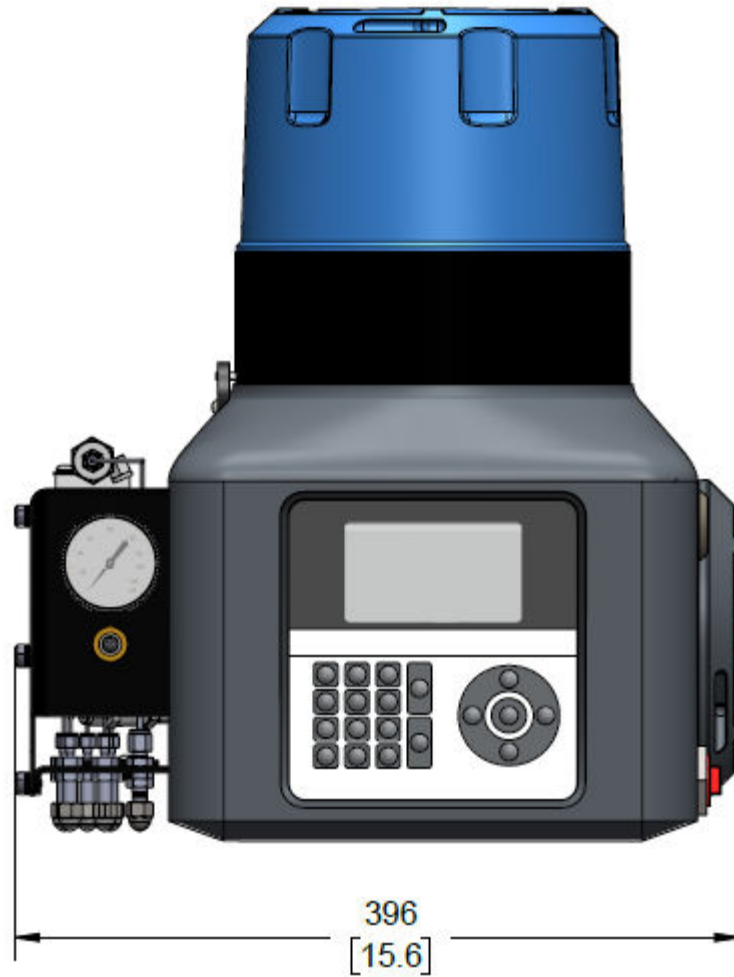
Figure 4-2: Rosemount 470XA dimensions



Dimensions are in millimeters with inches in brackets.



Figure 4-3: 470XA dimensions collapsed

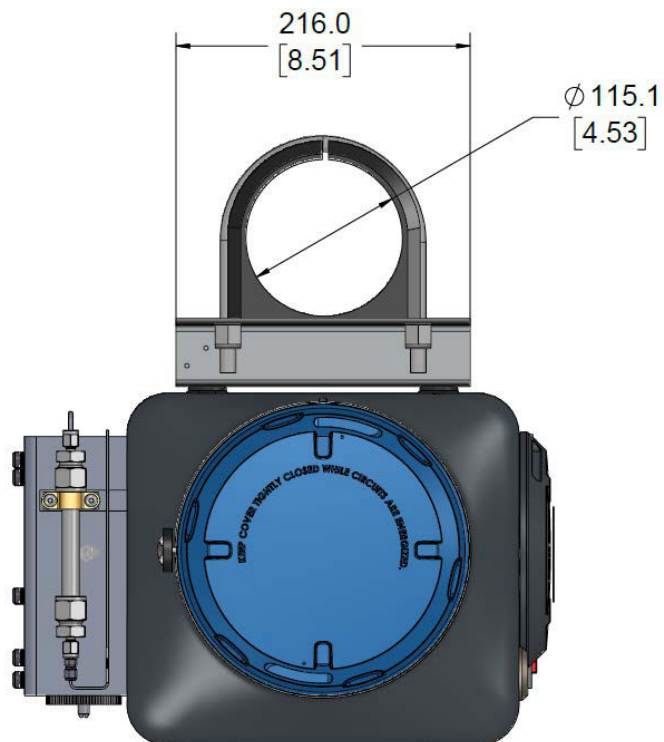


Dimensions are in millimeters with inches in brackets.

## 4.3.2 Pole mounting

The pole mount arrangement uses a pair of U-shaped pipe clamps and a mounting bracket to attach the gas chromatograph (GC) to a pole that is 4 in. (101.6 mm) in diameter.

**Figure 4-4: Pole and floor stand mounting dimensions**



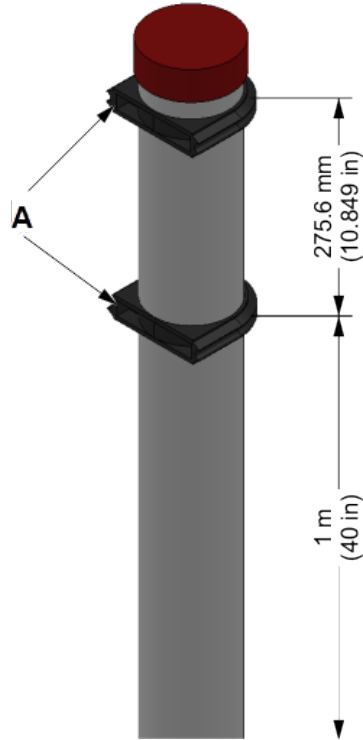
Dimensions are in millimeters with inches in brackets..

### Mount the gas chromatograph (GC) to a pole

#### Procedure

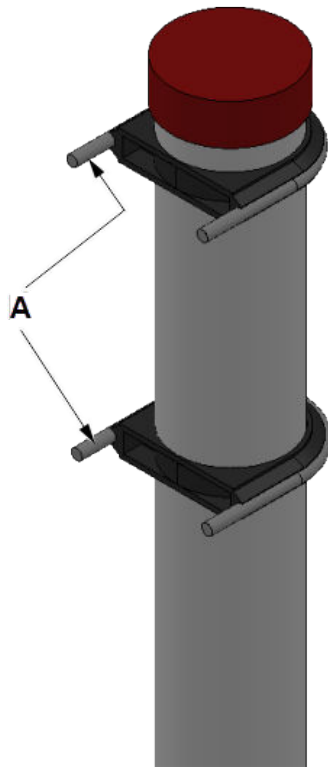
1. Anchor the pole mount base to the foundation with a 4½-in. or ¾-in. cement anchor.

- Slide the U-bolt plastic inserts onto the pole and place the lower clamp approximately 40 in. (1 m) from the ground and the upper clamp 10¾-in. (275.6 mm) above the lower clamp.



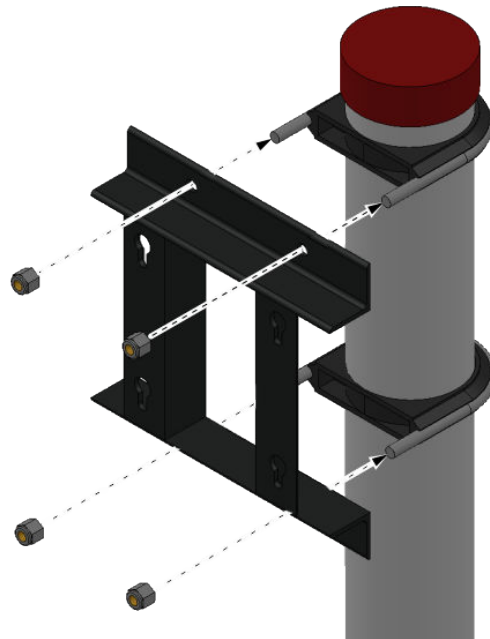
A. U-bolt plastic inserts

- Slide the two U-bolts into the plastic inserts.



A. U-bolts

- Attach the mounting bracket to the pole by matching the bracket's mounting holes to the prongs of the pipe clamps.



- Tighten the nuts onto the prongs.

The mounting bracket should be firmly attached to the pole.

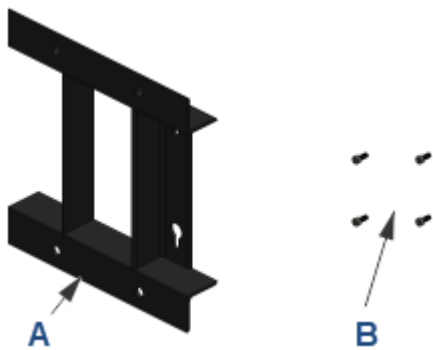
**Related information**

[Secure the gas chromatograph \(GC\) to the mounting bracket](#)

### 4.3.3 Wall mounting

---

**Figure 4-5: Wall mount bracket parts**



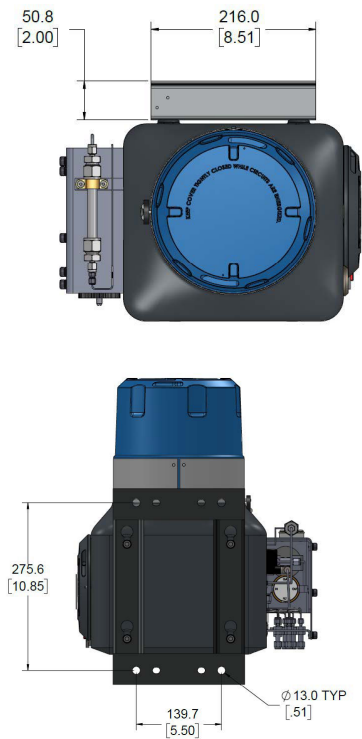
- A. Mounting bracket
  - B. Four M8 x 1.25 x 18 mounting bolts with washers
- 

**Note**

You will also need four 3/8-in. (10 mm) threaded wall anchors that are capable of supporting at least 50 lb. (23 kg). Wall anchors are not included in the mounting kit.

---

**Figure 4-6: Wall mounting dimensions**



Dimensions are in millimeters with inches in brackets.

## Mount the bracket to a wall

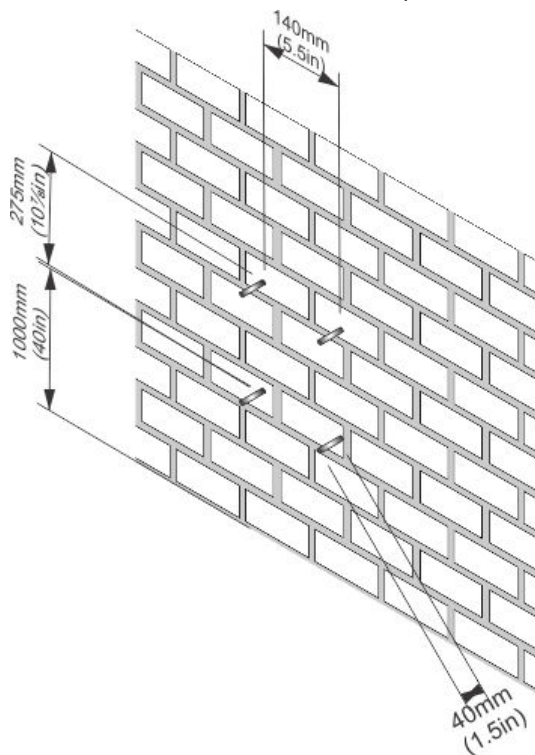
### Prerequisites

The wall must be able to hold approximately 50 lb. (23 kg).

### Procedure

1. Install four threaded wall anchors according to the dimensions of the gas chromatograph (GC). Use the bracket as a guide to locate the anchors correctly before drilling the holes.

The threads of the anchors should protrude from the wall by 1½ in. (40 mm).



2. Place the mounting bracket on to the wall anchors and tighten the mounting nuts. Ensure that the bracket is attached firmly to the wall.

### Related information

[Secure the gas chromatograph \(GC\) to the mounting bracket](#)

## 4.4 Mounting the sample conditioning system (SCS)

There are several sample conditioning systems (SCS) available for the 470XA Gas Chromatograph (GC).

For multiple stream applications, several plate-mounted options are available that can be mounted to a pole or wall.

It is also possible to use a third-party SCS. A third-party SCS must contain the following functional components:

- 2-micron or better particulate filter
- Liquid filter/shut-off
- Flow control to limit the sample flow to between 20 and 50 cc/min

## 4.4.1 Mount a single stream sample conditioning system (SCS) to the gas chromatograph (GC)

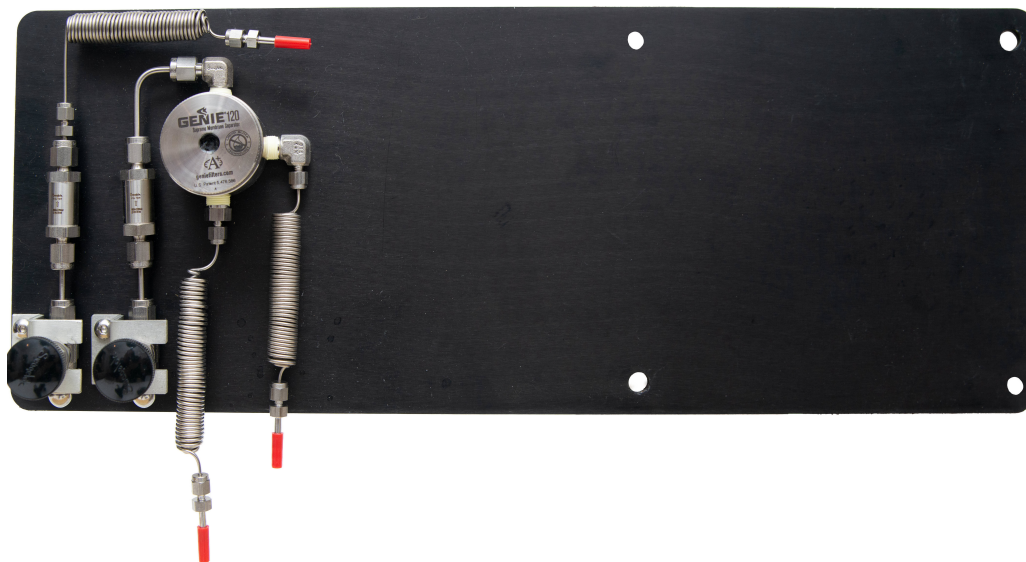
---

### Note

Mount the SCS to the GC before mounting the GC to a wall or pole.

---

**Figure 4-7: Sample conditioning system**



---

### Prerequisites

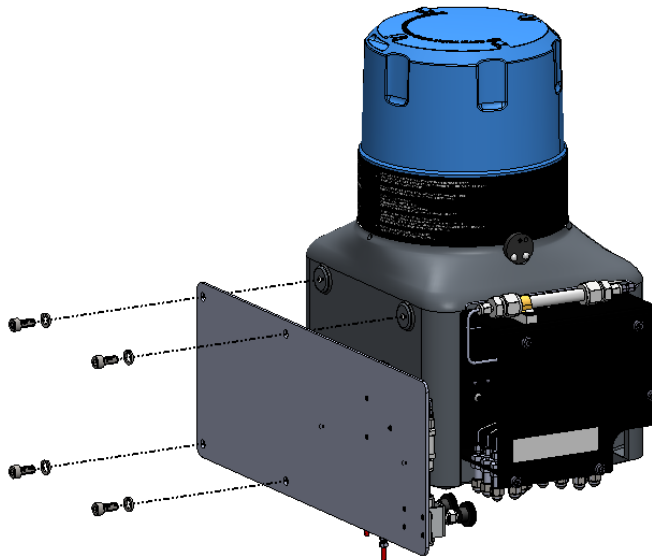
Make sure the mounting bracket is mounted to the wall or pole before beginning this procedure.



**Procedure**

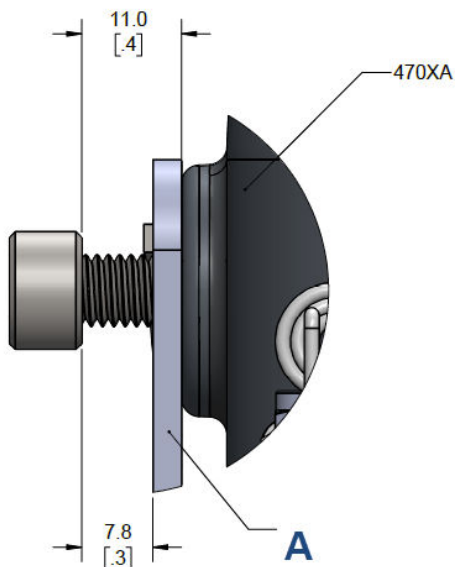
1. Use the four M8 x 1.25 x 18 mounting bolts (included with the SCS) to secure the SCS to the back of the GC.

**Figure 4-8: Securing SCS to GC**



Leave about .3 in. (7.8 mm) between the SCS and each washer.

**Figure 4-9: Mounting bolt dimensions**



Dimensions are in millimeters with inches in brackets.

A. SCS

2. Mount the GC to the bracket, so that the SCS is between the back of the GC and the bracket.

**Figure 4-10: SCS mounted to the GC and bracket**

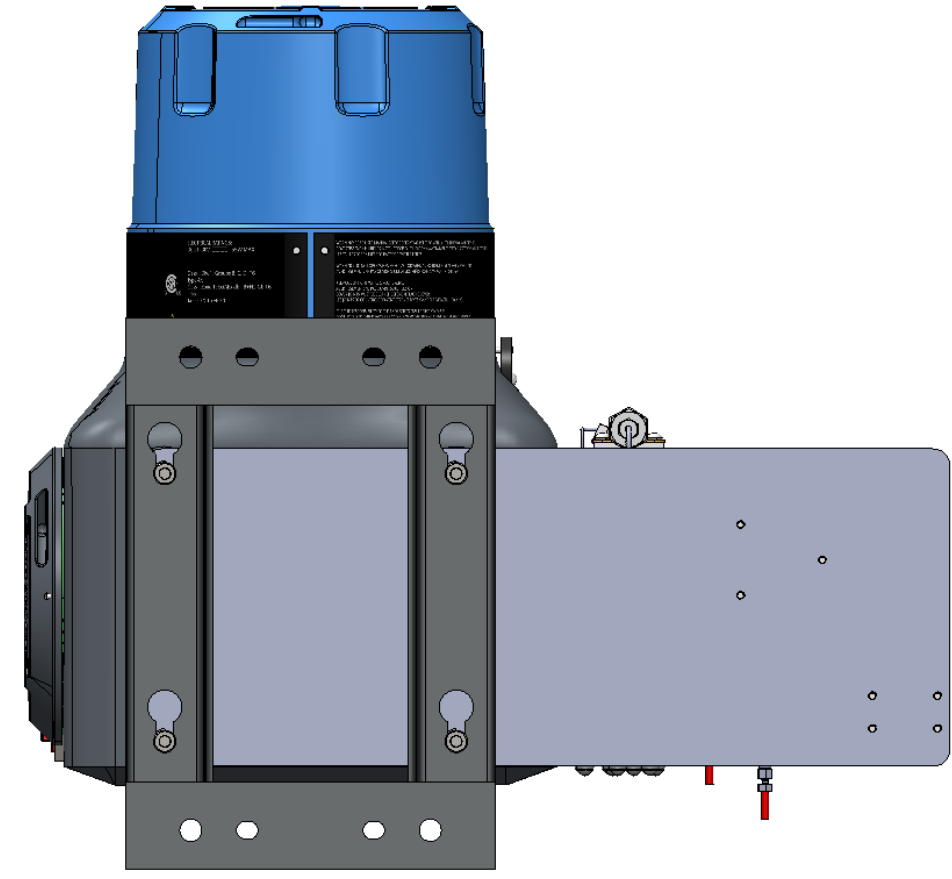


Figure 4-11: SCS mounted to the side of the GC

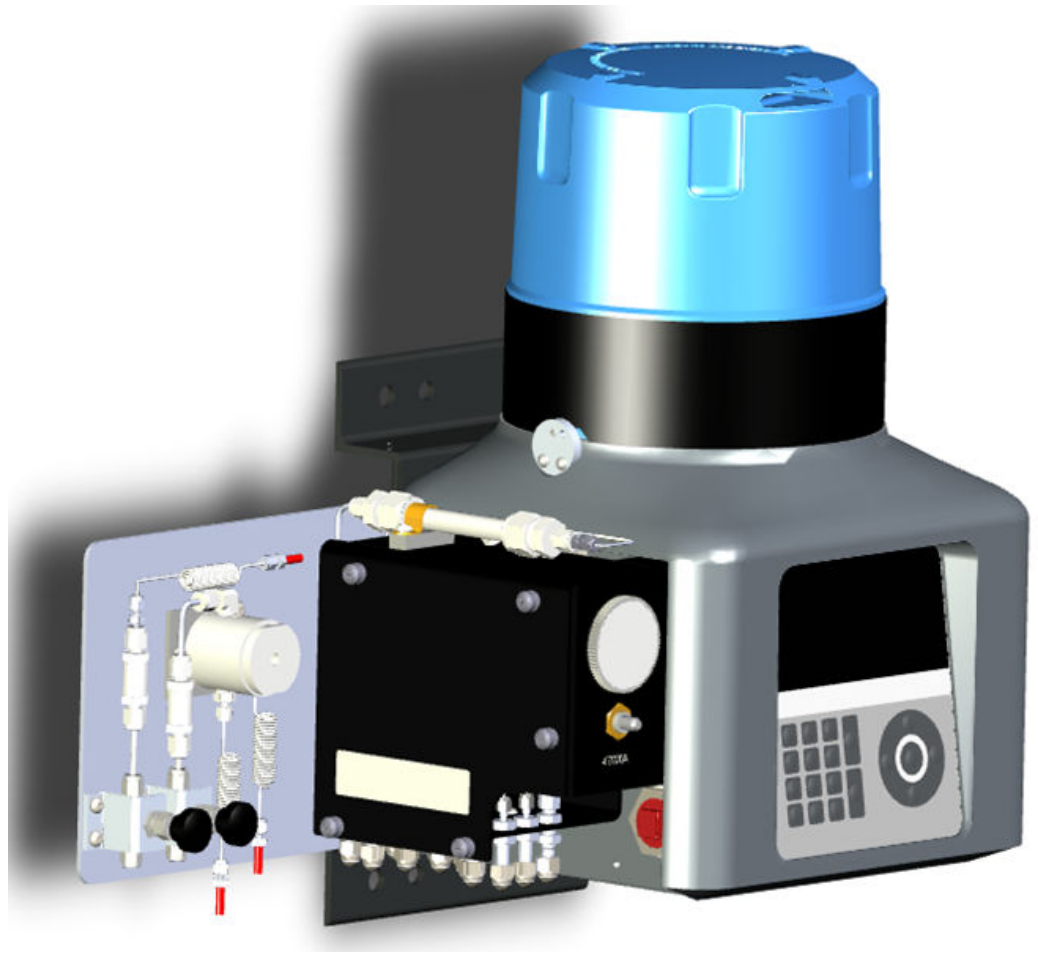
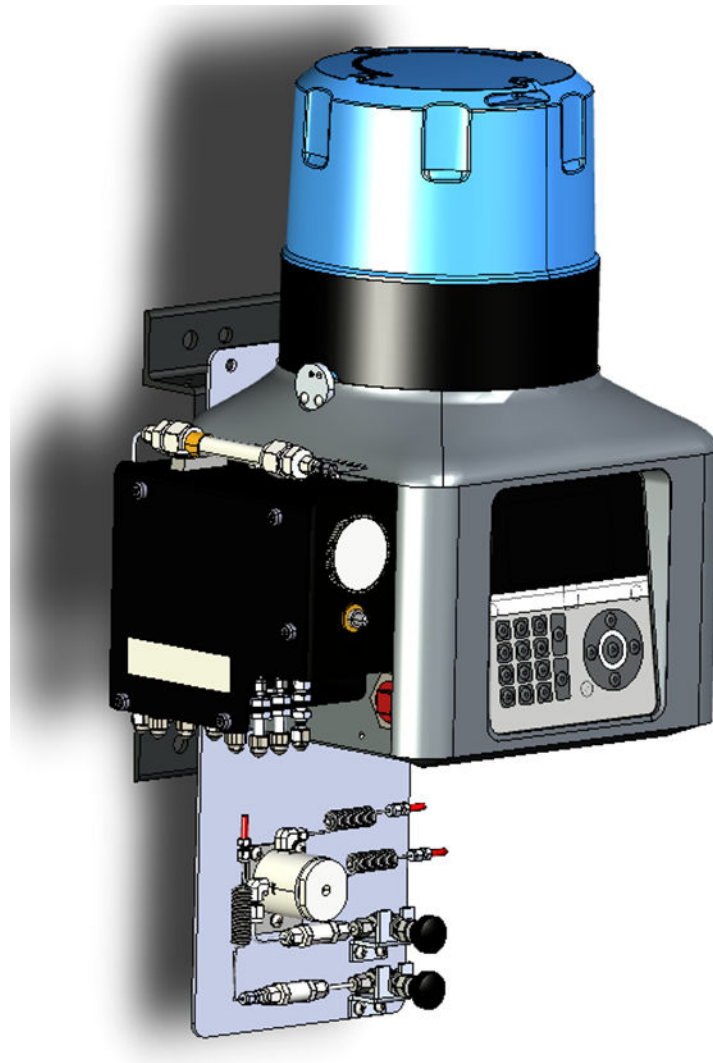


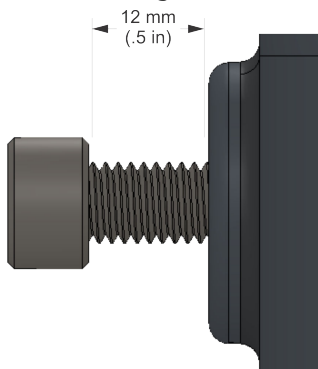
Figure 4-12: SCS mounted to the bottom of the GC



## 4.5 Secure the gas chromatograph (GC) to the mounting bracket

### Procedure

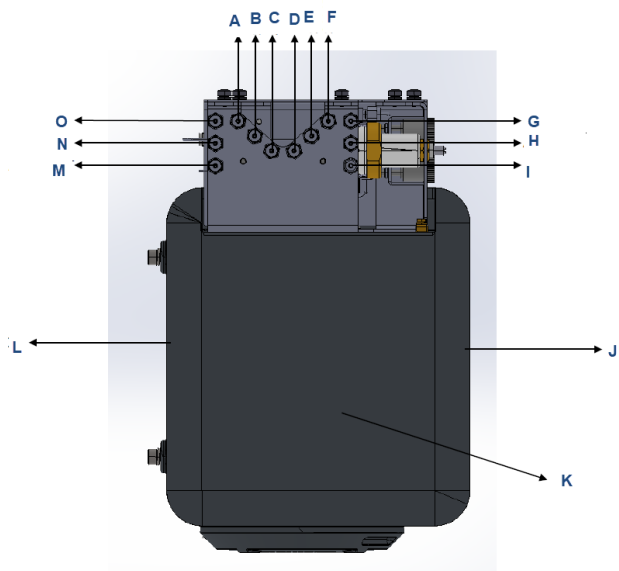
1. Screw two bolts, without the washers, into the top mounting holes on the back of the GC, leaving  $\frac{1}{2}$  in. (12 mm) of the thread exposed.



2. Maneuver the GC to insert the two top bolts into the eyelets of the mounting bracket and allow the bolts to drop down and hold the GC loosely on the bracket.
3. Screw in the two bottom bolts through the mounting bracket with the washers on. The flat washer should be against the bracket, and the spring washer between the flat washer and the bolt head. Tighten these two bolts by hand so that they secure the GC in place.
4. One at a time, remove the top bolts, put on the washers, and screw the bolts into the back of the GC and hand tighten.

## 4.6 Connect tubing

Figure 4-13: Tubing and vents



- A. Measure vent
- B. Sample vent
- C. Actuation vent
- D. Sample 1
- E. Sample 2
- F. Sample 3
- G. Calibration/sample gas connection
- H. Actuation gas connection
- I. Carrier gas connection
- J. Front
- K. Bottom
- L. Back
- M. Atmospheric vent
- N. Vent 2
- O. Vent 1

### Procedure

1. Remove the side cover of the flow panel by loosening the five captive screws.
2. Connect the sample stream(s) and the carrier, actuation, and calibration gases to the gas chromatograph's (GC's) bulkhead fittings.
3. Connect the atmospheric vents to a vent line of at least  $\frac{3}{8}$ -in. (9.3 mm) diameter, which will route the gas to the atmosphere in a safe area to ensure there is no back-pressure on the vents.

## 4.7 Connect to the carrier gas

Table 4-1: Carrier gas specifications

Carrier gas	Helium or hydrogen
Purity	99.995% (zero-grade)
Moisture content	Less than 10 ppm
Hydrocarbon content	Less than 0.5 ppm
Carrier supply pressure	90 psig (6.2 barg) for helium 30 psig (2.1 barg) for hydrogen
Carrier gas flow	Approx. 10 cc/min

### Procedure

1. To ensure the continuous operation of the analyzer, install two high pressure carrier gas cylinders and connect them to the gas chromatograph (GC) through a manifold arrangement that permits the replacement of empty cylinders without disrupting the operation of the analyzer.

The manifold arrangement can be a manual valve arrangement or a commercially available auto switch-over dual regulator assembly.

2. Using a two-stage bottle regulator with stainless steel diaphragms, regulate the carrier gas from the bottle pressure.

### **⚠ WARNING**

High pressures may damage the analyzer and cause an unsafe environment.

If using helium, regulate the carrier gas to 90 psig (6.2 barg).

If using hydrogen, regulate the carrier gas to 60 psig (4.1 barg).

Use a dual-stage regulator to ensure the outlet pressure will not change with changes in the bottle pressure. Use stainless steel diaphragms to avoid contaminating the analytical oven.

3. Use 1/8-in. stainless steel tubing that is clean and free of grease to connect from the carrier gas bottle manifold to the side sample panel carrier input fitting.
4. Before making the final connection to the sample system, blow through the external lines with helium for 30 seconds to remove any contamination, such as water or metal shavings, from cutting the tube.

### **NOTICE**

Only blow out the external lines on the sample handling system. Blowing out the interior GC lines may damage equipment.

## 4.8 Connect to actuation gas

The analytical valves require actuation gas to operate. When helium is used as a carrier gas, the default configuration is to also use helium as the actuation gas.

**Table 4-2: Actuation gas specifications**

Moisture content	Less than 10 ppm
Particulate	Less than 2 microns
Supply pressure	90 psig (6.2 barg)

### NOTICE

If you intend to use locally generated instrument air, ensure that the pressure is sufficient and use filters and dryers to ensure the actuation gas will meet the preceding specifications in order to avoid excessive maintenance.

### 4.8.1 Helium actuation gas

When using the carrier gas as the actuation gas, tee the actuation gas supply connection from the helium supply after the carrier drier.

### 4.8.2 Alternative actuation gas

If a gas other than the carrier gas is to be used as the actuation gas, connect the supply directly to the actuation gas port on the gas chromatograph's (GC's) gas manifold.

Use nitrogen, dry air, or some other non-hazardous gas as the actuation gas.

### ⚠ WARNING

Do not use hydrogen as actuation gas.

## 4.9 Connect to the calibration gas

The gas chromatograph (GC) requires a high quality, certified calibration gas to ensure accurate analysis. Although the Rosemount 470XA is typically set for an automatic daily calibration run in custody transfer applications, you can use MON2020 to configure calibrations for any time frequency or set it to manual calibration only.

### Prerequisites

The calibration gas must contain each component that you want to measure, ideally near the center of the expected range of the sample gas component. To ensure that all of the components in the calibration gas remain in the gas phase and that the composition remains consistent, install a calibration bottle heater blanket and use insulated or heat-traced stainless steel tubing between the calibration gas and the GC.

Table 4-3 lists the recommended ideal component concentrations for a calibration gas that can be used with most common natural gas applications.



**Table 4-3: Ideal calibration gas component concentrations**

Component	Recommended concentration
Methane	89.57%
Ethane	5.0%
Propane	1.0%
i-butane	0.3%
n-butane	0.3%
2.2 dimethyl butane	0.015%
neo-pentane	0.1%
iso-pentane	0.1%
n-pentane	0.1%
n-hexane	0.015%
Nitrogen	2.5%
Carbon dioxide	1.0%

When dimethyl butane (2.2 concentration) is present, add it to the n-hexane concentration in the C6+ calibration concentration.

**Procedure**

1. Regulate the calibration gas from bottle pressure to 20 psig (1.4 barg) using a two-stage bottle regulator with stainless steel diaphragms.  
Use a dual-stage regulator to ensure the outlet pressure will not change with changes in the bottle pressure. Use stainless steel diaphragms to avoid contamination.
2. Use 1/8-in. stainless steel tubing that is clean and free of grease to connect from the calibration gas bottle regulator to the calibration gas inlet connection on the sample conditioning system (SCS).
3. Before making the final connection to the SCS, blow through the lines for 30 seconds to remove any contamination, such as water or metal shavings, from cutting the tube.

**⚠ WARNING**

**High pressure**

High pressure may damage the analyzer and cause an unsafe condition.  
Do not allow the calibration gas pressure to rise above 30 psig (2.1 barg).

**NOTICE**

Only blow out the external lines on the sample handling system.  
Blowing out the interior GC lines may damage equipment.

## 4.10 Connect to the sample gas

The sample conditioning system controls how the gas sample is extracted, conditioned, and transported to the analyzer and is critical to the accurate and reliable performance of any gas chromatograph (GC).

The basic principles of sample conditioning are as follows:

- Take a representative vapor sample.
- Control the pressure and temperature without causing components to condense.
- Remove particulate and liquid contaminants.
- Transport the sample to the GC while maintaining the composition.

In the typical natural gas application, any liquid or solid contamination in the gas tends to accumulate on the inside pipe walls, even if it is clean and dry gas.

Observe the following guidelines for installing sample lines:

- Line length  
If possible, avoid long sample lines. In case of a long sample line, you can increase flow velocity by increasing the sample pressure and by using bypass flow via a speed loop.
- Sample line tubing material  
Ensure tubing is clean and free of grease.
- Dryers and filters
  - Use small sizes to minimize time lag and prevent back diffusion.
  - Install a minimum of one filter to remove solid particles. Most applications require fine-element filters upstream of the GC. The recommended sampling system includes a 2-micron filter.
  - Use ceramic or porous metallic type filters. Do not use cork or felt filters.

---

### Note

Install the probe/regulator first, immediately followed by the coalescing filter and then the membrane filter.

---

- Pressure regulators and flow controllers
  - Use stainless steel wetted materials.
  - Make sure regulators and controllers are rated for sample pressure and temperature.
- Pipe threads and dressings  
Use PTFE tape. Do not use pipe thread compounds (dope).
- Valving
  - Install a block valve downstream of sample takeoff point for maintenance and shutdown.
  - The block valve should be needle valve or cock valve type, of proper material and packing, and rated for process line pressure.

### Procedure

1. To take a representative sample of the flowing gas, insert a sample probe into the center third of the pipeline.

A major flow disturbance in the pipe, such as an elbow fitting or an orifice fitting, causes the contaminants to be temporarily mixed with the flowing gas stream; therefore, if practical, place the probe greater than five pipe diameters from such a

flow disturbance to reduce the amount of contaminants that may be extracted with the gas sample.

2. Once the sample is extracted, pass the gas through both particulate and liquid filters to remove any remaining contaminants before it enters the GC.
3. The sample pressure entering the GC's sample conditioning system should be between 15 and 30 psig (1 and 2.1 barg). If the pressure in the pipeline is higher than this, regulate the sample pressure to this pressure with a dual stage regulator. Regulate pressure immediately after the probe or combine it with the probe (a regulator probe), because any extended lengths of sample line before the pressure regulator add significant lag time, which is the time taken for the sample entering the probe to reach the analyzer oven.

---

#### Note

When the pressure of a gas is reduced, the temperature of the gas decreases. If you reduce the temperature below the sample's hydrocarbon dew point, the heavier hydrocarbons begin to condense and be removed from the gas phase, which changes the composition of the gas. The analyzed sample no longer accurately represents the flowing gas stream.

---

4. To avoid this hydrocarbon condensation, heat the regulator and sample lines to the GC to at least 30 °F (17 °C) above the expected temperature of the flowing gas stream.
5. Use stainless steel tubing and fittings for all of the sample lines.  
Use PTFE tape when making threaded connections in the sample system. Do not use pipe thread compounds.
6. Once the sample is extracted, pass the gas through both a 2-micron particulate filter and a liquid filter/shut-off to remove any remaining contaminants before it enters the GC.

#### NOTICE

##### Equipment damage

If the sample system does not contain a 2-micron filter and a liquid filter/shut-off, the GC's warranty may be void if it is determined the failure is due to contamination.

All sample conditioning systems sold with the Rosemount 470XA include a 2-micron filter for each stream; customers can also purchase a liquid filter/shut-off separately for each stream.

---

## 4.11 Electrical connections

The Rosemount 470XA has three cable entries for wiring.

### ⚠ WARNING

#### Wiring

It is the customer's responsibility to ensure that all wiring conforms to the local electrical codes or regulations.

---

If you intend to run the power and through a single entry, the lower left entry is the most convenient. If you intend to run the power and communication cables separately, the lower left entry is most convenient for the power wiring, and the lower right entry is most

convenient for the communication wiring. You can use the upper right cable entry if there is not enough space to run all of the wiring through the two lower cable entries.

The cable entries are M32-threaded connections. If your gas chromatograph (GC) is CSA-certified, then Emerson will ship a certified M32-to- $\frac{3}{4}$ -in. conduit adapter and  $\frac{3}{4}$ -in. certified plugs with your GC. If your GC is ATEX/IECeX-certified, then Emerson will ship M32-certified plugs with your GC.

The maximum wire size for all of the GC's terminals is 12 AWG or 4 mm<sup>2</sup>. You can unplug the terminals from the backplane to make the connection and then plug them back into place.

**⚠ WARNING**

**Electrical hazard**

Shock, fire, or explosion may occur where electricity is the source of ignition in a potentially flammable or explosive atmosphere. Failure to de-energize the GC and not using proper personal protective equipment (PPE) may cause injury to personnel or damage equipment.

Make all electrical connections with no power applied.

To enable servicing in a potentially flammable or explosive atmosphere, install a customer-provided electrical power cut-off on the GC power connection outside of the hazardous area.

### 4.11.1 Terminal wiring

**Table 4-4: Terminal boards**

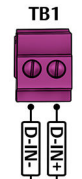
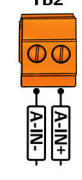
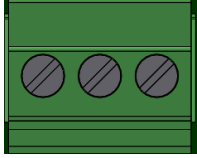
Terminal block number	Connects to	Image
TB1	Discrete input	
TB2	Analog input	
TB3	Discrete output	

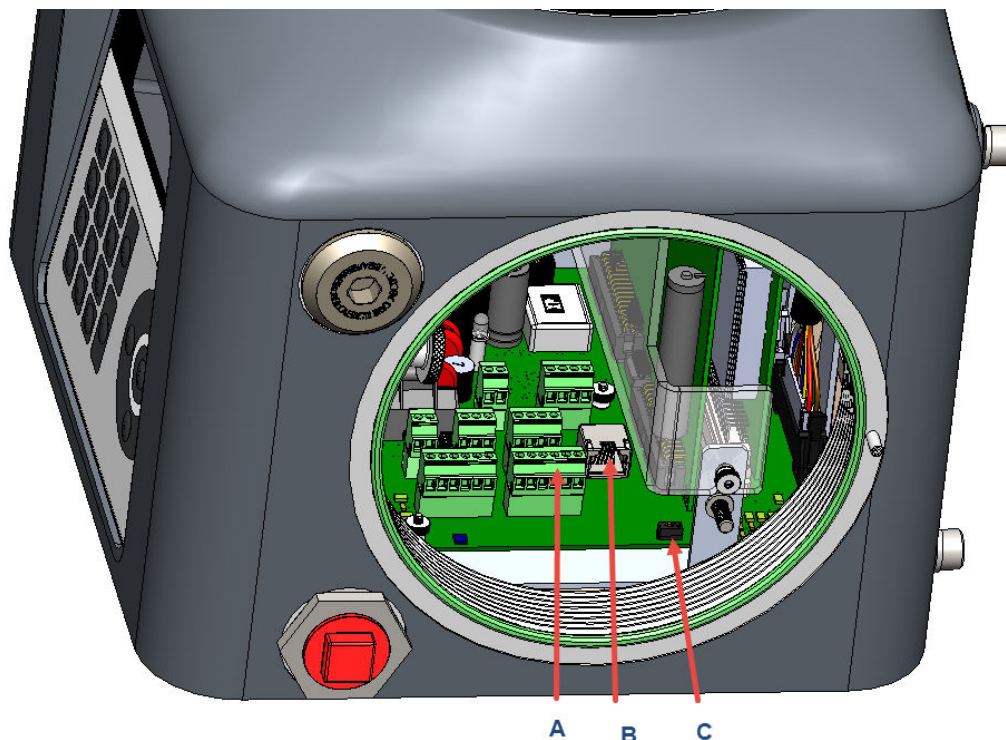
Table 4-4: Terminal boards (continued)

Terminal block number	Connects to	Image
TB4	COM1 port (RS-232)	<p>The diagram shows two green terminal blocks. The top one is labeled 'TB4' and has four terminals with labels: GND, TXD, RXD, and EX/RX+. The bottom one is also labeled 'TB4' and has four terminals with labels: GND, TXD, RXD, and EX/RX+.</p>
TB5	Ethernet 2	<p>The diagram shows a blue terminal block with four terminals labeled: RX-, RX+, TX-, and TX+.</p>
TB8	Power	<p>The diagram shows a red terminal block with two terminals labeled: - and +. Below the terminals is the text '(24 VDC)'.</p>
TB9	COM2 port (RS-232)	<p>The diagram shows two green terminal blocks. The top one is labeled 'TB9' and has four terminals with labels: GND, TXD, RXD, and EX/RX+. The bottom one is also labeled 'TB9' and has four terminals with labels: GND, TXD, RXD, and EX/RX+.</p>
TB10	Analog outputs (2)	<p>The diagram shows a yellow terminal block with four terminals labeled: AO2-, AO2+, AO1-, and AO1+.</p>

## 4.12 Connecting to Ethernet ports

The Rosemount 470XA has two Ethernet ports that can be configured with unique Internet protocol (IP) addresses, subnet masks, and gateway addresses.

**Figure 4-14: Ethernet ports on the backplane**



- A. Ethernet 2
  - Backplane location: TB5
  - Terminal type: Wired
- B. Ethernet 1
  - Backplane location: J9
  - Terminal type: RJ-45, dynamic host configuration protocol (DHCP)-enabled
- C. DHCP switch
  - Backplane location: SW1

- Ethernet port 1 is an RJ-45 connector designed to accept common Ethernet cable connections found on computers and other Ethernet enabled devices and is primarily intended for local connection to a computer, but can also be permanently connected to other Ethernet devices.
- Ethernet port 2 is a field terminated port primarily intended for connection to supervisory systems or other Ethernet enabled devices.
- Both ports can be used for Modbus<sup>®</sup> TCP communication and communication to the MON2020 configuration and diagnostics software.

---

**Note**

You can establish up to ten simultaneous Modbus TCP connections from the Modbus master. Connections attempts made after the tenth connection result in a No Response error.

---

## 4.12.1 Ethernet 1 port

Ethernet 1 was designed primarily for local connection to a computer, such as a technician's laptop, for occasional maintenance and diagnostic purposes. The connector is the same RJ-45 Ethernet connector commonly found on most Internet-capable devices.

---

**Note**

If your computer is not configured to automatically configure Ethernet settings, contact your information technology (IT) department for instructions on how to change your Internet protocol (IP) settings to an address in the same range as the Ethernet subnet on the gas chromatograph (GC) or to obtain an IP address and subnet for the GC that will work with your computer's settings.

---

If wiring Ethernet 1 to other Ethernet-enabled devices, such as a router, hub, or local area network, then set the DHCP server switch to OFF to ensure that the operation of the network is not affected.

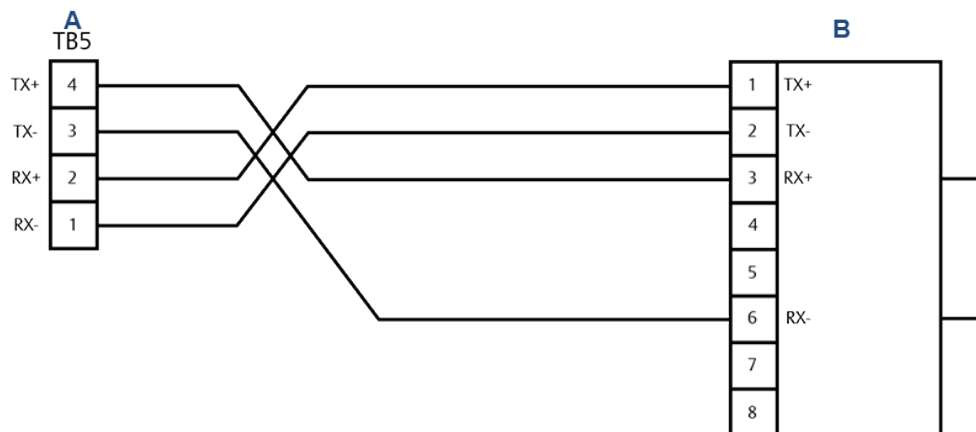
**Related information**

[Connect directly to a personal computer \(PC\) using the gas chromatograph's \(GC's\) Ethernet port](#)

## 4.12.2 Ethernet 2 port

---

**Figure 4-15: Ethernet 2 port on the backplane**



A. Ethernet port 2

B. Ethernet device

---

The second Ethernet port is intended to be connected to an Ethernet-enabled supervisory network such as a flow computer, supervisory control and data acquisition (SCADA) system, or distributed control system (DCS). You can also use this port to permanently connect to a maintenance network with Rosemount MON2020.

As this port is intended for connection to hard-wired Ethernet networks, you must configure the subnet and the gateway address appropriately for the network connection. Consult with your network administrator for the required settings.

### 4.12.3 Connect directly to a personal computer (PC) using the gas chromatograph's (GC's) Ethernet port

The GC's DHCP server feature and its Ethernet port on the backplane at **J22** allow you to connect directly to the GC. This is a useful feature for GCs that are not connected to a local area network (LAN); all that is needed is a PC and a CAT 5 Ethernet cable.

#### Prerequisites

##### Note

The PC must have an Ethernet network interface card (NIC) that supports the automatic medium-dependent interface crossover (Auto-MDIX) technology and either an Ethernet cable of at least CAT 5 or an Ethernet Crossover Cable of at least CAT 5.

##### Note

The GC can be connected (or remain connected) to the local network on **TB11** on the backplane while the DHCP feature is being used.

#### Procedure

1. Plug one end of the Ethernet cable into the PC's Ethernet port and the other end into the GC's **RJ-45** socket on **J22** on the backplane.
2. Locate the set of switches at **SW1**, directly beneath the Ethernet port on the backplane. Flip the switch that is labeled **1** to ON. This starts the GC's DHCP server feature.

#### NOTICE

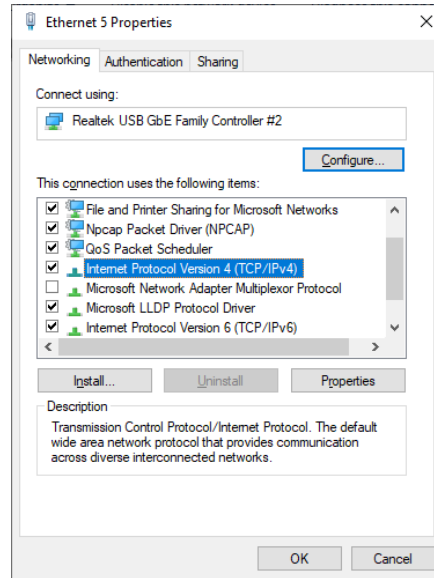
Although it is possible to use the Ethernet cable to connect the GC, by way of the **RJ-45** socket, to the local network, do not do so if the **SW1** switch has been turned on. Setting the **SW1** switch to ON puts the GC in server mode, and doing so while the GC is plugged into the LAN will disrupt the local network's functioning.

The GC's DHCP server feature starts. The server takes approximately 20 seconds to initialize and start up.

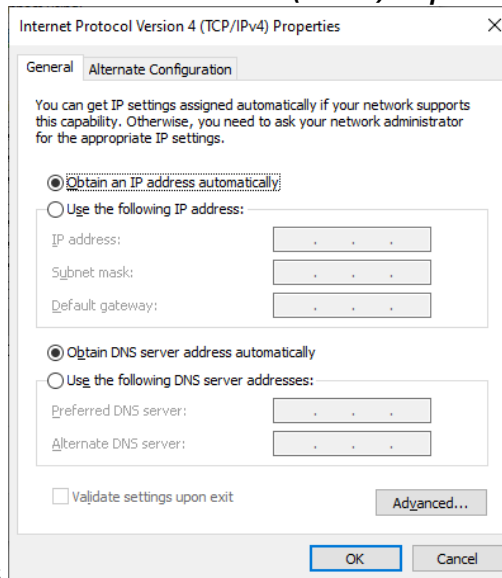
3. Wait for 20 seconds and then do the following to ensure that the server has provided an Internet protocol (IP) address to the PC:
  - a) From the PC's desktop, go to **Start** → **menu** → **Control Panel** → **Network and Sharing Center**.  
The **Network Connections** screen lists all Dial-up and LAN / High-Speed Internet connections installed on the PC.
  - b) In the list of LAN / High Speed Internet connections, find the icon that corresponds to the PC-to-GC connection and check the status that displays beneath the LAN.  
It should show the status as Connected. The PC is now capable of connecting to the GC. If the status is Disconnected, the PC may not be configured to accept IP addresses. Continue to [Step 4](#).
4. Configure the PC to accept IP addresses.
  - a) Go to **Start** → **Control Panel** → **Network and Sharing Center**.
  - b) Select **Change adapter settings**.



- c) Right-click **Local Area Connection** and select Properties. The **Local Area Connection Properties** dialog opens.
- d) In the **Connection** list box, select Internet Protocol (TCP/IPv4).



- e) Click **Properties**. The **Internet Protocol Version 4 (TCP/IP) Properties** dialog



opens.

- f) To configure the PC to accept IP addresses issued from the GC, select the **Obtain an IP address automatically** and **Obtain DNS server address automatically** radio buttons.
- g) Click **OK** to save the changes and to close the **Internet Protocol Version 4 (TCP/IP) Properties** dialog.
- h) Click **OK** to close the **Local Area Connection Properties** screen.

- i) Return to the **Network Connections** screen and confirm that the appropriate icon's status reads Connected.
5. Connect to the GC.
    - a) Do one of the following:
      - Open the **GC Directory** screen and click **Insert** to create a new GC entry with an IP address of 192.168.135.100.
      - Select an existing GC entry for direct DHCP connection. Click **Ethernet 1** to open the **Ethernet 1 Connection Properties** screen. Edit the IP address to 192.168.135.100.
    - b) Close the **GC Directory** screen.
    - c) In Rosemount MON2020, go to **Chromatograph** → **Connect**.
    - d) On the **Connect to GC** screen, click the **Ethernet 1** button next to the appropriate entry for direct DHCP connection.

#### Postrequisites

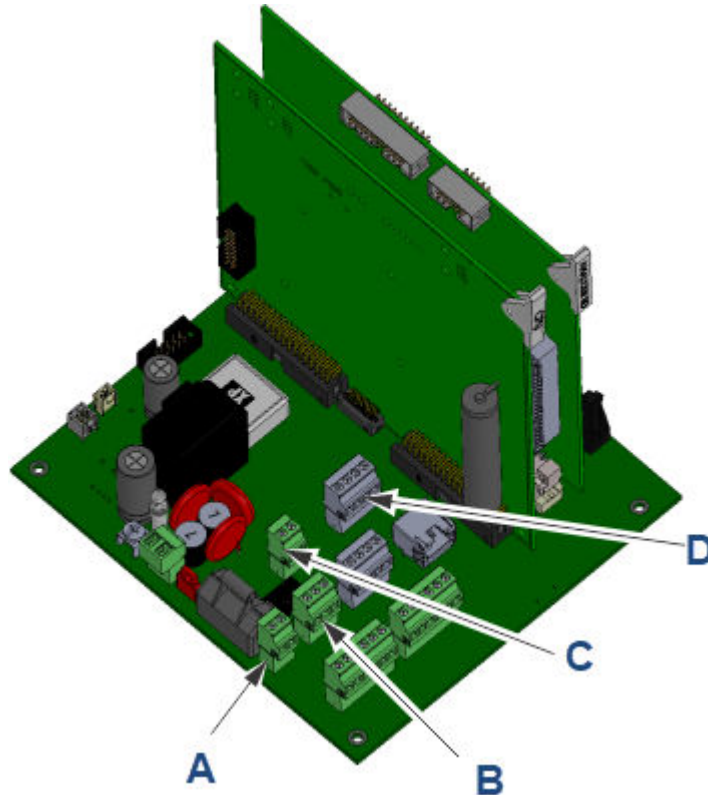
### NOTICE

If you power cycle the GC, you will lose connectivity.

---

## 4.13 Connecting to external devices

Figure 4-16: Digital and analog device connections



- A. Digital input: terminal block (TB1)
- B. Digital output (TB3)
- C. Analog input (TB2)
- D. Two analog outputs (TB10)

### 4.13.1 Digital inputs

You can configure the discrete digital input to trigger alarms, change the stream sequence, or perform other functions. The input is optically isolated and can accept either a contact closure such as a pressure switch or a DC voltage signal between 5 and 30 Vdc at 1 Amp.

Figure 4-17: Wiring for a digital input connected to a contact closure device

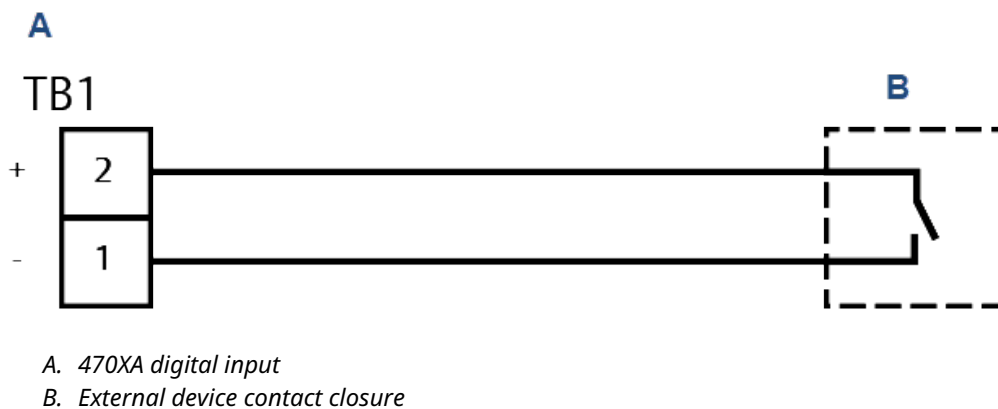
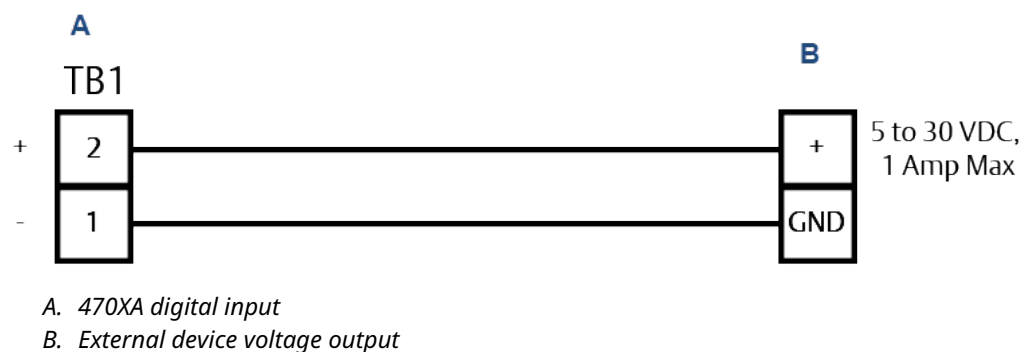


Figure 4-18: Wiring for a digital input connected to a voltage output device such as a flow computer

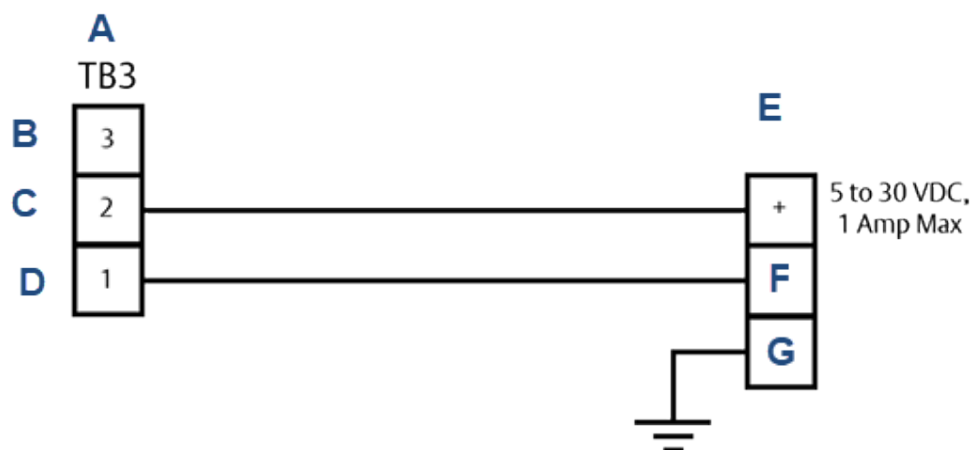


### 4.13.2 Digital output

The digital output is a Form C dry contact relay output with normally open and normally closed contacts. The output is typically configured as an alarm output, but can be configured for other purposes.

When using the digital output as an alarm output, it is important to configure the circuit for fail-safe operation. To do this, use and configure the normally open contact so that a power failure will raise an alarm in the connected device.

**Figure 4-19: Wiring for a digital output for a fail-safe mode**

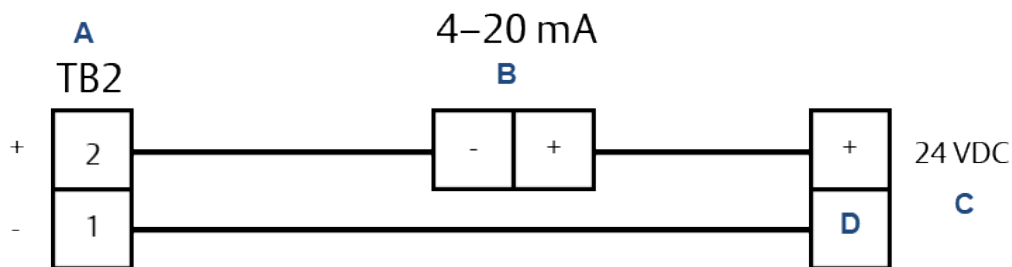


- A. Digital output
- B. Normally closed
- C. Common
- D. Normally open
- E. External device voltage output
- F. Digital input
- G. Ground

### 4.13.3 Analog input

You can use the analog input to monitor and generate an alarm from an external signal, such as a pressure transmitter on the carrier gas bottles, or as a composition component input from another analyzer, such as a moisture or H<sub>2</sub>S analyzer. The analog input is optically isolated and requires external loop power.

**Figure 4-20: Analog input wiring with an external power supply and a loop-powered transmitter**

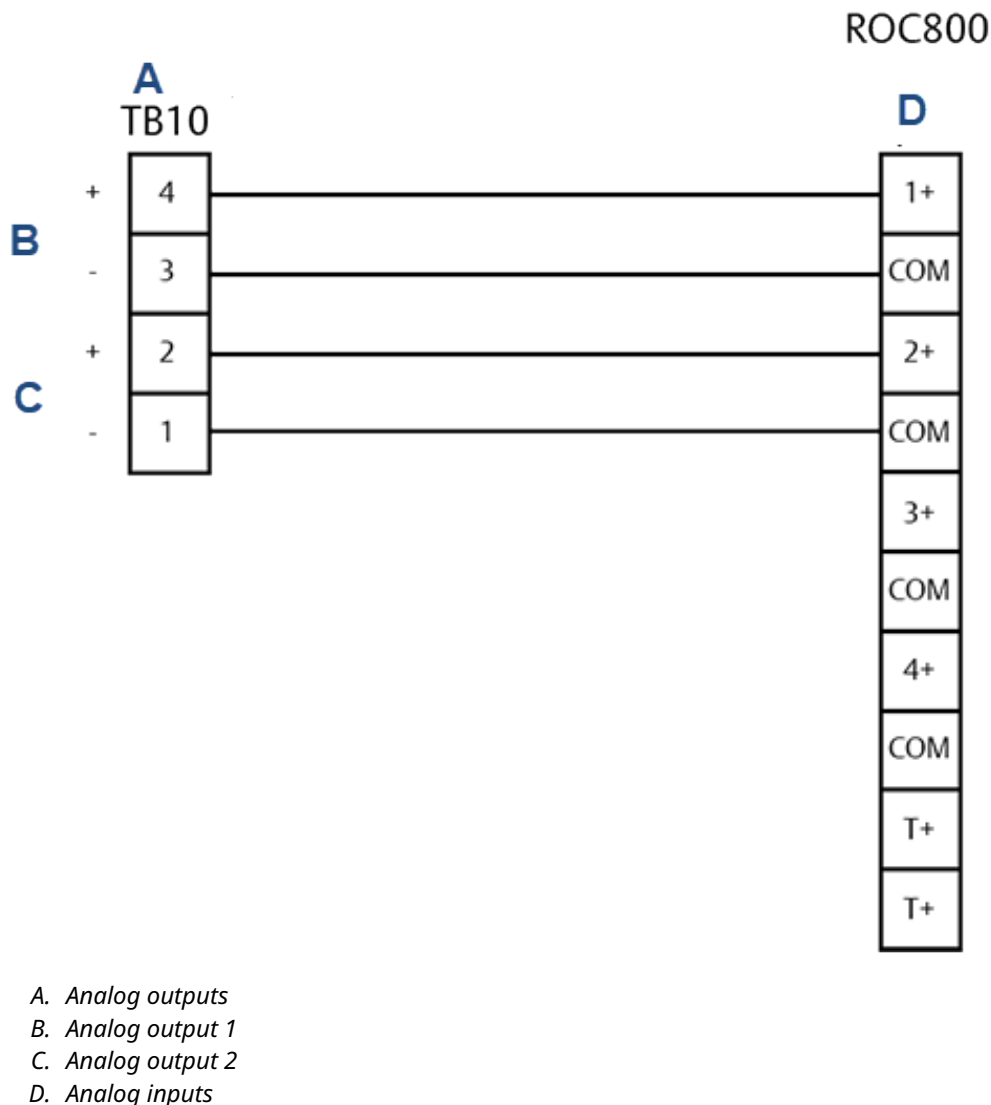


- A. Analog input
- B. Transmitter
- C. Power supply
- D. Ground

### 4.13.4 Analog outputs

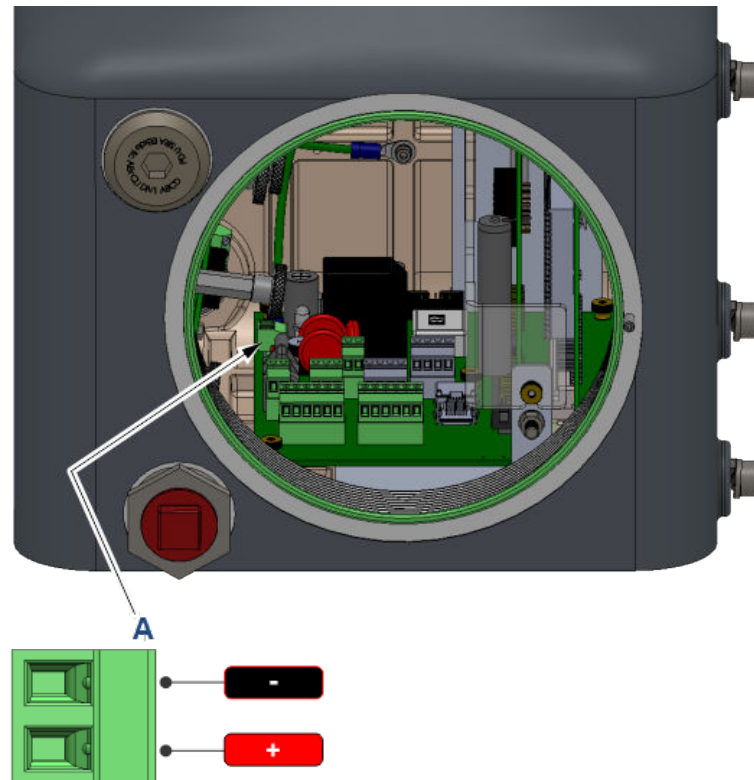
The Rosemount 470XA has two analog outputs. Each analog output can be used to transmit a gas chromatograph (GC) variable, such as an energy value or a component concentration, as a 4 to 20 mA signal. The outputs are self-powered and require a loop resistance of less than 500 ohms.

Figure 4-21: Analog output connected to an ROC800 analog input card



## 4.14 Connecting to power

Figure 4-22: 24 Vdc power source wiring



A. 24 Vdc power wiring input

### 4.14.1 Wiring power source

- Ensure that all wiring, as well as the customer-provided circuit breaker or power disconnect switch locations, conform to all the standards: national, local, state, and other jurisdictions.
- Provide the gas chromatograph (GC) with a 5-amp circuit breaker for protection.
- The Rosemount 470XA requires at least 21 Vdc at the terminals on the backplane to operate correctly. When wiring for DC power connections, account for the voltage drop due to the cable's resistance.

#### **⚠ WARNING**

To enable servicing in a potentially flammable or explosive atmosphere, install an electrical power cut-off on the GC power connection outside of the hazardous area.

Table 4-5 and Table 4-6 estimate the voltage drop and the maximum length of cable with a 24 Vdc supply at the maximum power draw (55 W) while the analytical oven heats up during start-up.

**Table 4-5: American wire gauge (AWG)**

	12	14	16
Resistance per 1000 ft. (in ohms)	1.62	2.58	4.08
Voltage drop per 1000 ft. at 2.5 A (in Vdc)	4.05	6.44	10.21
Maximum length (3 Vdc power drop) in ft.	740	465	293

**Table 4-6: Metric wire size**

	2.5	1.5
Resistance per 100 m (in Ohms)	1.3	2.1
Voltage drop at 100 m at 2.5 A (in Vdc)	3.25	5.25
Maximum length (3 Vdc power drop) in meters	92	57

## 4.14.2 Grounding precautions

Follow these general precautions for grounding electrical and signal lines:

### NOTICE

Ground the gas chromatograph (GC) through the ground terminal on the left hand lower side of the lower housing.

- Metal conduit used for process signal wiring must be grounded at conduit support points (intermittent grounding of conduit helps prevent induction of magnetic loops between the conduit and cable shielding).
- A single-point ground must be connected to a copper-clad, 10-ft. long, 3/4-in. diameter (3 m long, 19.1 mm diameter) steel rod, which is buried, full-length, vertically into the soil as close to the equipment as is practical.

### NOTICE

The grounding rod is not furnished.

- Resistance between the copper-clad steel ground rod and the earth ground must not exceed 25 Ohms.
- On ATEX-certified units, the external ground lug must be connected to the customer's protective ground system via 9 AWG (6 mm<sup>2</sup>) ground wire. After the connection is made, apply a non-acidic grease to the surface of the external ground lug to prevent corrosion.
- The equipment-grounding conductors used between the gas chromatograph (GC) and the copper-clad steel ground rod must be sized according to your local regulations.



## 4.15 Starting up and configuring the gas chromatograph (GC)

### 4.15.1 Applying carrier and actuation gas

#### **⚠ WARNING**

Do not use hydrogen as actuation gas.

#### **NOTICE**

Applying carrier gas without actuation gas can result in a direct path of the carrier gas to the vent that rapidly uses up the carrier gas supply.

### **Apply carrier and actuation gas from the same line**

#### **Procedure**

1. Back off the bottle regulator so that when you open the bottle valve, there will be no pressure applied.
2. Open the bottle valve.
3. Slowly increase the regulated pressure to 90 psig (6.2 barg).
4. Leak check the lines from the bottle to the gas chromatograph (GC).

### **Apply carrier gas and actuation gas separately**

#### **Prerequisites**

If using a separate actuation gas supply, apply pressure and leak check the actuation gas first and then repeat for the carrier gas.

#### **Procedure**

1. Back off the bottle regulator for the actuation gas, so that when you open the bottle valve no pressure is applied.
2. Open the actuation gas bottle valve.
3. Slowly increase the regulated pressure of the actuation gas to 90 psig (6.2 barg).
4. Leak check the lines from the actuation gas bottle to the gas chromatograph (GC).
5. Back off the bottle regulator for the carrier gas, so that when you open the bottle valve no pressure is applied.
6. Open the carrier gas bottle valve.
7. Slowly increase the regulated pressure.
  - If using helium as carrier gas, increase the pressure to 90 psig (6.2 barg).
  - If using hydrogen as carrier gas, increase the pressure to 60 psig (4.1 barg).
8. Leak check the lines from the carrier gas bottle to the GC.

## 4.15.2 Apply calibration gas

### Procedure

1. Close the calibration gas isolation valve on the sample handling system.
2. Back off the bottle regulator so that when the bottle valve is opened, there will be no pressure applied.
3. Open the bottle valve.
4. Slowly increase the regulated pressure to 20 psig (1.4 barg).
5. Leak check the lines from the bottle to the gas chromatograph (GC).

---

### Note

Do not open the isolation valve to the calibration gas yet. This will be done when you start up the GC.

---

## 4.15.3 Apply sample gas

Do the following for each sample line.

### Procedure

1. Close the sample isolation valve on the sample handling system.
2. Back off the sample regulator so that when the sample point isolation valve is opened, there will be no pressure applied.
3. Open the sample point isolation valve.
4. Leak check the lines from the bottle to the gas chromatograph (GC).

---

### Note

Do not open the isolation valve to the calibration gas yet. This will be done when you start up the GC.

---

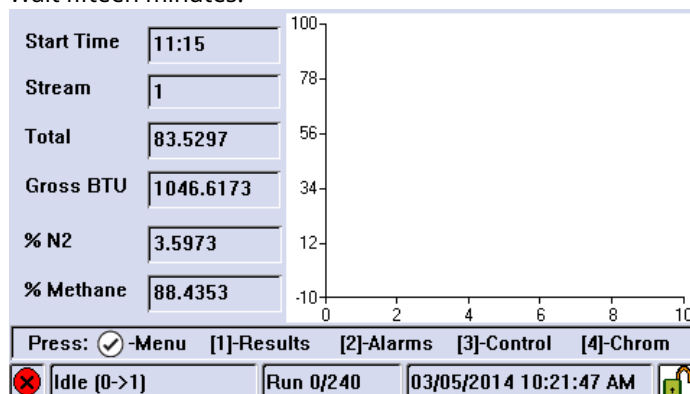
## 4.15.4 Turn on power for the first time

At this point, actuation gas and carrier gas should be flowing through the gas chromatograph (GC). The GC can take up to four hours to heat up to temperature. During this time, you can configure the software and purge the system.

### Procedure

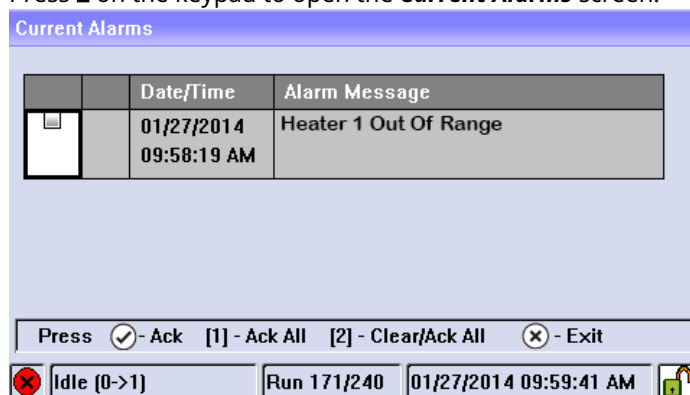
1. Turn on the power supply to the gas chromatograph (GC).  
The local operator interface (LOI) **Bootup** screen displays. The bootup process takes less than three minutes. When the **Home** screen displays, bootup is complete.

- Wait fifteen minutes.



A red alarm icon should be visible in the lower left corner of the **Home** screen.

- Press **2** on the keypad to open the **Current Alarms** screen.



### **WARNING**

After you log in for the first time, make sure to change your password.

- Confirm that the alarm that was triggered was the **Heater 1 Out Of Range** alarm. Other possible alarms are the **GC Idle** alarm, **Carrier Pressure Low** alarm, and the **Power Failure** alarm.

#### **Note**

If the **Current Alarms** screen displays the **Carrier Pressure Low** alarm, confirm that the carrier gas supply is on and that the pressure regulator is set to 90 psig (6.2 barg).

If the alarm persists, see [Troubleshooting](#). Because this is the first time that the GC has been turned on, you can ignore the other alarms.

- Press **2** to acknowledge and clear the alarm.

#### **Note**

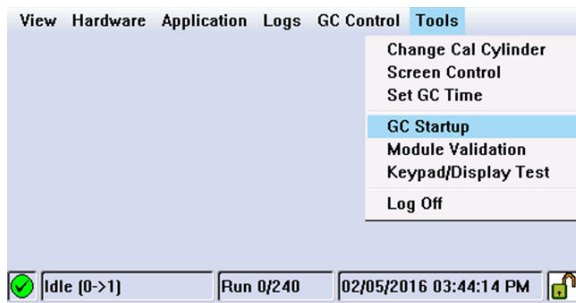
The **Heater 1 Out Of Range** alarm will reappear every fifteen minutes until the GC reaches its temperature set point. Continue to press **2** as necessary.

- Press **Exit** to return to the **Home** screen.

## 4.15.5 Run the Startup Assistant

### Procedure

1. Press **Enter** to go to the **Main Menu**.
2. Press **Right** to move to the **Tools** menu.
3. Press **Down** to move to the **GC Startup** command and press **Enter**.



The **GC Startup** screen displays.

4. Press **Enter** to continue.
5. To set gas pressures:
  - a) Confirm all the gas lines are connected and all valves are open.
  - b) Confirm the carrier, actuation, calibration, and sample pressures are set correctly.
  - c) Once confirmed, press **Enter** to continue.
6. To enter analyzer information:
  - a) Press **Edit** to activate a field.
  - b) Use the numeric keys to enter the analyzer name
  - c) Press **Enter** to accept an entry and to deactivate the field.
  - d) Use the arrow keys to move to the next field.
  - e) Repeat the steps for company name, location, and date and time. Press **Enter** to continue.
  - f) If your country employs Daylight Savings Time, use MON2020; go to **Chromatograph** → **View/Set Date Time**, and select the **Day Light Savings** check box, which is unselected by default.
7. To configure communications:
  - a) Enter the serial port settings.
  - b) Once done, press **Enter** to continue and configure the following:

**Table 4-7: Communication settings**

Communication type	Configuration description
Modbus ID	The address that the host device will use to communicate with the gas chromatograph (GC). For applications where the GC is the only slave device on the network, the Modbus ID is typically set to 1. For multi-dropped applications where the GC is one of several on the serial network, the Modbus ID needs to be unique. Refer to your host device configuration to determine the Modbus ID to be configured on the GC.

**Table 4-7: Communication settings (continued)**

Communication type	Configuration description
Baud rate	The baud rate can be set at the standard rates from 1,200 baud up to 57,600. For Modbus® communications, the typical setting is 9,600.
Data/stop bits	The number of bits used for communications and to indicate the end of a message. The typical setting for ASCII mode communications is 7. The typical setting for remote terminal unit (RTU) mode communications is 8. Typically, Stop bit is set to 1.
Parity	The error checking mode for the parity bit in ASCII mode messages. This can be set to either ODD or EVEN for ASCII mode communications and must match the host device's settings. Set to NONE for RTU mode communications.
MAP file	The Modbus address map. By default, this is set to SIM_2251, which is the most common communication mapping for flow computer to GC communications. Refer to the <a href="#">Rosemount MON2020 Software for Gas Chromatographs Manual</a> to learn more about configuring custom maps.
Port	The selection between RS-232 and RS-485 physical layer communication protocol.

**Note**

The 470XA does not have a setting for ASCII or RTU mode. The GC automatically detects the mode during its initial communications with the host device and automatically selects the correct mode.

**Note**

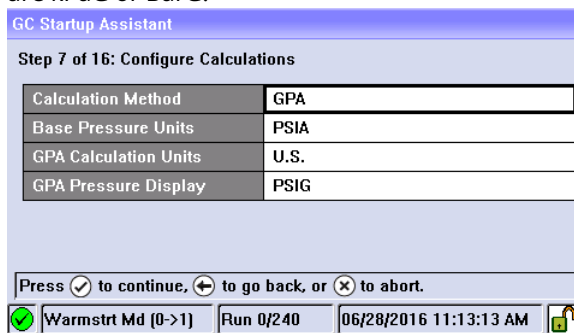
Obtain the required serial port settings from polling devices prior to configuring the settings on the GC.

8. Configure TCP/IP settings. Make a note of the Ethernet settings for both ports. Ethernet 1 is the RJ-45 terminal that is commonly used for local computer access. Ethernet 2 is the port that is commonly used for communication with a supervisory system such as a flow computer, RTU, supervisory control and data acquisition (SCADA) system, or distributed control system (DCS).
  - a) Enter the Ethernet settings according to the network requirements of your installation. Press **Enter** to continue.
  - b) If you intend to use Ethernet 1 for local access only, do not change the settings. Contact your network administrator or the person in charge of configuring your supervisory system network for the setting required to connect the GC to your network.
9. Reset averages time. Enter the day of the month to reset the monthly averages in the Day column.
  - a) Enter the time to reset the daily averages in the Reset Time column.
  - b) Enter the time to reset the weekly averages in the Weekday column.
  - c) Press **Enter** to continue.
10. Configure calculations. You can configure the 470XA to perform Gas Processing Association (GPA) calculations, International Organization for Standardization (ISO) calculations, or both. Enter the calculation settings. Once done, press **Enter** to continue.
  - a) Calculation Method.
 

Options are:

    - GPA

- ISO
  - GPA & ISO
- b) ISO Version (Only if ISO or GPA & ISO was selected as Calculation Method).  
Options are:
- ISO 6976: 2016
  - ISO 6876: 1995
- c) Base Pressure Units.  
Options are:
- PSIA
  - BarA
  - kPa
- d) GPA Calculation Units.  
Options are:
- U.S.
  - S.I.
- e) GPA Pressure Display (Only if GPA or GPA & ISO was selected as a Calculation Method).  
If you select U.S. units, PSIG is the default unit. If you select S.I. units, options are kPaG or BarG.



- f) ISO Pressure Display (Only if ISO or GPA & ISO was selected as Calculation Method).  
Options are:
- BarG
  - kPaG
- g) Primary and Secondary Temperature (Only if ISO or GPA & ISO was selected as calculation method).  
Options are:
- 0C/0C
  - 0C/15C
  - 0C/20C

- 15C/0C
- 15C/15C
- 15C/20C
- 20C/0C
- 20C/15C
- 20C/20C
- 25C/0C
- 25C/15C
- 25C/20C
- 0C/15.55C
- 15C/15.55C
- 20C/15.55C
- 25C/15.55C
- 15.55C/0C
- 15.55C/15C
- 15.55C/15.55C
- 15.55C/20C

h) Primary and Secondary CV Units (Only if ISO or GPA & ISO was selected as Calculation Method).

Options are:

- kJ/m<sup>3</sup>
- kCal/m<sup>3</sup>
- kWh/m<sup>3</sup>
- MJ/m<sup>3</sup>
- MJ
- MJ/mole

GC Startup Assistant	
Step 7 of 16: Configure Calculations	
Calculation Method	ISO
Base Pressure Units	BarA
ISO Pressure Display	BarG
Primary temperatures	15C/15C
Secondary temperatures	15C/15C
Primary CV Units	MJ/m <sup>3</sup> ▼

Press  to continue,  to go back, or  to abort.

Warmstr Md (0->1) Run 0/240 06/28/2016 11:15:38 AM

11. Configure stream usage. Designate stream 1, 2, 3, and 4 for calibration, analysis, or unused. For calibration and validation parameters, enter total number of runs, runs to be averaged, and starting times. Once done, press **Enter** to continue.

**Auto:** Check the box to automatically run at designated time. If the box is unchecked, you need to perform a manual calibration or validation. By default, the box is checked for calibration and unchecked for validation.

12. Enter the C6+ splits.

The GC assumes a ratio of heavy hydrocarbon components is used for the C6+ value. By default, there are four pre-defined ratios:

- C6+ 47/35/17
- C6+ GPA 2261-99
- C6+ 57/28/14
- C6+ 50/50/0

There is also a user defined option. Select the desired split and press **Enter** to continue.

13. Purge regulator. Purge the calibration gas regulator five times and then press **Enter** to continue.
14. Enter cal concentration. Enter the concentration values that are written on the calibration gas's certificate into the appropriate fields. Press **Enter** to continue.

---

**Note**

If the **Auto Calculate Methane** check box is selected, the methane value is calculated based on the values entered in the other fields.

---

15. Enter Uncertainty %. Enter the uncertainty values from the calibration gas's certificate into the appropriate fields. Press **Enter** to continue.

---

**Note**

If the calibration gas certificate does not list the uncertainty percentages, enter the default value of **2**.

---

16. Enter the cal gas energy value. Enter the calibration gas certificate energy value and the energy deviation limit values from the calibration gas's certificate.

---

**Note**

If the cal gas energy value from the certificate does not match the calculated value on the screen, enter the calculated value in the Cal Gas Energy Value field to ensure the energy value check during the calibration runs will not cause nuisance alarms.

---

17. Check the carrier pressure.

If the carrier pressure is not within the set point range, the **Carrier Pressure** screen will display **Out of Range** or **Low Pressure**. Adjust the carrier pressure regulator on the side panel until it reaches the set point and the Carrier Pressure Status is OK.

18. Wait for the temperature to stabilize.

The Startup Assistant waits until the temperature of the GC to reach the set point. Once this happens, the Startup Assistant automatically moves to the next screen.

19. Run calibration gas analysis.

The GC analyzes the calibration gas and repeat the analysis until the nitrogen value repeats within the uncertainty value entered. If after five runs, the nitrogen values are within specified limits, the Startup Assistant moves automatically to the next setup screen.

20. Run calibration sequence.



The GC runs the number of calibration cycles as entered during configure stream usage. If alarms are generated, the Startup Assistant halts until the alarms are cleared.

If no alarms sound, the setup of the 470XA is complete.



## 5 Using the Rosemount 470XA

You can perform many routine maintenance functions directly from the local operator interface (LOI).

In most cases, you can install and configure the gas chromatograph (GC) and place it on the line without using a computer.

### 5.1 Connect a local computer to the Rosemount 470XA

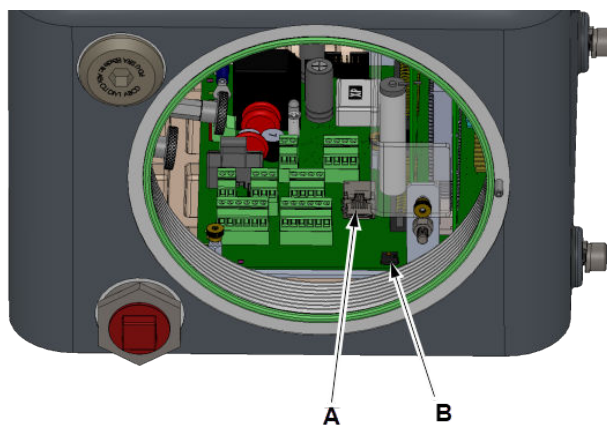
The **Ethernet 1** port uses a common RJ-45 connector for connections between local devices and includes a dynamic host configuration protocol (DHCP) server that automatically configures the settings of a computer when it connects to Ethernet 1.

Switch on the DHCP server for a local, single-computer connection or switch it off if you intend to connect Ethernet 1 to multiple devices on a local area network (LAN).

#### Procedure

1. Locate the switch at **SW1** on the backplane. It is in front of the **RJ-45** Ethernet plug. Flip the switch on. This activates the gas chromatograph's (GC's) DHCP server. The server typically takes 20 seconds to initialize and start up.

**Figure 5-1: Backplane switches and RJ-45 connector**



- A. RJ-45 Ethernet plug
- B. SW1 switch

#### Note

If you intend to connect the **RJ-45** port to a router or switch, ensure the GC's DHCP server is turned off by flipping the **SW1** switch to OFF. Connecting to your LAN with the DHCP server on disrupts your local network's functioning.

#### Note

You can connect the GC (or have it remain connected) to a local network via the wired Ethernet 2 port on the backplane while the DHCP feature is being used.

2. Connect between the GC's **RJ-45** connector and the local computer with a standard Cat 5 Ethernet cable.
3. Wait 30 seconds for the computer to update its TCP/IP settings.

---

**Note**

If your computer is not configured for dynamic Internet protocol (IP) addressing (static IP), you will need to configure the GC with a static IP address that is in the same subnet as your computer. See [Connect directly to a personal computer \(PC\) using the gas chromatograph's \(GC's\) Ethernet port.](#)

---

4. Start MON2020.

---

**Note**

Refer to [Gas Chromatograph Software and Firmware Downloads](#) to download the latest version of MON2020.

---

5. Select **Connect** on the **Chromatograph** screen.  
The **Connect to GC** screen opens.
6. Click the **Ethernet** button in the Direct-DHCP row.  
If the Direct-DHCP row is not visible, go to **File** → **GC Directory** and click **Add** to create a new entry. Make sure the IP address of the new entry is `192.168.135.100` and name it `Direct-DHCP`.  
The **Login** screen opens.
7. Enter your login information and press **OK**.  
The computer connects to the GC. The status bar at the bottom of the MON2020 screen shows the GC name, the alarm status, the mode, and the time and date of the connected GC.

## 5.2 Interacting with the local operator interface (LOI)

After the firmware has booted up, the LOI will display the **Home** screen.

To edit data, you must be logged in at the appropriate security level; if you attempt to edit data without being logged in, the **Login** screen will appear.

You will be logged off automatically after a period of 15 minutes of inactivity. The LOI will turn off the back light and return to the **Home** screen.

Figure 5-2: LOI



## 5.2.1 Menu operation

To view the **Main Menu** from the **Home** screen, press **Enter** (✓). Use the arrow keys to navigate through the menus.

To exit the **Main Menu** and return to the **Home** screen, press **Exit** (✗). If you were logged on when exiting the menu, you will be logged off.

## 5.2.2 Screen operation

Use the **Up** and **Down** arrow keys to navigate between a screen's fields.

Pressing **Down** while focus is on the last field on the screen moves the focus to the first field on the screen; alternatively, pressing **Up** while focus is on the first field on the screen moves the focus to the last field on the screen.

The **Select/Edit** button (✎) puts the field currently in focus into Edit mode, unless the focus is on a table, in which case pressing this key allows you to navigate between the table's cells.




If there is no field in Edit mode, you can exit that screen in one of two ways:

1. Press **Enter** (✓). If you made any changes to the screen's data, the LOI validates and saves them, while also generating the appropriate event log entries. The LOI then exits the current screen.
2. Press **Exit** (✕). If you made any changes to the screen's data, the LOI discards the changes and exits the current screen.

### 5.2.3 Entering numeric data

The valid key entries for numeric data are the numbers 1 - 9, the negative sign (-), and the decimal point (.).

The decimal point is only available for floating-point numbers.

- Press  to put the numeric field into Edit mode.
- Press  to validate and save new data.
- Press  to cancel changes made and keep the original data.
- Press **Left** to delete the digit immediately to the left of the currently highlighted number.
- Press **Right** to move the cursor to the right one space.

### 5.2.4 Enter alphanumeric data

To enter a letter into an alphanumeric field, press the appropriate key to cycle through its alphanumeric options until the desired letter appears.

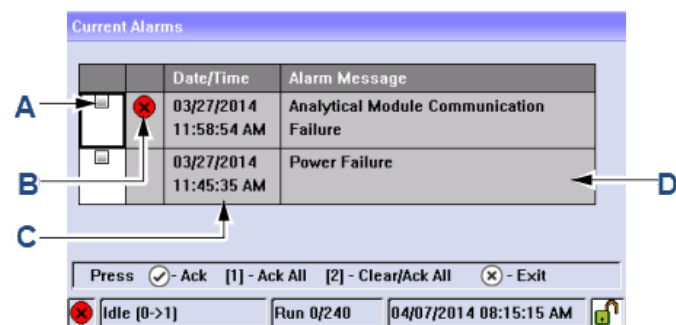
For example, to enter an **H**, press the **4GHI** key three times. The gas chromatograph (GC) also supports lowercase letters. For example, to enter a **b**, press the **2ABC** key six times.

## 5.3 Local operator interface (LOI) screen descriptions

### 5.3.1 View menu

#### Current Alarms screen

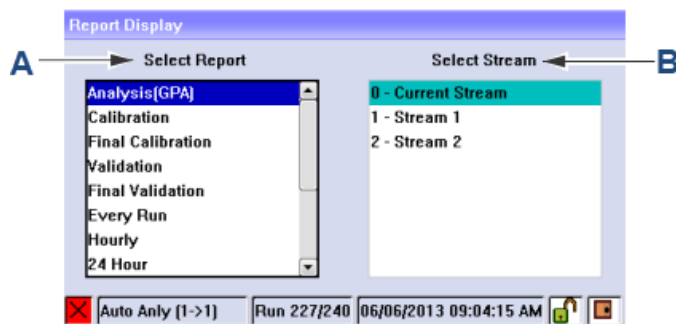
Figure 5-3: Current Alarms screen



- A. Check box: select the alarm's check box in order to acknowledge it.
- B. State: indicates whether the alarm is active (☒), unacknowledged (⚠), or inactive (blank).
- C. Date/Time: indicates the date and time at the gas chromatograph (GC) when the alarm condition occurred.
- D. Alarm Message: describes the alarm.

#### Report Display screen

Figure 5-4: Report Display screen

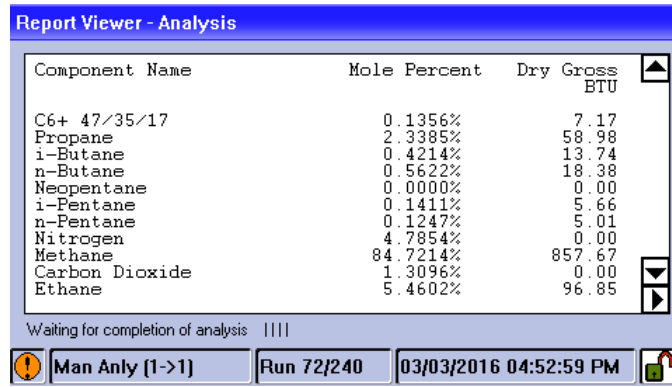


- A. Select Report  
Lists the report types that can be generated and displayed by the local operator interface (LOI).
- B. Select Stream  
Select the stream that was analyzed.

## Report Viewer screen

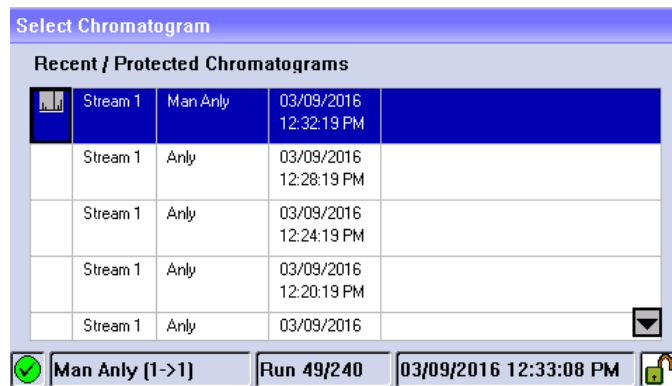
This screen displays after you select a report type from the **Report Display** screen. This screen's content is dependent upon the type of report selected.

Figure 5-5: Report Viewer screen



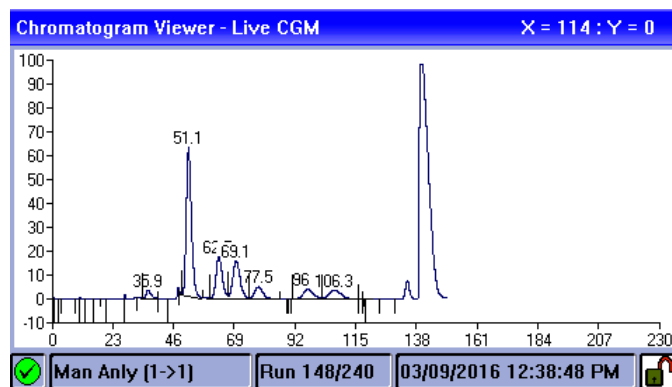
## Chromatogram screens

Figure 5-6: Select Chromatogram screen



The **CGM Viewer** screen displays when you select **Chromatogram** from the **View** menu.

Figure 5-7: Chromatogram Viewer - Live CGM





## Status Display screen

This screen displays the gas chromatograph (GC) parameter that is being monitored. You can change the parameter with Rosemount MON2020's **LOI Status Variables** screen.

**Value** The GC parameter's current value.

## 5.3.2 Hardware menu

### Heaters screen

Heaters		
Label	Heater 1	Heater 2
Switch	Auto	Fixed On
Setpoint (C)	80.0	
Temperature (C)	80.1	42.0
Current PWM	40.2	0.0
Status	Ok	Ok

⊗ Idle (0->1)    Run 0/240    03/27/2014 03:06:18 PM   

**Label** The heater's name. You can change this with Rosemount MON2020.

**Switch** Indicates the state of the heater:

**Auto** The heater is controlled by the gas chromatograph (GC).

**Fixed On** The heater is controlled manually, through user input.

**Not Used** The heater is shut off.

You can change the switch state with MON2020.

**Setpoint (C)** Indicates the target temperature. You can change the setpoint and the unit of measurement (Celsius or Fahrenheit) with MON2020.

**Temperature (C)** Indicates the current temperature.

**Current PWM** Indicates the current percentage of power being provided to the heater.

**Status** Indicates the operational state of the heater.

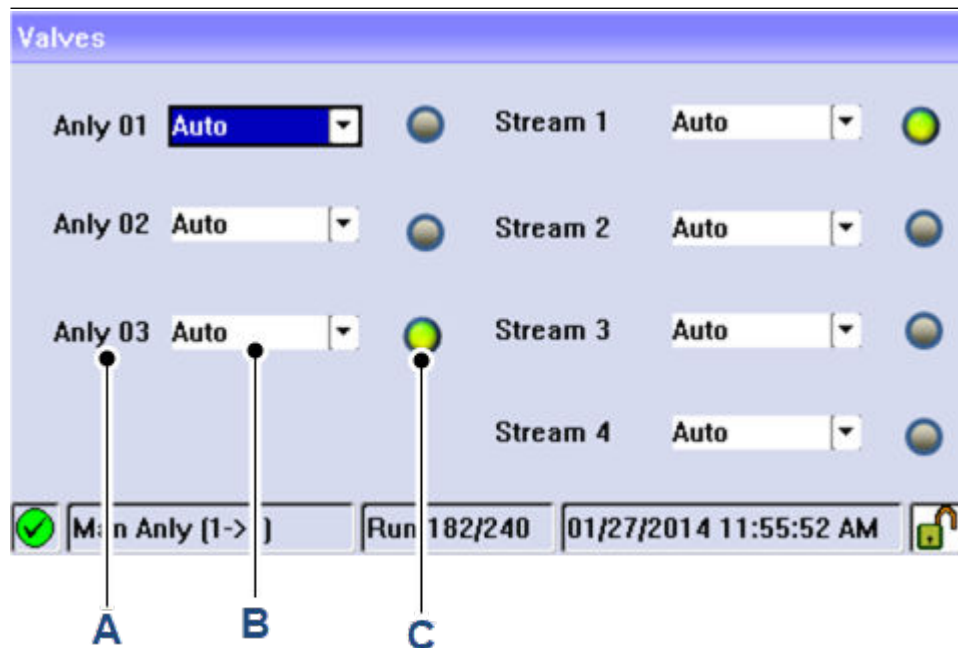
**OK** The heater's control card is installed and is working correctly.

**Not Installed** The heater is not installed.

**Out of Range** The heater is running but the temperature is not within control limits.

**Error** The GC cannot communicate with the heater.

## Valves screen





- A. *Label*  
The name of the valve as set in Rosemount MON2020.
- B. *Mode*  
There are three modes:
- *Auto*: The valve's on or off state is controlled by the gas chromatograph (GC).
  - *Off*
  - *On*
- The operator can also set the mode.
- C. *Status icon*  
Green means that the valve is on, or active; gray means the valve is off, or inactive.

## Carrier Pressure screen

Carrier Pressure	
Label	Carrier Pressure
Set Point (PSIG)	75
Current Value (PSIG)	75.48
Status	Ok



	Auto Anly (1->1)	Run 197/240	11/09/2022 12:09:58 PM	
---	------------------	-------------	------------------------	---

- Set Point** Indicates the target pressure. This pressure is controlled by the external regulator on the Rosemount 470XA.
- Current Value** Current pressure. The carrier pressure gauge value on the flow panel may be slightly different from the value on the **Carrier Pressure** screen. Adjust the carrier pressure regulator to the Set Point on this screen.
- Status** Indicates if the carrier pressure is within range of the set point. If the screen displays OK, the carrier pressure is within range. If the carrier pressure is out of range, the screen displays an alarm message.

## Discrete Inputs screen

Discrete Inputs	
Label	Discrete Input 1
Switch	Auto
Invert Polarity	Normally Open
Current Value	Off

	Man Anly (1->1)	Run 145/240	03/09/2016 12:58:45 PM	
---	-----------------	-------------	------------------------	---

- Label** The name of the discrete input as set in MON2020.
- Switch** Indicates the discrete input's operational mode. There are three modes:
- Auto: The gas chromatograph (GC) controls the discrete input's off or on state.
  - Off

- On

The operator can set the mode.

**Invert Polarity**

The **Invert Polarity** option reverses the way a voltage signal is interpreted by the discrete input. By default, the **Invert Polarity** option is set to Normally Open, which means that a low voltage signal is interpreted by the discrete input as ON, and a high voltage signal is interpreted by the discrete input as OFF. Setting **Invert Polarity** to Normally Closed means that a low voltage signal is interpreted by the discrete input as OFF, and a high voltage signal is interpreted by the discrete input as ON.

You can change this option with MON2020.

**Current Value**

Indicates the current state of the discrete input. Options are:

- On
- Off

## Discrete Outputs screen

Discrete Outputs	
Label	Discrete Output 1
Usage	Common Alarm
Switch	Auto
Current Value	Off

	Man Anly [1->1]	Run 48/240	03/09/2016 01:01:08 PM	
--	-----------------	------------	------------------------	--

**Label** The name of the discrete output as set in Rosemount MON2020.

**Usage** A discrete output's usage mode determines which signals are routed to it via the Limit Alarm and Discrete Alarm functions. A discrete output can be assigned one of the following usage modes:

- DO
- Common alarm
- Stream
- Analyzer01

You can change the usage mode with MON2020.

**Switch** Indicates the discrete output's operational mode. Options are:


- Auto: The discrete output is controlled by the gas chromatograph (GC).
- On
- Off

**Current Value** Indicates the current state of the discrete output. Options are:

- On
- Off

## Analog Inputs screen

Analog Inputs	
Label	Analog Input 1
Switch	Var_Standard
Current Value	23.5
Fixed Value	
Zero Scale	0
Full Scale	100
mA	7.68

Man Anly (1->1)    Run 59/240    03/09/2016 01:05:18 PM    

- Label** The name of the analog input as set in Rosemount MON2020.
- Switch** An analog input has two operational modes:
- Setting the switch to Variable means that the analog input is set automatically, based on the signal it receives.
  - Setting the switch to Fixed means that the analog input is set to the value that you enter in the **Fixed Value** field.
- You can change the field with MON2020.
- Current Value** Displays the current value of the analog input signal.
- Fixed Value** If the analog input is set to Fixed, then analog input signal is set to the value that you enter into this field. You can change the field with MON2020.
- Zero Scale** The minimum analog input signal value. This represents the engineering units when a 4 mA signal is received. You can change the field with MON2020.
- Full Scale** The maximum analog input signal value. This represents the engineering units when a 20 mA signal is received. You can change the field with MON2020.
- mA** Displays the amount of current being received, in milliamperes.

## Analog Output screens

Figure 5-8: Analog Output 1 screen

Analog Output		
Label	Analog Output 1	Analog Output 2
Switch	Var_Standard	Var_Standard
Variable	Last Analy_HV Gross BTU Dry	Last Analy_HV Gross BTU Sat
Current Value	1056	1037.63
Fixed Value		
Zero Scale	800	800

Man Anly (1->1)    Run 89/240    03/09/2016 01:09:48 PM   

Figure 5-9: Analog Output 2 screen

Analog Output		
Variable	Last Analy_HV Gross BTU Dry	Last Analy_HV Gross BTU Sat
Current Value	1056	1037.63
Fixed Value		
Zero Scale	800	800
Full Scale	1100	1100
mA	17.65	16.67

Man Anly (1->1)    Run 174/240    03/09/2016 01:11:13 PM   

- Label** The name of the analog output as set in Rosemount MON2020.
- Switch** An analog output has two operational modes:
- Setting the switch to Variable means that the analog output is proportional to the variable displayed in the Variables field.
  - Setting the switch to Fixed means that the analog output is set to the value that is entered in the appropriate Fixed Value field.
- Variable** Displays the system variable to which the analog output is associated. You can change this variable with MON2020.
- Current Value** Displays the current scaled value of the analog output signal.
- Fixed Value** If the analog output is set to Fixed, then analog output signal is set to the value that you enter into this field. You can change this field.
- Zero Scale** The minimum analog output signal value.
- Full Scale** The maximum analog output signal value.
- mA** Displays the amount of current being produced in milliamperes.

## 5.3.3 Application menu

### System screen

<b>Analyzer Name</b>	Displays the gas chromatograph (GC) name that appears in the status bar on the main window when Rosemount MON2020 is connected to the GC.
<b>System description</b>	Displays information that further identifies the currently connected system.
<b>Firmware Version</b>	Revision level of firmware of the GC.
<b>Serial Number</b>	Serial number of the GC.
<b>Company Name</b>	The name of the company that owns the GC.
<b>Location</b>	The physical location of the GC.
<b>Maintenance Mode</b>	Switches the GC to Maintenance mode and triggers an alarm that the GC is down for maintenance. You can switch this option on or off.
<b>Enable Energy Value Check</b>	At the end of a calibration, if this feature is enabled, the GC calculates the energy value and compares it against the value entered on the <b>Cal Gas Cert CV</b> screen. If the values diverge significantly, the <b>Calibration Energy Value Check Fail</b> alarm is triggered.
<b>Std Comp Table Version</b>	Indicates which version of the Gas Processing Association's (GPA's) standard component table is being used.
<b>GC ID</b>	Identification number.
<b>Config Checksum at Lockout</b>	The checksum of the configuration fields, which is calculated when the <b>Security</b> switch is locked.
<b>Current Config Checksum</b>	The GC will periodically recalculate and update the configuration checksum. This current value will be the latest calculated value.
<b>Checksum Update Time</b>	The time that the configuration checksum was last updated.
<b>Default Stream Sequence</b>	Displays the default sequence to be used by the GC during auto-sequencing.

### Component Data Table screen

<b>Component</b>	Displays the list of available components for the selected stream.
<b>Ret Time</b>	A component's retention time, which is the time, in seconds, when the apex of the component's peak is expected to appear.
<b>Resp Fact</b>	A component's response factor is equal to the value of the component's peak divided by the component's concentration value.
<b>Calib Conc</b>	The concentration amount, in mole percent, of the component that is present in the calibration gas.
<b>Uncert %</b>	The maximum acceptable percent of deviation between the new sample concentration value for the specified component and its calibration concentration value.

## Calibration Gas Info screen

Displays the calibration concentration per component as entered from the calibration certificate.

Press **Enter** to display the Uncertainty percentage.

Press **Enter** again to display Cal Gas Energy Value.

## Timed Events screen

**Event Type** Displays the type of event that occurred.

**Valve/Det** The ID number or name of the valve or detector that was affected by the event.

**Value** The value depends on the event that is displayed in the Event Type column:

- Slope Sensitivity and Peak Width: The number of points to be used.
- Single Baseline
  - Off
  - End
  - Bgn
- All other events: On or Off.

**Time(s)** Indicates at what time, in seconds, the event will occur during the analysis.

## Reset Time screen

**Reset Time** The time of day daily reports are run

**WeekDay** The day of the week that weekly reports are run

**Day** The day of the month that monthly reports are run

## Calculations Configuration screen

**Calculation Method** The gas chromatograph (GC) is either configured to perform Gas Processors Association (GPA) calculations, International Organization for Standardization (ISO) calculations, or both.

**Base Pressure Units** Units used for calculations.

On this screen, you can configure the following:

- ISO Pressure Units
- ISO Version
- Primary Temperature
- Secondary Temperature
- Primary CV Units
- Secondary CV Units
- GPA Calculation Units
- GPA Pressure Units



## Streams screen

<b>Label</b>	Name of the stream.
<b>Usage</b>	Type of stream. There are four types: <ul style="list-style-type: none"><li>• Analy (Analysis)</li><li>• Cal (Calibration)</li><li>• Validate (Validation)</li><li>• Unused</li></ul>
<b>Tot</b>	Number of runs to make for each calibration or validation.
<b>Avg</b>	The number of most-recent calibration or validation runs to use in the average calculation. For example, if five calibration runs are performed and Avg is set to 3, then the last three runs of the five are used to average the calibration results.
<b>Date/Time</b>	Date and time at which the first automatic calibration or validation should be performed.
<b>Base prs</b>	Pressure of the gas in pounds per square inch (psia).

## Communications screen

<b>Label</b>	Name of the port. This can be changed using Rosemount MON2020.
<b>Modbus ID</b>	Identification number of the Modbus <sup>®</sup> device used by a host device to communicate with the gas chromatograph (GC).
<b>Baud Rate</b>	Baud rate setting. Can be set to one of the following: <ul style="list-style-type: none"><li>• 1200</li><li>• 2400</li><li>• 9600</li><li>• 19200</li><li>• 38400</li><li>• 57600</li></ul>
<b>Data Bits</b>	Number of data bits. For remote terminal unit (RTU) communication, this is typically set to 8 bits, and for ASCII mode this is typically set to 7 bits.
<b>Stop Bits</b>	Number of stop bits. This can only be set to 1 in the Rosemount 470XA.
<b>Parity</b>	Parity check method. For RTU mode, this should be set to NONE. For ASCII mode, this can be set to EVEN or ODD.
<b>MAP File</b>	Name of the Modbus MAP file being used by the port. The SIM_2251 Modbus map is the same registers as the Rosemount Model 500/2350A C6+ application that is commonly pre-configured in custody transfer flow computers and RTU systems and uses the Emerson Modbus message format. The default map is a fully configurable Modbus map that uses the MODICON message format.  You can use Rosemount MON2020 software to modify both Modbus maps. For details on modifying the Modbus maps, refer to the <a href="#">Rosemount MON2020 manual</a> .

**Port** Type of physical message protocol to be used for the port. Each port can be set to RS-232 or RS-485 mode independently.

---

**Note**

The port will automatically communicate in ASCII or RTU mode, depending on the message format received from the host device.

---

## TCP/IP Settings screen

**Ethernet 1 IP Address** Internet protocol (IP) address used to connect to the gas chromatograph's (GC's) **RJ-45** Ethernet port.

**Ethernet 1 Subnet Mask** Subnet mask for the Eth1 IP address.

**Ethernet 1 Gateway** Default gateway address for the Eth1 IP address.

**Ethernet 1 DHCP** Indicates whether or not the **RJ-45** Ethernet port's dynamic host configuration protocol (DHCP) feature is enabled. The DHCP enable switch is located on the backplane at **SW1**.

**Ethernet 2 IP Address** IP address to use to connect to the GC's wired Ethernet port.

**Ethernet 2 Subnet Mask** Subnet mask for the Eth2 IP address.

**Ethernet 2 Gateway** Default gateway address for the Eth2 IP address.

**LOI IP Address** IP address for the GC's local operator interface (LOI) port.

## 5.3.4 Logs menu

### Alarm Log screen

**User Name** User name of the person who is logged in to the gas chromatograph (GC).

**Date/Time** Indicates the date and time when the alarm condition began.

**State** Indicates whether the alarm is active (SET) or inactive (CLR).

**Alarm Msg** Describes the alarm condition.

### Event Log screen

**User Name** User name of the person who made the change.

**Date/Time** Indicates the date and time when the event occurred.

**Event Msg** Displays a description of the event.

### Maintenance Log screen

**User Name** User name of the person who made the log entry.

**Date/Time** Date and time that the log entry was created.

**Message** Describes the nature of the maintenance activity that was performed. You can edit this field.

---


**Note**

To add an entry to the log, press **1** on the keypad.

---

## Add a new entry to the Maintenance Log

### Procedure

1. From the **Maintenance Log** screen, press **1** on the keypad.  
The **Add a New Maintenance Log** screen appears.
2. Use the **Up** or **Down** arrow keys to select the appropriate maintenance task from the drop-down list.
3. Press  to add the log message to the **Maintenance Log** screen.  
The entry and its creation date will appear at the top of the log.

## 5.3.5 GC Control menu

### Auto Sequence screen


Select the **Purge stream for 60 seconds** check box if you want to allow sample gas to flow through the sample loop for 60 seconds prior to beginning the first analysis.

To start the auto sequence process, press  on the keypad.

### Single Stream screen

Select the **Purge stream for 60 seconds** check box if you want to allow sample gas to flow through the sample loop for 60 seconds prior to beginning the first analysis.

Select the **Continuous operation** check box if you want to allow for the repeated analysis of the selected stream.

To start a single stream analysis, select a stream and then press  on the keypad.

### Halt screen

You must be logged in at least at the Regular user level to access this screen. If you are not already logged in, the **Login** screen displays.

To halt an analysis, press  on the keypad.


### Calibration screen

You must be logged in at least at the Regular user level to access this screen. If you are not already logged in, the **Login** screen displays.

There are two types of calibration:

- Select Normal to perform a manual calibration in which the component data table for the selected stream will be updated with calibration data **unless** the data is outside the acceptable deviations that are listed in the component data table.
- Select Forced to perform a manual calibration in which the component data table for the selected stream will be updated with calibration data **even if** that data is outside the acceptable deviations that are listed in the component data table.


Select the **Purge stream for 60 seconds** check box if you want to allow sample gas to flow through the sample loop for 60 seconds prior to beginning the first analysis.

To start a calibration, select a stream and then press  on the keypad.

## Validation screen

You must be logged in at least at the Regular user level to access this screen. If you are not already logged in, the **Login** screen displays.

Select the **Purge stream for 60 seconds** check box if you want to allow sample gas to flow through the sample loop for 60 seconds prior to beginning the first analysis.


To start a validation, select a stream and then press  on the keypad.

## Auto Valve Timing (AVT) screen

You must be logged in at least at the Regular user level to access this screen. If you are not already logged in, the **Login** screen will display.

This automatic procedure, which takes up to one hour to complete, includes the following sequence of tasks:


- Set the timing for each valve.
- Match all the component peaks.
- Adjust the timed events based on peak integration times.
- Run a calibration.
- Check the range and order of response factors.
- Adjust the retention time deviations to avoid peak overlapping.

To start the process, select a stream and then press  on the keypad.

After AVT starts, if AVT fails, the local operator interface (LOI) will show **AVT Initialization failed**. If AVT is successful, the LOI will show **AVT Initialization successful**.

## 5.3.6 Tools menu

### Screen Control screen

Use the **Up** or **Down** arrow keys to select a brightness level from the list box and then press  on the keypad.



### Set GC Time screen

You must be logged in at least at the Regular user level to access this screen.

If you are not already logged in, the **Login** screen displays.

To change the date or time:

#### Procedure


1. Press  to activate the MM text box.
2. Enter the appropriate number for the current month.
3. Press .
4. Move to the next text box.

5. Repeat [Step 1](#) through [Step 3](#) for the other text boxes.

## Enable or disable Daylight Savings Time

Daylight Savings Time is the practice of temporarily advancing clocks so that afternoons have more daylight and mornings have less. Typically, clocks are adjusted forward one hour near the start of spring and are adjusted backward in autumn. Since the use of Daylight Savings Time is not universal, you have the option of enabling or disabling it with the local operator interface (LOI).

### Procedure

1. Use **Down** to select the **Enable Day Light Savings** check box.
2. Press  to toggle the check box.

## 5.4 Common local operator interface (LOI) tasks

### 5.4.1 Configure the serial communications settings

To configure the serial port communications settings to communicate with Modbus<sup>®</sup> host devices, such as a flow computer, remote terminal unit (RTU), supervisory control and data acquisition (SCADA) system, or distributed control system (DCS), the protocol settings for all the devices on the network must match.

### Prerequisites

Obtain the required serial port settings prior to configuring the settings on the gas chromatograph (GC).

### Procedure

1. Go to the **Main Menu** and then to **Applications** → **Communications**. The **Communications** screen displays.
2. Enter the serial port settings.

**Modbus ID** Address that the host device will use to communicate with the GC. For applications where the GC is the only slave device on the network, the Modbus ID is typically set to 1. For multi-dropped applications where the GC is one of several on the serial network, the Modbus ID needs to be unique. Refer to your host device configuration to determine the Modbus ID to be configured on the GC.

**Baud Rate** Baud rate can be set at the standard rates from 1200 baud up to 57600. For Modbus<sup>®</sup> communications, the typical setting is 9600.

**Data Bits** Number of bits used for communications. The typical setting for ASCII mode communications is 7. The typical setting for RTU mode communications is 8.

**Stop Bits** Number of bits sent to indicate the end of a message. Typically set to 1.

**Parity** Error checking mode for the parity bit in ASCII mode messages. This can be set to either ODD or EVEN for ASCII mode communications and must match the host device's setting. Set to NONE for RTU mode communications.

**MAP File** The Modbus address map. By default, this is set to SIM\_2251, which is a pre-configured map with the same mapping as the Rosemount 2251 controller and is the most common communication mapping for flow

computer-to-GC communications. Refer to the [Rosemount MON2020 manual](#) to learn more about configuring custom maps.


**Port** Physical layer communication protocol. Select either RS-232 or RS-485.

---

**Note**

The Rosemount 470XA does not have a setting for ASCII or RTU mode. The GC automatically detects the mode during its initial communications with the host device and automatically selects the correct mode.

---

3. Press  to save the changes and return to the **Main Menu**.

## 5.4.2 Set the time

### Procedure

1. Press **Enter** to go to the **Main Menu**.
2. Go to **Tools** → **Set GC Time**.  
The **Set GC Time** screen displays.
3. Set the current date and time.
  - a) Press **Edit** to activate a field.
  - b) Use the numeric keys to enter the date and time.
  - c) Press **Enter** to accept an entry and to deactivate the field.
  - d) Use the arrow keys to move to the next field.
4. If your country employs Daylight Savings Time, select the **Enable Day Light Savings** check box, which is unselected by default.

**Note**

You must use Rosemount MON2020 to configure Daylight Savings Time.

---

## 5.4.3 Set the calibration gas concentration values

**Note**

You can also use Rosemount MON2020 to enter these values. In MON2020, go to **Application** → **Component Data**.

---

### Procedure

1. Go to the **Main Menu**.
2. Go to **Application** → **Calibration Gas Info**  
The **Calibration Concentration** screen displays.

**Note**

If more than one calibration stream is configured, from the **Streams** screen, select the Calibration Stream and then select a Cal Stream. The **Calibration Concentration** screen displays.

---


3. Enter the concentration values that are written on the calibration gas certificate into the appropriate fields on the **Calibration Concentration** screen.

---

**Note**

If the **Auto Calculate Methane** check box is selected, the methane value is calculated based on the values entered in the other fields. This value updates after each new entry.

---


4. If the calibration gas certificate displays a methane value, compare it to the **Calibration Concentration** screen's methane value. If the values do not match, confirm that you have entered the other values correctly.
5. Press .  
The **Uncertainty %** screen displays.
6. Enter the uncertainty values from the calibration gas' certificate into the appropriate fields on the **Uncertainty %** screen.

---

**Note**

If the calibration gas certificate does not list the uncertainty percentages, enter the default value of 2.

---

7. Press .  
The **Cal Gas Certificate CV** screen displays.
8. Enter the Cal Gas Certificate CV and CV Check Deviation values from the calibration gas certificate.

---

**Note**

The gas chromatograph (GC) calculates the energy content using the C6+ ratio configured in the GC at the factory. Because the energy content data on the calibration certificate is typically calculated using the energy value of the actual components in the mixture, there may be a difference between the GC's energy values and the calibration certificate's energy values. If the values don't match, enter the calculated values from the GC to ensure the energy value check during the calibration runs will not cause nuisance alarms.

---

9. Press .

**Related information**

[Advanced configuration and operation topics](#)

## 5.4.4 Calibrate the gas chromatograph (GC) for the first time

**Procedure**


1. Open the **Heater** screen.
2. Confirm that the Temperature for Heater 1 matches the Setpoint and that the Current PWM is less than 40.

---

**Note**

In colder environments the PWM may be higher than 40. If a stable temperature has not been reached three hours after the power was applied, refer to [Troubleshooting](#).

---

3. Press  to close the screen.



4. Go to **GC Control** → **Single Stream**.  
The **Start Single Stream Analysis** screen displays.

---

**Note**

You may be asked to log in first.

---


5. Select the calibration stream by clicking **Edit**, using the arrow keys to highlight **4-Cal**, and clicking **Edit** again.
6. Make sure the **Purge Stream for 60 seconds** and the **Continuous Operation** check boxes are selected.
7. Press  to start the analysis.
8. Press  to return to the **Home** screen.

---

**Note**

The first few analysis runs show a chromatogram on the **Home** screen that may not look normal. This is common for the first runs after the unit has been started up after an extended amount of down time.

---


9. Let the analysis run for 30 minutes and then go to **GC Control** → **Halt**.
10. Wait for the analysis cycle to finish and the mode to change to Idle.
11. Go to **GC Control** → **Calibration**.  
The **Start Calibration** screen displays.
12. Make sure the **Purge Stream for 60 seconds** and the **Normal** check boxes are selected.
13. Press  to start the calibration.
14. Wait for the calibration cycle to complete.  
By default, this will run for three analysis cycles.

---

**Note**

If the calibration generated any alarms, go to the **Current Alarms** screen to view them. Refer to [Troubleshooting](#) to learn how to resolve calibration issues.

---

15. Open the isolation valves for the sample stream(s) and set the pressure to 20 psig (1.4 barg).
16. Go to **GC Control** → **Auto Sequence**.  
The **Start Auto Sequence** screen displays.
17. Ensure that the **Purge Stream for 60 seconds** check box is selected.
18. Press  to start the analysis.
19. Go to **View** → **Reports**.  
The **Report Display** screen displays.
20. View the analysis report for each stream and confirm that the un-normalized total is between 98 and 102.  
If it is not, refer to [Troubleshooting](#).

The GC is now running and analyzing the sample streams. It automatically calibrates once a day with the default settings, so the calibration gas must remain on.

**Related information**

[Advanced configuration and operation topics](#)




## 5.4.5 Configure the gas chromatograph's (GC's) Ethernet ports

### Procedure

1. From the **Main Menu**, go to **Application** → **TCP/IP**.  
The **TCP/IP** screen displays.
2. Make a note of the Ethernet settings for both ports.  
Ethernet 1 is the RJ-45 terminal that is commonly used for local computer access; Ethernet 2 is the port that is commonly used for communication with a supervisory system, such as a flow computer, remote terminal unit (RTU), supervisory control and data acquisition (SCADA) system, or distributed control system (DCS).
3. Enter the Ethernet settings according to the network requirements of your installation.  
If you intend to use Ethernet 1 for local access only, do not change the settings. Contact your network administrator or the person in charge of configuring your supervisory system network for the settings required to connect the GC to your network.

## 5.4.6 Acknowledge an alarm

### Procedure

1. Go to the **Current Alarm** screen in one of two ways:
  - From the **Home** screen, press **2**.
  - From the **Main Menu**, go to **View** → **Current Alarms**.
2. From the **Current Alarms** screen, use **Up** and **Down** to move to the alarm that you want to acknowledge.
3. Press .

The alarm is acknowledged.

## 5.4.7 Acknowledge all alarms

### Procedure

1. Go to the **Current Alarms** screen in one of two ways:
  - From the **Home** screen, press **2**.
  - From the **Main Menu**, go to **View** → **Current Alarms**.
2. Press **1**.

All alarms are acknowledged.

## 5.4.8 Acknowledge and clear all alarms

### Procedure




1. Go to the **Current Alarms** screen in one of two ways:
  - From the **Home** screen, press **2**.
  - From the **Main Menu**, go to **View** → **Current Alarms**.

2. Press **2**.

The alarms are acknowledged and cleared from the gas chromatograph (GC) and the screen.

## 5.4.9 View the Maintenance Log




### Procedure

1. Go to the **Main Menu** in one of two ways:
  - From the **Home** screen, press .
  - From any other screen, press .
2. From the **Main Menu** screen, go to **Logs** → **Maintenance Log**.
3. Press .

The **Maintenance Log** screen displays.

## 5.4.10 View the Event Log

### Procedure

1. Go to the **Main Menu** in one of two ways:
  - From the **Home** screen, press .
  - From any other screen, press .
2. Go to **Logs** → **Event Log**.
3. Press .

The **Event Log** screen displays.

## 5.4.11 View a live chromatogram



Live chromatograms display on the **Home** screen by default, but there are two other ways of viewing a live chromatogram on its own screen.

### Method #1



From the **Home** screen, press **4** on the keypad. The **Live CGM** screen displays.

### Method #2

#### Procedure





1. Go to the **Main Menu** screen in one of two ways:
  - From the **Home** screen, press .
  - From any other screen, press .

The **Main Menu** displays with the **View** menu selected.

2. Go to **View** → **Chromatogram**.
3. Press .  
The **CGM Settings** screen displays. The live chromatogram is at the top of the list and has an icon beside it.
4. Press .  
The **Live CGM** screen displays.
5. Press **Edit** to zoom, change the cursor, hide the baseline, change the scale, or see results.
6. Use the **Up** or **Down** key to highlight an option.
7. Press **Enter** to select the highlighted option.




## 5.4.12 View an archived chromatogram

### Procedure

1. Go to the **Main Menu** screen in one of two ways:
  - From the **Home** screen, press .
  - From any other screen, press .The **Main Menu** displays with the **View** menu selected.
2. Go to **View** → **Chromatogram**.
3. Press .  
The **CGM Settings** screen displays.
4. Press **Down** to move from the live chromatogram and to select the archived chromatogram that you want to display.
5. Press .  
The **Archived CGM** screen displays.
6. Press **Edit** to zoom, change the cursor, hide the baseline, change the scale, or see results.
7. Use **Up** or **Down** to highlight an option.
8. Press **Enter** to select the highlighted option.




## 5.4.13 Start a single stream analysis run

### Procedure

1. Go to the **Main Menu** screen in one of two ways:
  - From the **Home** screen, press .
  - From any other screen, press .
2. Go to **GC Control** → **Single Stream**.
3. Press .  
The **Start Single Stream Analysis** screen displays.
4. Press **Down** to highlight the stream that you want to analyze.






The **Purge stream for 60 seconds** feature allows sample gas to flow through the sample loop for 60 seconds prior to beginning the first analysis. The feature is checked by default.

The **Continuous operation** feature allows for the repeated analysis of the selected stream. The feature is checked by default.

5. To select or clear the **Purge stream for 60 seconds** check box or the **Continuous operation** check box, do the following:
  - a) Press **Down** to move from the Stream list box to the **Purge stream for 60 seconds** check box.
  - b) To select or clear the **Purge stream for 60 seconds** check box, press .
  - c) Press **Down** to move from the **Purge stream for 60 seconds** check box to the **Continuous operation** check box.
  - d) To select or clear the **Continuous operation** check box, press .
6. Press  to start the analysis run.

## 5.4.14 Start a calibration analysis run



### Procedure

1. Go to the **Main Menu** in one of two ways:
  - From the **Home** screen, press .
  - From any other screen, press .
2. Go to **GC Control** → **Calibration**.
3. Press .
4. Press .
5. Press .

The **Purge stream for 60 seconds** feature allows sample gas to flow through the sample loop for 60 seconds prior to beginning the first analysis. The feature is checked by default.

There are two types of calibration:

- Normal calibration is a manual calibration in which the newly computed calibration factors are updated to the component data table (CDT) **only if** the deviation with previous factors don't exceed limits set in the CDT. This is the default option.
  - Forced calibration is a manual calibration in which the component data table for the selected stream is updated with calibration factors **even if** that data is outside the acceptable deviations that are listed in the CDT.
6. To select or clear the **Purge stream for 60 seconds** check box, do the following:
    - a) Press **Down** to move from the **Stream** dropdown list to the **Purge stream for 60 seconds** check box.

- b) To select or clear the **Purge stream for 60 seconds** check box, press .
  - c) If you do not want to select a calibration type, press .  
The calibration starts.
7. To select a calibration type, do the following:
- a) Press **Down** to move from the **Purge stream for 60 seconds** check box to the set of Calibration Type check boxes.  
The **Normal** check box is selected.
  - b) If you want to select **Forced**, press **Down**.
  - c) Press - (hyphen) to start the calibration run.

## 5.5 Advanced configuration and operation topics

### 5.5.1 Validation

You can configure the gas chromatograph (GC) to validate an analysis of the calibration standard (or another stream) to ensure that the analysis is within specified limits.

You can configure the validation for any of the streams, including the calibration stream (default). You can configure the validation to run automatically at a set time and frequency, or you can initiate it manually.

In previous generations of GCs, operators ran a daily calibration to verify the correct operation and to account for changes in measurement on a daily basis. They would typically configure a calibration run to run for three analysis cycles of the calibration gas; the calibration run changes the response factors.

The main advantage of the validation is to confirm the analysis is within specifications without changing the calibration factors.

#### Prepare for a validation

Before starting a validation run you must configure the stream that you intend to use as the validation stream.

The gas chromatograph (GC) allows you to assign virtual streams to any of its stream selection solenoids. By default, the fifth stream is configured as the validation stream.

#### Procedure

1. Start Rosemount MON2020 and go to **Application** → **Streams**.  
The **Streams** window opens.
2. Enter the Total Runs and Avg (Average) Runs for the validation cycle.  
The Total Runs is the number of analysis cycles that will be run in total. The Avg Runs is the number of runs that are used to average and then validate the data. For example, if the Total Runs is 3, and the Avg Runs is 2, the validation cycle analyzes the validation streams for three cycles, and the last two cycles are used to average the results and validate the measured values. By default, both are configured for one run only.
3. Select the physical stream in the **Stream Valve** column that will be used for the validation gas.
  - If validating against the calibration gas, select **Calibration** from the **Stream Valve** drop-down list.

- If validating with a gas other than the calibration gas on a single-stream GC, select **Calibration** from the **Stream Valve** drop-down list and install a manual three-way valve before the calibration inlet on the sample conditioning system.
  - If validating with a gas other than the calibration gas on one of the streams of a multi-stream GC, select the appropriate stream valve from the **Stream Valve** drop-down list.
4. If you are using the calibration gas, or if the validation gas is permanently installed and you want to run a validation on a schedule, do the following:
    - a) Select the check box in the appropriate Auto column.
    - b) Select the Start Time for the first validation.
    - c) Enter the Interval, in hours, between validation runs.

---

**Note**

If you are configuring an auto-validation and an auto-calibration, schedule the validation run to occur at least 30 minutes before the calibration run to provide a validation of the measurement just before the calibration cycle re-calculates the response factors.

---

5. Click **OK** to save the data and close the **Streams** window.
6. Go to **Application** → **Validation Data**.  
The **Validation Data** window opens.

---

**Note**

The **Validation Data** command is not available on the **Application** menu unless at least one stream is assigned to Validate in the Usage column in the **Streams** window.

---

7. Select the variables to be validated and enter the Nominal Value and the Percent Deviation for each.

---

**Note**

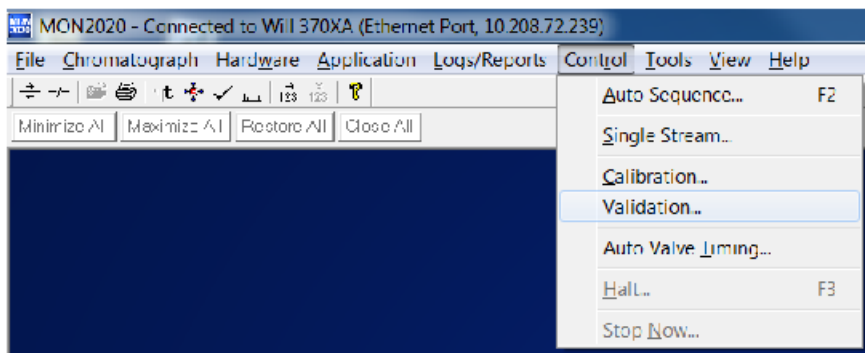
When entering variables, if you want to enter the next component from the component data table based on the previously entered component, click **C+Copy (F8)**.

---

## Run a validation

Once the validation settings have been configured, the validation cycle begins at the scheduled time if the gas chromatograph (GC) is in Auto mode.

You can also start a validation cycle by going to **Control** → **Validation** in Rosemount MON2020.



---

#### Note

You can generate a validation report at any time by going to **Main Menu** → **View** → **Report Display** from the local operator interface (LOI) or **Logs/Reports** → **Report Display** from Rosemount MON2020.

---

## 5.5.2 Change the calibration gas

Changing the calibration gas is a very critical procedure that can significantly affect the accuracy of the gas chromatograph (GC) if not performed correctly.

Before using a new calibration gas blend for calibrating the GC, you must verify the composition stated on the certificate by using the Rosemount 470XA to analyze the new calibration gas.

#### Procedure

1. Go to **Tools** → **Change Cal Cylinder**.  
The **Calibration Cylinder Replacement Assistant** screen displays.
2. Follow the software assistant's prompts.

---

#### Note

On step 6, enter the calibration gas concentrations. You can obtain these from the bottle certificate. The screen auto calculates the methane value if the **Auto Calculate Methane** check box is selected. If the calibration gas's certificate displays a methane value, compare the value to the screen's methane value. If the values do not match, confirm that you have entered the other values correctly.

---

#### Note

If the certificate states an uncertainty percentage for each component, enter them on step 7. If the certificate does not show the uncertainty percentages, then use the default value of 2%. The uncertainty values can be used to confirm that the analysis of the calibration gas matches the certificate values before the standard is used to calibrate the GC.

---

#### Note

If the certificate includes the energy content, enter it on step 8. If the certificate does not include an energy content, use the calculated energy content shown.

---

After you have followed all of the assistant's prompts, it analyzes the calibration gas and repeats the analysis until the nitrogen value repeats within the uncertainty value entered on a previous screen. Because air is 78 percent nitrogen, and the calibration gas contains significantly less nitrogen than this, the analyzed nitrogen content should typically start high and then decrease as the system is purged with the new gas. The screen displays

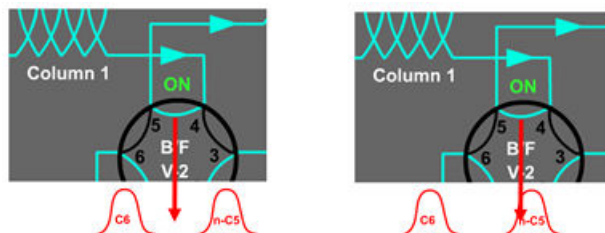
the nitrogen value for each run on the table to the left of the chromatogram. Once the nitrogen value has stabilized, the last analysis is compared to the entered certificate values to ensure that the GC is analyzing accurately.

### 5.5.3 Auto valve timing

The analytical valves in the oven are switched on or off during the analysis cycle to change the analytical flow path to separate certain components through particular columns. For the C6+ analysis, column one separates the hexane and heavier components (C6+) from the pentane and lighter components; column two separates the propane to pentane components; and column three separates the nitrogen, methane, carbon dioxide, and ethane. The timing of the valve switching is critical to the accurate performance of the analysis.

Over time, the resistance to flow and the performance of the columns changes, resulting in the switching of the valves cutting into some of the component, rather than switching between the peaks as they elute from a column.

**Figure 5-10: Timing of valve switching**



This image shows two different times for switching the valves when two components are eluting from a column. The example on the left shows the ideal time between the two peaks. The example on the right shows the valve timing is too early, and will result in the exclusion of some of the normal-pentane.

Traditionally, highly trained gas chromatograph (GC) experts would manually adjust the valve timing and tune the timing of the integration events occasionally to account for the small changes in retention times and measurement issues.

Auto valve timing (AVT) automates this process so that even an inexperienced operator can initiate an adjustment of the valve timing, letting the GC's internal algorithm adjust and optimize the valve timing automatically.

To initiate AVT in either the local operator interface (LOI) or Rosemount MON2020, go to **Control** → **Auto Valve Timing**.

The AVT uses the calibration stream to make adjustments. The configuration selection provides options for the starting point for the adjustments:

- Use Factory Defaults** The AVT algorithm starts using the factory default values loaded into the module when the module was originally built. Use this option when maintenance has been performed on the module; for example, the analysis valve diaphragms have been overhauled, and the retention times have significantly changed from the last calibration.
- Use Current** The AVT algorithm will start using the valve timing and integration settings currently in the module.



## 5.5.4 Warm-start mode

When power is reinstated after being lost while the gas chromatograph (GC) is in Auto-analysis mode, the GC enters Warm-start mode and tries to go back on line.

In Warm-start mode, the GC monitors the oven temperature until it is stabilized at the set point, runs calibration gas, and checks that all of the components are detected correctly. Once the calibration gas has been analyzed correctly, the GC re-enters Auto-analysis mode.

If the Warm-start mode fails to complete within two hours, a **Warm-start failure** alarm is triggered, and the GC goes into Idle mode.

## 5.5.5 Maintenance mode

Maintenance mode allows you to work on the gas chromatograph (GC) while alerting the supervisory system that the current analysis may not be valid and should not be used.

Maintenance mode triggers a system alarm that can be read as a Modbus<sup>®</sup> Register (bit 0 on Register 3046 in the *SIM\_2251 Modbus* map) and on the **Common Alarm** digital output.

To enable Maintenance mode in either the local operator interface (LOI) or Rosemount MON2020, go to **Application** → **System**.

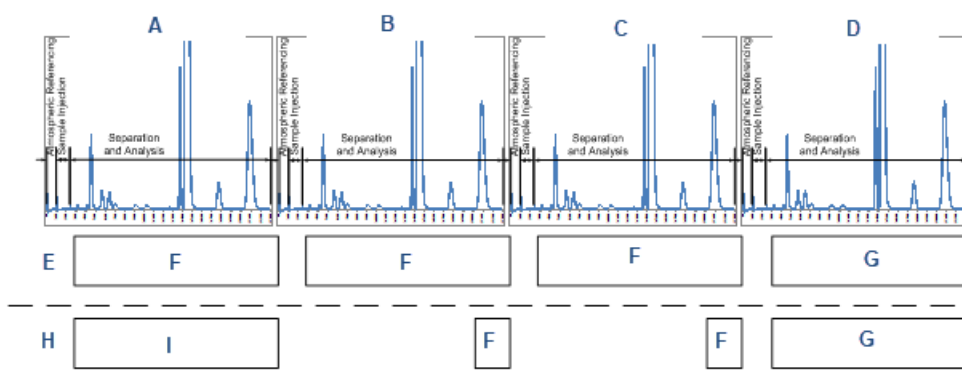
When Maintenance mode is active, the analysis in the Modbus registers is still updated so that communication to the supervisory system can be tested; however, the analysis results during Maintenance mode are not included in the averages calculated by the GC.

## 5.5.6 Conserve calibration gas

To save calibration gas, the Rosemount 470XA has a unique feature called Cal-Gas Saver that reduces calibration gas usage significantly.

During normal operations, the next stream will start to be purged through the sample loop from when the sample shut-off valve that is operated by the back-flush valve timing at around 25 seconds is opened, through to the start of the next analysis. This ensures that the sample lines and the sample loop are completely purged of the previous stream and the sample loop is full of the next sample to be analyzed.

Figure 5-11: Cal-Gas Saver



- A. Sample stream analysis
- B. Calibration gas cycle 1
- C. Calibration gas cycle 2
- D. Calibration gas cycle 3
- E. Purge flows without Cal-Gas Saver
- F. Calibration gas purge
- G. Sample stream purge
- H. Purge flows with Cal-Gas Saver
- I. Initial calibration gas purge

A calibration cycle involves running multiple analysis cycles of the calibration gas. Because there are multiple runs of the same gas, there is no need to purge the sample lines leading up to the sample loop after the first analysis run. To conserve the amount of calibration gas used by the gas chromatograph (GC) while still maintaining calibration accuracy, the Cal-Gas Saver feature turns off the calibration gas stream for a longer period during the calibration gas analysis cycles to dramatically reduce the amount of calibration gas consumed.

Figure 5-12: Valve Events screen showing Cal Gas Save events

Valve Events				
	Type	Valve/DO #	State	Time
				SEC
1	Valve #	2 - BF	On	0.3
2	Valve #	3 - DC	On	2.0
3	Valve #	1 - SV	On	5.0
4	Strm Sw			7.0
5	Valve #	1 - SV	Off	10.0
6	Cal Gas Save		On	20
7	Valve #	3 - DC	Off	42.0
8	Valve #	3 - DC	On	130.0
9	Cal Gas Save		Off	200

Sort    Delete    Insert After    S

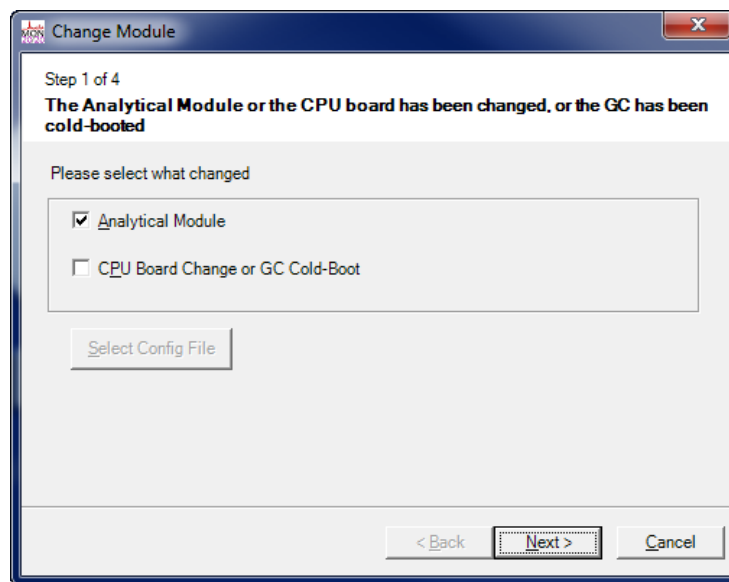
By default, the Cal-Gas Saver is switched on at 20 seconds and turned off at 200 seconds, but you can change these values.

1. Start Rosemount MON2020 and go to **Application** → **Timed Events**. The **Timed Events** screen opens.
2. Locate the first Cal Gas Save event on the **Valve Events** table. This event switches on the Cal-Gas Saver feature.
3. Enter a new start time in the appropriate Time field.
4. Locate the second Cal Gas Save event on the **Valve Events** table. This event switches the Cal-Gas Saver feature off.
5. Enter a new end time in the appropriate Time field.
6. Click **OK** to save the changes and close the screen.

## 5.5.7 New Module software assistant

When you install a new analytical module on the Rosemount 470XA and turn on the power, the gas chromatograph (GC) recognizes that a new module has been installed and starts the **New Module** software assistant, which heats up the oven, runs carrier gas through the analytical paths, and cycles the analytical valves to rapidly purge the system.

Figure 5-13: New Module software assistant



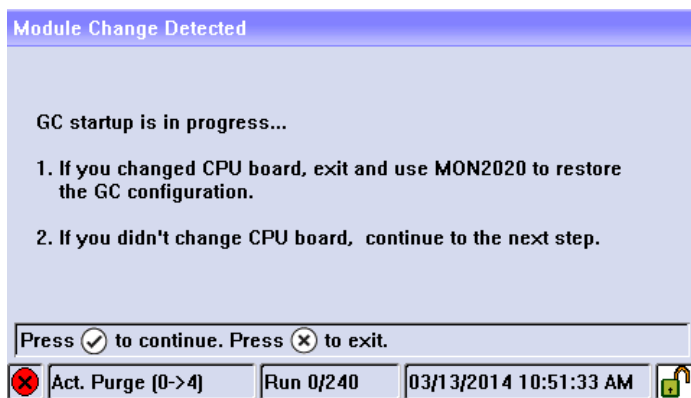
### Note

You can initiate the **New Module** software assistant from the local operator interface (LOI) or Rosemount MON2020 by going to **Tools** → **Module Validation**.

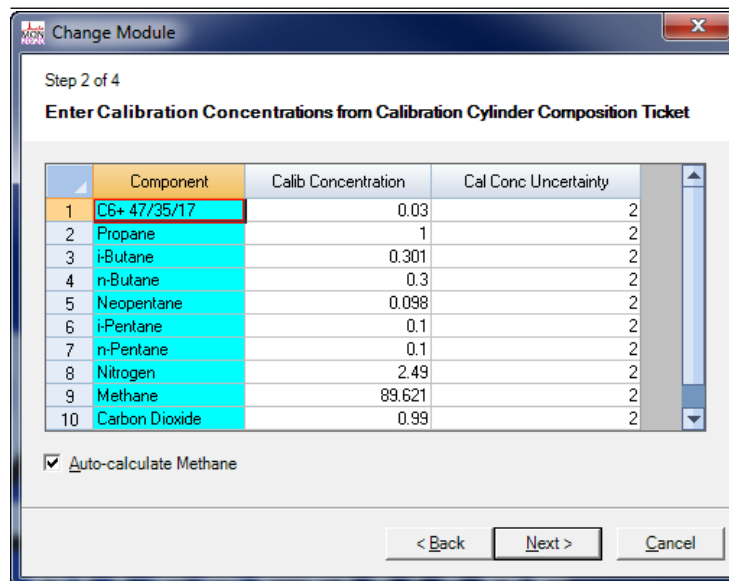
### Note

Changing the central processing unit (CPU) board will also start the **New Module** software assistant because of the mismatch between the CPU board and the analytical module. In

this case, you should stop the assistant by pressing .



While the GC is heating up to temperature, the LOI shows the **Enter Calibration Concentrations from Calibration Cylinder Composition Ticket** screen so that you can confirm that the module's calibration gas values match the concentrations and the uncertainty on the calibration gas bottle certificate.



When the oven temperature has stabilized, the software assistant automatically runs the calibration gas and validates the module. The validation runs three analysis cycles of calibration gas and confirms that the analysis is within the pre-configured specifications. If the analysis is within the specifications, a calibration cycle is then run. If the analysis is not within the specifications, a **Module Validation Fail** alarm is raised, and the GC goes into Idle mode.

After the calibration cycle is completed, the GC goes into Auto mode and begins analyzing the stream gas.

## 6 Preventative maintenance

Emerson recommends calibrating the gas chromatograph (GC) daily and reviewing GC performance (repeatability, total unnormalized, n-pentane retention times, and ethane retention times) monthly.

### 6.1 Save diagnostic data

At least every other month, create and save a diagnostic data file and check carrier and calibration gas supplies.

Fill out a **Maintenance** checklist.

### 6.2 Set up auto-calibration in software

#### Procedure

Set up the gas chromatograph (GC) to run auto-calibration daily in order to update response factors and retention times.

### 6.3 Display trend data

The data to plot the trend graphs displays in the table to the right of the graph display area.

The **Trend Data** table contains the following columns:

**Pt #** For the purposes of trend graphs, each sample run is considered a data point. Therefore, if 2500 sample runs were used to generate the trend graph, then there are 2500 data points.

---

#### Note

The first sample, or point, is counted as  $0$ , not  $1$ . The final point is counted as  $N - 1$ , where  $N$  is the total number of points in the graph.

---

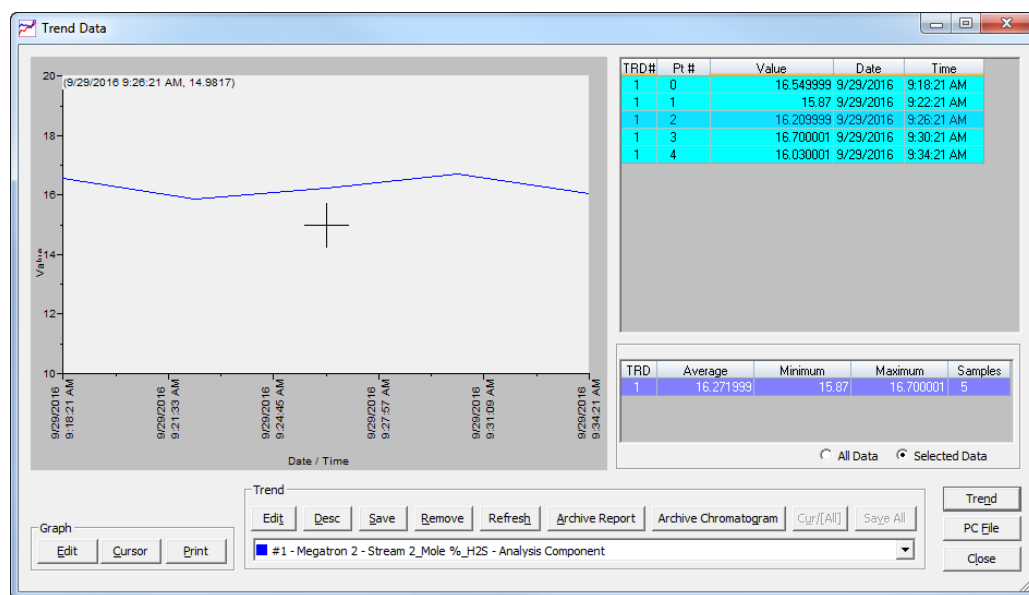
**Value** The data point's value.

**Time** The gas chromatograph (GC's) time when the sample was run and the value was calculated.

To view all trend data, click **Cur/All**. To view trend data for the trend graph selected from the Trend drop-down list, click **Cur/All** again.

The second trend data table is useful when zooming in to or out of the graph. When the **Selected Data** check box is selected, this table displays the trend data for the visible area of the graph. As the example shows, the table indicates that the trend data for five samples are visible after zooming in to the graph.

Figure 6-1: Trend Data screen



### Procedure

1. Click **Trend** to configure the parameters for a trend file.
2. Click **PC File** to display the **Open Trend File** dialog and navigate to a saved file on your personal computer (PC).
3. Click **Close** to exit the **Trend Data** screen and return to the home page.

## 6.4 Configure the valve timing

### Related information

Auto Valve Timing (AVT) screen

# 7 Replacing the Maintainable Module

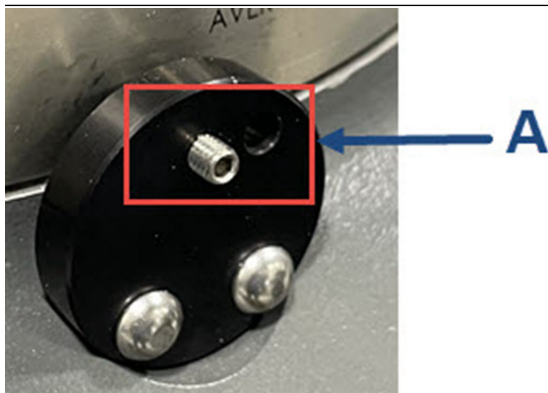
## 7.1 Remove the Maintainable Module

### Tools required

- 2 mm hex or Allen wrench
- 4 mm hex or Allen wrench
- Two flat head screwdrivers
- Two ¼-in. wrenches

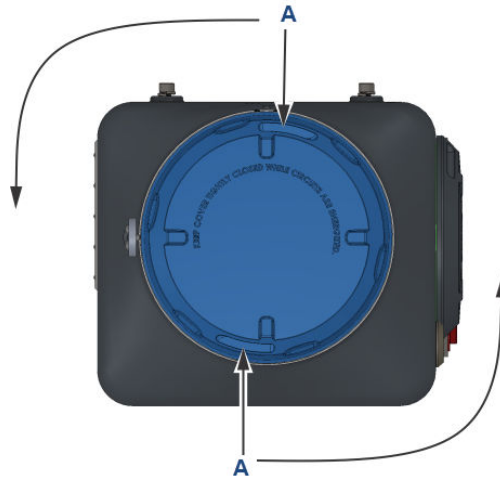
### Procedure

1. Disconnect power from the gas chromatograph (GC).
2. Turn off the sample gas(es) at the isolation valve(s) in the external sample system closest to the GC.
3. Turn off the calibration gas at the isolation valve closest to the GC.
4. Turn off the carrier and actuation gases at the isolation valve closest to the GC.
5. Use a 2 mm hex wrench to loosen the dome locking screw located on the left side of the GC above the gas lines.



A. Dome locking screw

6. Unscrew the dome.  
If the dome is too tight, insert two screwdrivers or similar tools into the grooves at the top rim of the dome to provide additional leverage when twisting the dome.



A. Grooves

## NOTICE

The grooves are designed to aid you in loosening the dome.  
Do not try to use them to tighten the dome.

## ⚠ WARNING

You may hear a short hiss, as some of the trapped carrier and sample gases are released.

If the hissing sound continues for more than a few seconds, confirm that the sample, calibration, carrier, and actuation gases are isolated.

7. Remove the insulation cap.

## ⚠ WARNING

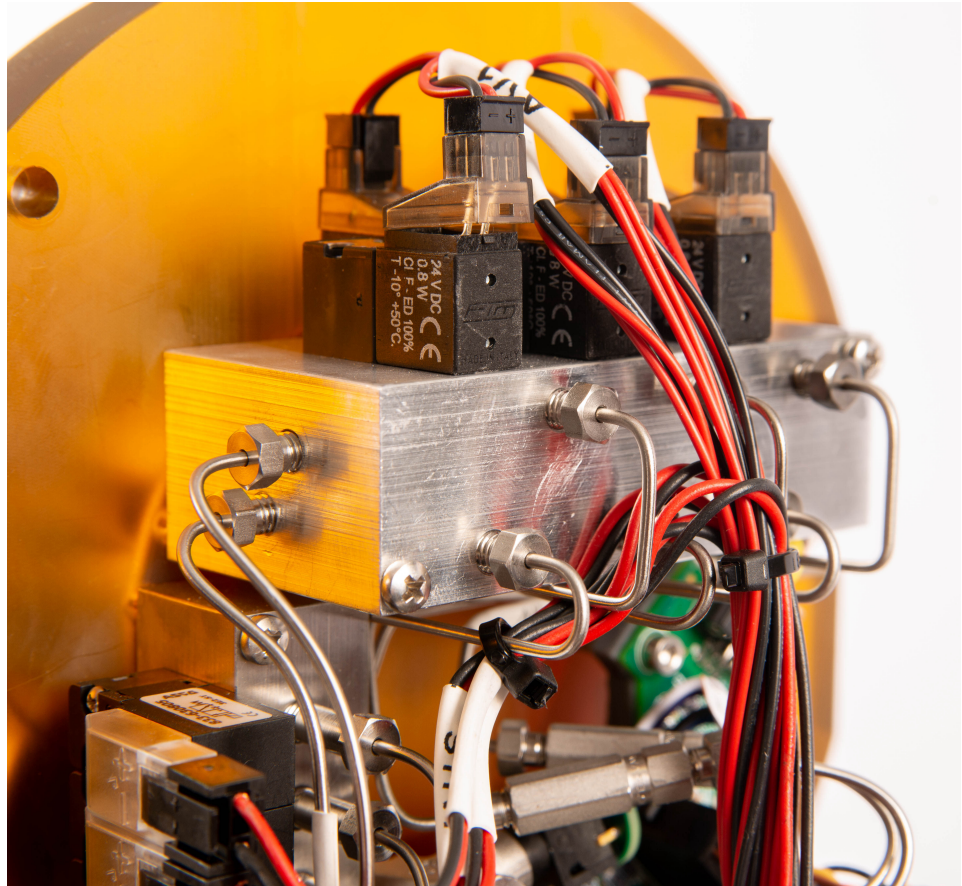
### Hot surface

The oven is approximately 176 °F (80 °C) and hot to the touch.

8. Loosen the three hex screws holding the module to the base.
9. Remove the three hex screws.
10. Grip the module base and carefully lift it off its housing.

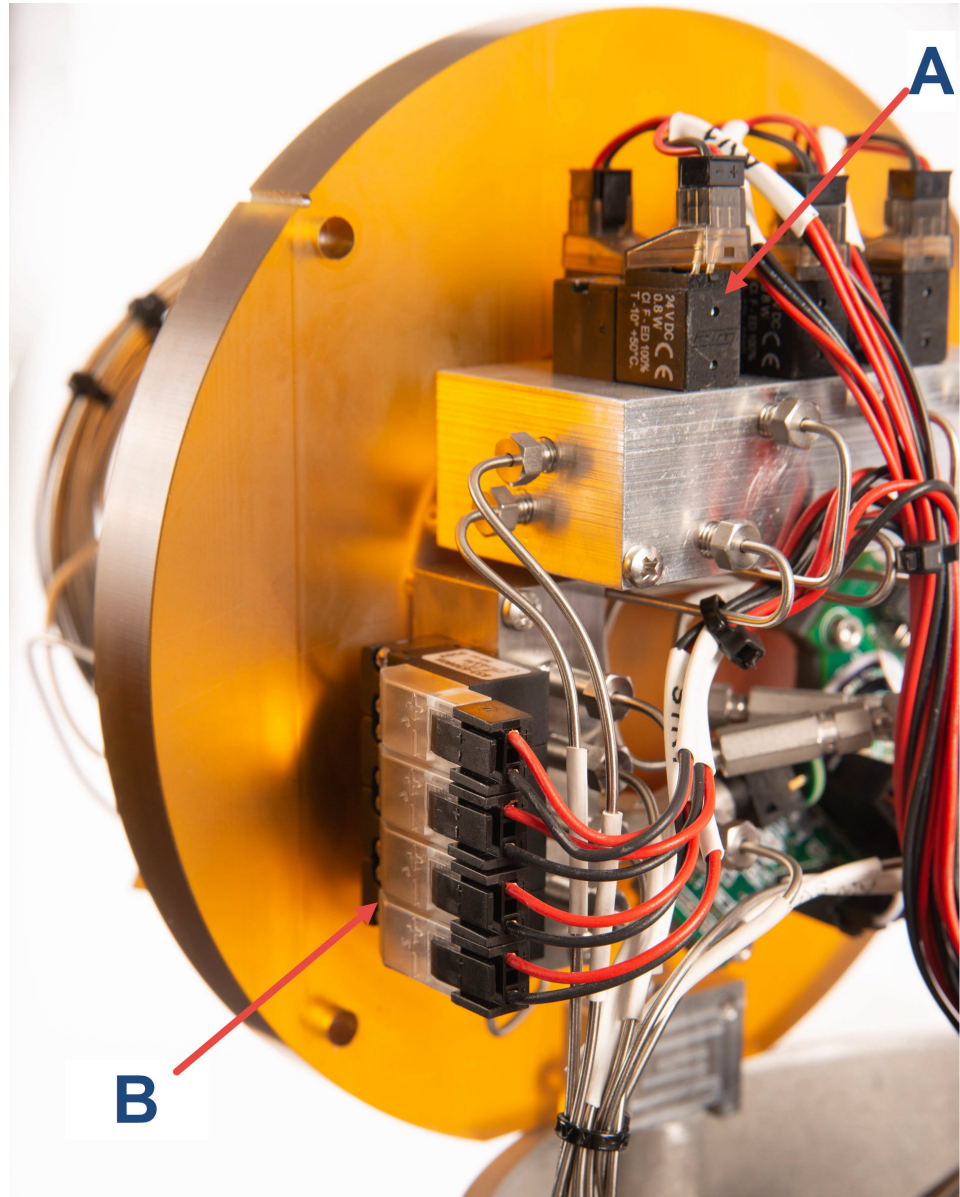


11. Tilt the module and attach it to the post.



12. Disconnect the wiring from the heater, intelligent module board (IMB), and solenoids.

**Figure 7-1: Solenoids**



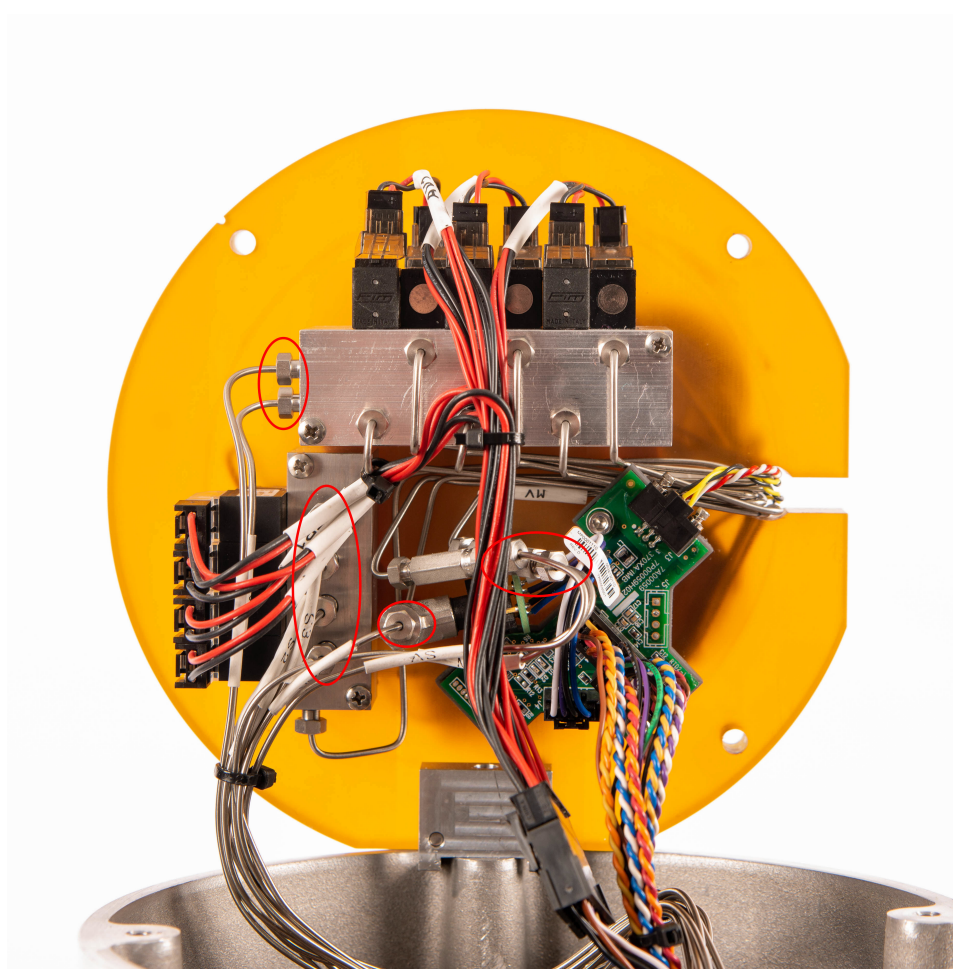
*A. Valve actuation solenoids  
B. Stream switching solenoids*

13. Disconnect the Swagelok® fittings.

**Note**

A gas GC using helium carrier gas has 9 Swagelok fittings.  
A GC using hydrogen carrier gas has 13 Swagelok fittings.

**Figure 7-2: Swagelok fittings**



14. Remove the module from the post.

## 7.2 Install a Maintainable Module

### Prerequisites

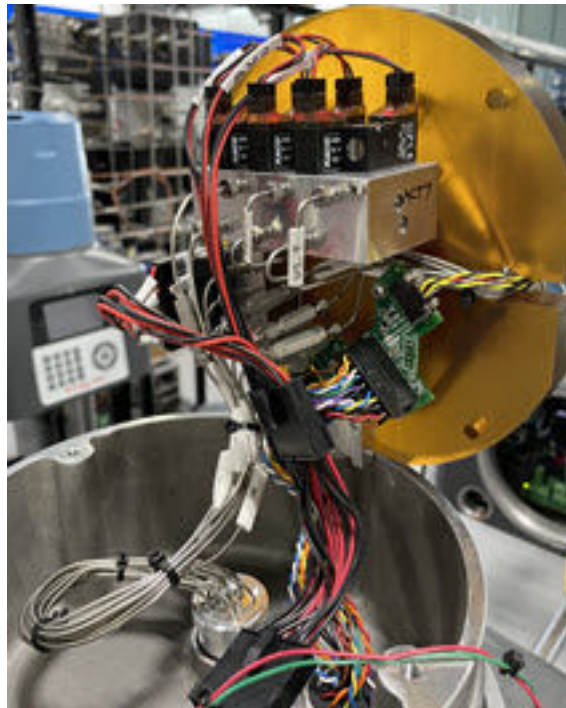
Parts required	<ul style="list-style-type: none"><li>• Analytical module</li><li>• Swagelok® fittings<ul style="list-style-type: none"><li>— 11 if using helium carrier gas</li><li>— 13 if using hydrogen carrier gas</li></ul></li></ul>
----------------	---

Tools required	<ul style="list-style-type: none"><li>• 5 mm hex or Allen wrench.</li><li>• Two ¼-in. wrenches</li><li>• One ⅜-in. wrench</li></ul>
----------------	---

Ensure that the power remains off, the various gases continue to be isolated external to the analyzer, and the dome remains off.

### Procedure

1. Uncap the Swagelok fittings.
2. Attach the dome to the housing and ensure that the tubing is attached correctly.

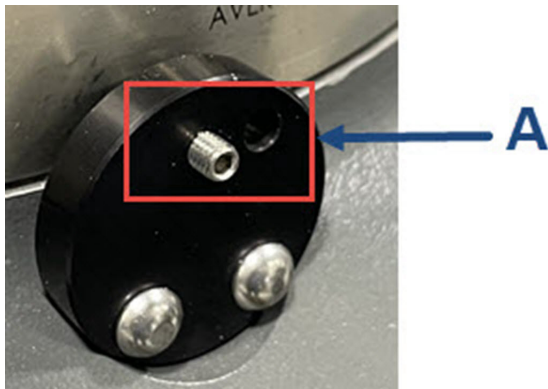


3. Connect the solenoid electrical connector to the male connector leading to the solenoids.
4. Connect the male 18-pin signal connector to the connector on the intelligent module board (IMB) circuit board.
5. Connect the two-pin heater connectors.
6. Align the groove on the module base to the front of the analyzer and lower the module down onto the guide pins on the spring-loaded feed-through.
7. Turn the module 45 degrees.
8. Place the insulation cap over the heater cap.
9. Open the actuation gas isolation valve.
10. Using the pressure regulator, set the gas pressure to the factory specifications.
11. Tighten the three mounting screws on the module.

12. Use the Allen wrench to tighten the dome locking screw.

---

**Figure 7-3: Dome locking screw**



*A. Dome locking screw*

---

13. Power up the gas chromatograph (GC).

After the firmware starts running, the GC checks the serial number of the new module to determine if it matches the serial number of the module that was in place when the GC was shut down. If it does not, the analyzer starts the **New Module** software assistant. If the serial numbers do match, the analyzer warms up and stays in Idle mode.



## 8 Repairing and maintaining the valves

The valves require minimal repair and maintenance, such as replacing the diaphragms.

### 8.1 Required tools for valve maintenance

The tools required for performing repair and general maintenance on the Rosemount XA Series valve assemblies are:

- Torque wrench, scaled in foot-pounds
- 7/16-in. socket for 6-port valves
- ¼-in. open-ended wrench
- 5/16-in. open-ended wrench
- 5/32-in. Allen wrench

### 8.2 Overhaul a valve

#### Prerequisites

Replacement part required: Diaphragm 6-port XA Valve (9A00096G01)

#### Note

Rosemount valves have a lifetime warranty. Replacement factory-built XA Series valves are available. Call your local Emerson Customer Care representative for more information.

**Figure 8-1: Valve with diaphragm kit**



If you are overhauling a six-port valve, refer to drawing #CE-22260.

### Procedure

1. Shut off the carrier and sample gas streams entering the unit.

#### **⚠ WARNING**

##### **Burns**

To prevent burns, do not touch any of the hot parts. All parts of an analyzer are always hot unless it has been switched off and allowed to cool down.

Before fitting, removing, or performing any maintenance on the analyzer, make sure that it has been switched off and allowed to cool for at least two hours.

When handling the analyzer, always use suitable protective gloves.

These precautions are particularly important when working at heights.

If burned, seek medical treatment immediately.

2. Disconnect tubing and fittings that attach to the valve from other locations.
3. Loosen the valve's torque bolt.  
See Drawing CE-22260.
4. Holding the lower piston plate, pull the valve straight off the block.  
The alignment pins may stick slightly.
5. Remove and discard the old valve diaphragms and gaskets.
6. Clean the sealing surface as required using a non-lint-forming cloth and isopropyl alcohol. Blow the sealing surface with clean, dry instrument air or carrier gas.

#### **NOTICE**

Dirt, including dust and lint, can cause troublesome leakage.  
Do not use an oil-based cleaner on the valve.

7. Replace the old diaphragms and gaskets, in the same order, with the new ones supplied.
8. Reassemble the valve using the following steps:
  - a) Align the pins with holes in the block and push the valve assembly into place.
  - b) Tighten the valve's torque bolt.  
The six-port valve requires 20 ft.-lb. of torque.
  - c) Reinstall the valve using the two mounting screws and reconnect all fittings and tubing.



## 8.3 Replace solenoids

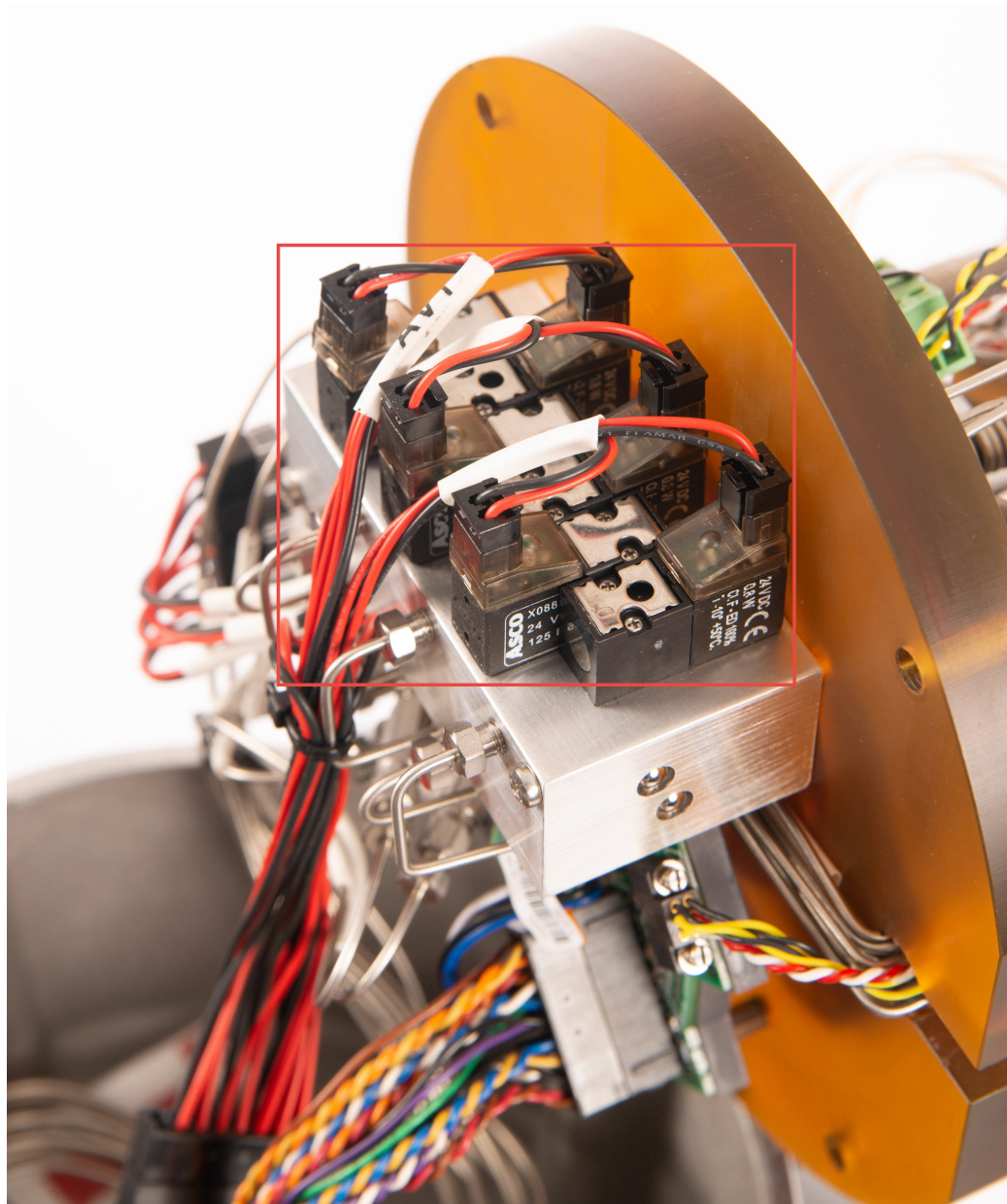
You can replace the oven system solenoids and/or the stream switching solenoids.

### **⚠ WARNING**

#### **Explosion**

- Do not open when energized or when an explosive atmosphere is present.
  - Keep cover tight while circuits are live.
  - Use cables or wires suitable for the marked "T" ratings.
  - Cover joints must be cleaned before replacing the cover.
  - Ensure that conduit runs have a sealing fitting adjacent to the enclosure.
  - Use supply cables or wires suitable for at least 176 °F (80 °C).
-

Figure 8-2: Solenoids



### Prerequisites

Required tools:

- 5/32-in. allen wrench
- Phillips head screwdriver #1

### Procedure

1. Loosen the screws holding the solenoid in place and remove the solenoid.
2. Place the new solenoid.

3. Tighten the screws to hold the solenoid in place.
4. Place the oven upright.



# 9 Troubleshooting

## 9.1 Alarms

The following alarms may appear on the Rosemount 470XA .

### 9.1.1 Maintenance Mode

The Maintenance mode is on. The flag in the Modbus® map for Maintenance mode is switched on, and the discrete output for activating the common alarm (if configured) is on.

#### Recommended action

Refer to [Maintenance mode](#) for more information.

### 9.1.2 Power Failure

The 24 Vdc power supply to the gas chromatograph (GC) failed.

---

#### Note

The SET time indicates the time power was restored to the GC.

---

#### Recommended action

To determine when the power was lost, look at the time of the last analysis before the power fail occurred.

### 9.1.3 User Calculation Failure

An error occurred in one of the user-defined calculations.

#### Recommended action

Check the user calculations for divide by zero errors or for incorrect references.

### 9.1.4 Low Battery Voltage

The central processing unit (CPU) battery voltage is low.

#### Recommended action

The battery is soldered onto the CPU board; contact the factory to replace the CPU board.

### 9.1.5 Stream Skipped

There was an error in stream sequencing that resulted in failure to analyze one of the streams in the stream sequence. This alarm will occur if someone switches the stream's usage to Unused without removing the stream from the stream sequence.

#### Recommended actions

1. In Rosemount MON2020, go to **Application** → **Stream Sequence**.
2. Delete the unused stream from the sequence.

## 9.1.6 GC Idle

The analysis mode was switched to GC Idle, and there was no connection to a Rosemount MON2020 software session. If you change the mode to GC Idle while Rosemount MON2020 is connected, this alarm is not generated. If you change the mode to GC Idle in the local operator interface (LOI) or the gas chromatograph (GC) is in GC Idle mode when you disconnect from Rosemount MON2020, this alarm is active.

## 9.1.7 Warm Start Failed

The GC has failed to return to Analysis mode after a power failure. If the GC is in Auto Analysis mode and the power is lost, when the power is reapplied, the GC heats up and analyzes calibration gas until it identifies all the component peaks. After all the peaks are identified and the analysis is good, the GC goes back into Auto Analysis mode. However, if the peaks are not identified within the time period indicated in the Max Warm Start Delay field in the **System** window, the GC raises the **Warm Start Failed** alarm, goes into GC Idle mode, and does not analyze stream gas.

## 9.1.8 Heater Out of Range

The analytical oven heater failed to reach the set point within 15 minutes or reads higher than the set point.

### Recommended actions

1. In Rosemount MON2020, go to **Hardware** → **Heaters**.
2. Set the Heater switch to Auto.
3. Wait for three hours and then check again.
4. Using a multimeter, measure the supply voltage at the gas chromatograph (GC) terminals with the GC running.
  - If the supply voltage is below 22 V, increase the DC supply voltage so that there are 22 V at the terminals.
  - If the supply voltage is at or above 22 V and the alarm is still on, proceed to [Step 5](#).
5. Check for leaks on the column connections in the oven.

### NOTICE

A large leak in the oven can cause a cooling effect in the oven.

- If you find leaks, stop the leaks.
  - If you don't find leaks, replace the module.
6. Remove the dome and inspect the heater cable.
    - If the cable is not connected, turn off power, connect the heater cable, and turn on the power.
    - If the cable is connected, check if the oven feels hot.
  7. Open Rosemount MON2020 and go to **Tools** → **Diagnostics**.
  8. Check if the System 22V input value is above 22 V.
    - If it is below 22 V, see [Step 4](#).

- If it is above 22 V, turn off all supply gases (carrier, calibration, and sample) and remove the dome.
9. Turn off power and remove the analytical module.
  10. Remove the RTD connector from the detector block and measure the resistance. If the resistance is between 90 and 140 ohms:
    - a) Return the RTD to the detector block and re-seat the large connector on the intelligent module board (IMB).
    - b) Turn on the GC.
      - If checking the RTD solved the problem, wait until the oven temperature is at a set point and the PWM is below 40. Then restart the analyzer.
      - If checking the RTD did not solve the problem, turn off power to the GC.
    - c) Remove the central processing unit (CPU) board and the analyzer board and inspect the two analyzer cable connectors.
    - d) Ensure that the connectors are seated correctly.
    - e) Return the boards and turn the power to the GC back on.
    - f) If fixing the connectors did not fix the problem, replace the analyzer board.
  11. Replace the backplane.
  12. Turn off power and use an ohm meter to measure the resistance at the heater.
    - If the resistance is greater than 20 ohms, there is an open circuit. Replace the heater cap.
    - If the resistance is less than 10 ohms, there is a short circuit. Replace the heater cap.
    - If the resistance is about 16 ohms, leave the heater disconnected and turn the GC back on.
  13. In Rosemount MON2020, go to **Hardware** → **Heaters**.
  14. Set the Current PWM for the heater to **100**.
  15. Set the Switch for the Heater to **Fixed On**.
  16. Measure the voltage on the heater cable.
    - If the voltage is less than 20 V, turn off the power. Remove the CPU board and the analyzer board and inspect the analyzer cable connections. Ensure that they are firmly connected to the backplane's connections. Return the boards to the back plane and reapply power. If the problem is not resolved, replace the analyzer board.
    - If the voltage is greater than 20 V, the likely cause is a loose connection. Go to **Hardware** → **Heaters**.  
Set the heater's Switch to **Auto**.  
Turn off the GC and inspect the heater cable connection. If the cable is not secure, secure it and return power to the GC. If the cable is secure, contact your Emerson Customer Service representative.

## 9.1.9 Detector (1-12) Scaling Factor Failure

The scaling factor for the high and low gain preamp channel was outside the acceptable range of values.

### Potential cause

There is a fault on the analyzer board.

### Recommended action

Replace the analyzer board.

## 9.1.10 Carrier Pressure Low

The carrier gas pressure, as measured on the carrier gas pressure sensor on the analytical module, is too low.

The carrier pressure regulator on the Rosemount 470XA measures and controls the pressure.

If the pressure does not reach the set point within 60 seconds, the `Carrier Pressure Low` or `Carrier Pressure out of Range` alarm is triggered.

### Recommended actions

1. Confirm that the regulated pressure at the bottle is at 90 psig (6.2 barg) and that the isolation valves between the bottle and the gas chromatograph (GC) are all open.
2. Ensure that the carrier pressure supply cylinder is open.
3. Set the carrier pressure to 90 psig (6.2 barg).
4. Leak check the GC between the carrier gas bottle and the tubing hub.
5. If there is a separate actuation gas, set the pressure to 90 psig (6.2 barg).
6. On the local operator interface (LOI), go to **Hardware** → **Carrier Pressure**. The **Carrier Pressure** screen shows the difference between what the carrier pressure should be and what it is. The difference should be 1-3 psig.
7. Check to see if the vent is blocked by temporarily disconnecting the vents at the hub on the left side of the GC, allowing them to vent directly.

## 9.1.11 Carrier Pressure Out Of Range

The carrier gas pressure, as measured on the carrier gas pressure sensor on the analytical module, is outside of the control limits.

### Recommended actions

1. Verify that the regulated pressure at the bottle is at 90 psig (6.2 barg).
2. If the regulated pressure is OK, check the connections on the carrier pressure control valve and the pressure sensor.
3. Refer to [Carrier Pressure Low](#) for help with troubleshooting this issue.

## 9.1.12 Analog (Input or Output) (High or Low) Signal

The value of the variable assigned to the analog output is outside the range of the analog output.



#### Recommended action

If the value is valid, re-range the analog output and the associated device that is receiving the signal so that the value of the variable is within the range.

### 9.1.13 Stream Validation Failure

#### Alert

The analysis of the validation gas for the associated stream is outside the allowable percent deviation, as defined in the **Validation Data** table.

#### Recommended actions

1. Confirm that the validation gas concentration is entered correctly in the **Validation Data** table.
2. If the concentrations are entered correctly, check the validation run analysis results and chromatogram for analysis errors.

### 9.1.14 Stream (1, 2, or 3) RF (response factor) Deviation

Streams 1 through 3 should only be set to Analysis or Unused. This alarm may occur if the streams are incorrectly configured for calibration.

#### Recommended actions

1. Start Rosemount MON2020 and go to **Application** → **Streams**.
2. Set the stream's Usage to Analysis or Unused.

### 9.1.15 Stream 4 RF (response factor) Deviation

The response factor for one or more components have changed during a calibration run by a percentage greater than that set in the component data table.

#### Recommended actions

1. Verify that the calibration gas concentration has been entered into the component data table correctly and confirm that the calibration gas bottle is not empty or isolated.
2. If the concentrations are correct, the isolation valves are open, and there is sufficient gas pressure (higher than 20 psig or 1.4 barg), check the calibration analysis and chromatograms for analytical errors.

### 9.1.16 Analyzer Board Comm Failure

The communication link between the central processing unit (CPU) board and the analyzer board has failed.

#### Recommended actions

1. Remove power and confirm the analyzer board is seated correctly on the backplane.
2. If the analyzer board is seated correctly, replace the analyzer board.
3. If replacing the analyzer board does not rectify the issue, replace the backplane board.

## 9.1.17 LOI Comm Failure

The communication link between the central processing unit (CPU) board and the local operator interface (LOI) has failed.

### Recommended actions

1. Remove power and confirm that the connectors from the LOI are seated correctly in the backplane.
2. If the connectors are seated correctly, replace the LOI.
3. If replacing the LOI does not rectify the issue, replace the backplane board.

## 9.1.18 Auto Valve Timing Failure

The gas chromatograph (GC) has taken too many analysis runs during an auto valve timing (AVT) routine without finding the ideal valve timing.

### Recommended actions

1. Confirm that the calibration gas isolation valves are on and that the calibration gas pressure is set to 20 psig (1.4 barg).
2. Generate the AVT report.

---

### Note

Alarms are listed at the bottom of the AVT report under the *ACTIVE ALARMS* heading.

---

### Potential cause

Excessive AVT adjustment

---

### Note

If the valve timing adjustment exceeds the limit set in the **Configuration** dialog, which by default is five seconds, the *Excessive AVT Adjustment* alarm will be raised, and the retention times and timed events will be set back to the pre-adjustment settings. The valve number(s) that did not find an ideal time will be reported with the alarm.

---

### Recommended actions

Check if the module has been overhauled.

- If the module has been overhauled, run the AVT with default values.
  - a. Go to the **Main Menu** and then **GC Control** → **Auto Valve Timing**.
  - b. Select the Use module default check box and then press ✓.

If you still get the error after running the AVT with default values:

- a. Use Rosemount MON2020 to go to **Chromatogram Viewer** → **Chromatograph**.
- b. Click **GC Archive**.
- c. Download the first and last AVT chromatograms.
- d. Save the AVT report and contact your local Emerson service representative.

---

### Note

Click the *Anly Type* column to sort the chromatograms by type.

---

- If the module has not been overhauled:

- a. Go to **Chromatogram Viewer** → **Chromatograph**.
- b. Click **GC Archive**.
- c. Look at the last AVT chromatogram.

---

**Note**

Click the *Anly Type* column to sort the chromatograms by type.

---

If the retention time for n-pentane is greater than 120 seconds, increase the pressure with the carrier pressure regulator.

If the retention time for ethane is greater than 215 seconds, increase the pressure with the carrier pressure regulator.

**Potential cause**

AVT timed event adjustment.

Example: AVT Timed Event Adj Fail Time (#3) = 8, Time (#4) = 6, 7

---

**Note**

If an adjustment of a timed event results in it being within 0.5 seconds of another timed event, the AVT Timed Event Adjustment alarm will be raised, and the retention times and timed events will be set back to the pre-adjustment values.

---

**Recommended actions**

1. Using Rosemount MON2020, go to **Chromatogram Viewer** → **Chromatograph**.
  2. Click **GC Archive**.
  3. Look at the last AVT chromatogram.
- 

**Note**

Click the *Anly Type* column to sort the chromatograms by type.

---

- If the retention time for n-pentane is greater than 120 seconds, increase the pressure with the carrier pressure regulator.
- If the retention time for ethane is greater than 215 seconds, increase the pressure with the carrier pressure regulator.

**Potential cause**

AVT missing peak.

Example: AVT Missing Peak: i-Pentane

---

**Note**

If the GC cannot find a peak during a calibration, it will raise the AVT Peak ID Fail alarm and set the retention times and timed events back to the pre-adjustment values. The GC will report the peak that could not be identified with the alarm.

---

**Recommended action**

Run the AVT with default values.

- a) Use Rosemount MON2020 to go to **Chromatogram Viewer** → **Chromatograph**.
- b) Click **GC Archive**.
- c) Look at the first AVT chromatogram.

---

**Note**

Click the *Anly Type* column to sort the chromatograms by type.

---

- d) Compare the retention times shown above each peak to the retention times in the **Retention Times** table to the right of the chromatogram. If the retention times do not match, update the retention times in the table to match the retention times in the chromatogram and re-run the AVT with current values.

If the retention times still do not match, download the first and last AVT chromatograms. Save the AVT report and contact your local Emerson service representative.

### 9.1.19 Analytical Module Communication Failure

The intelligent module board (IMB) on the analytical module is not communicating with the central processing unit (CPU) board.

### 9.1.20 Analytical Module Not Initialized

The analytical module failed to initialize when power was applied.

### 9.1.21 Module Validation Failure

The analysis of the calibration gas failed during the module validation process. When you install a new module, it will go through a start-up routine that includes a validation process. If it fails this validation procedure, the gas chromatograph (GC) will trigger the `Module Validation Failure` alarm.

#### Recommended actions

1. Open the **Alarms** screen and acknowledge and clear the `Module Validation Failure` alarm.
  - If the module is not new or overhauled, configure it using the overhaul procedure.
  - If the module is new or overhauled, proceed to [Step 2](#).
2. Verify that the calibration gas isolation valves are open.

#### NOTICE

The calibration gas is used to validate the module. If the calibration gas is not supplied to the GC, the calibration will fail.

- 
- If the valves are closed, proceed to [Step 3](#).
  - If the valves are open, proceed to [#unique\\_164/unique\\_164\\_Connect\\_42\\_step\\_Pressure](#).
3. Open the isolation valves.
  4. In Rosemount MON2020, go to **Tools** → **Module Validation** and rerun the validation.
  5. Verify that the calibration gas pressure is set to 20 psig (1.4 barg).

- If it is not, set the pressure to 20 psig (1.4 barg). Then proceed to [Step 4](#).
  - If the pressure is set to 20 psig (1.4 barg), select Calibration Gas Info on the **Application** menu. Then proceed to [Step 6](#)
6. Verify that the calibration concentration values displayed on the screen match those listed on the calibration gas certificate.
    - If the values do not match, enter the correct calibration gas concentrations into the **Calibration Gas Info** screen. Then proceed to [Step 4](#).
    - If the values match, proceed to [Step 7](#).
  7. Check the calibration gas lines for leaks.
    - If leaks are found, fix them. Then rerun the module validation.
  8. Check all electrical connectors on the base of the module are secure.
  9. Open the isolation valves for the actuation gas, carrier gas, calibration gas, and other stream gases.
  10. Turn on the power.
  11. Once the electronics have booted up, go to **Tools** → **Module Validation**.
  12. If the validation fails again, generate a module validation report and contact your local Emerson service organization.

### 9.1.22 IMB Incompatible

The firmware revision of the intelligent module board (IMB) is newer than the firmware revision of the central processing unit (CPU) board.

#### Recommended action

Upgrade the CPU firmware.

### 9.1.23 IMB (intelligent module board) CDT (component data table) Component is missing in GC

A component that is in the component data table stored in a recently installed module is not configured in the gas chromatograph's (GC's) existing component data table. The component data table of the GC must match (with the exception of neo-pentane) the component data table of a replacement module.

### 9.1.24 Energy Value Invalid

If enabled, the gas chromatograph (GC) analyzes the calibration gas as an unknown stream and computes its energy value. The GC then compares this value to the *Cal Gas Cert CV* and determines if the calibration gas's energy value is within the CV check allowed deviation. If it isn't, the GC triggers the *Energy Value Invalid* alarm.

### 9.1.25 Stream (1, 2, or 3) RF (response factor) Out Of Order

Streams 1 through 3 should only be set to Analysis or Unused.

#### Potential cause

This alarm may occur if the streams are incorrectly configured for calibration.

**Recommended actions**

1. Start Rosemount MON2020 and go to **Application** → **Streams**.
2. Set the stream's Usage to Analysis or Unused.

### 9.1.26 Stream 4 RF (response factor) Out Of Order

The response factors for one or more components is not in the order of thermal conductivity configured for natural gas applications.

### 9.1.27 Calibration Energy Value Check Fail

The energy value calculated from the analysis value of the calibration during a calibration cycle is not within the limits of the energy value entered from the calibration certificate.

### 9.1.28 Stored Data Integrity Failure

Data associated with the gas chromatograph's (GC's) measurement results and logs are stored in the GC along with a 16-bit cyclic redundancy check (CRC) code. When the data is retrieved, its integrity is verified by recomputing the CRC code and comparing it with the CRC code stored along with the data. If there is a mismatch, then this alarm is generated.

**Recommended action**

Save the current configuration and replace the central processing unit (CPU) board.

### 9.1.29 n-Pentane RT (retention time) Drift

The retention time for the n-pentane peak has drifted too close to Valve 3's timing.

**Potential cause**

This is typically due to contamination in the valves.

**Recommended action**

Exchange and overhaul the module.

### 9.1.30 Ethane RT (retention time) Drift

The retention time for the ethane peak has drifted too close to the end of the analysis cycle.

**Potential cause**

This is typically due to contamination in the valves.

**Recommended action**

Exchange and overhaul the module.

## 9.2 Gas chromatograph (GC) won't power up

**Recommended actions**

1. Measure the voltage at the power terminal on the backplane.
2. Ensure that the GC is receiving 24 V at the terminal.

3. Ensure that the terminal is wired correctly.
4. Ensure that the terminal is seated correctly in its receptacle.  
The terminal should not jiggle or otherwise move when pressed with a finger.
5. Check the lights on the central processing unit (CPU) board, local operator interface (LOI), and the LED beside the power terminal.
  - If the CPU board's green lights are on, but the LOI screen is off, replace the LOI.
  - If the white LED beside the power terminal is on, the GC's fuse is blown. Replace the fuse.
6. If none of the above actions worked, contact your local Emerson service representative.

## 9.3 Un-normalized total error

An un-normalized total error, which typically occurs when the un-normalized total is outside of  $\pm 2$  percent of 100 percent, indicates that the amount of stream gas analyzed is significantly different from the amount of calibration gas analyzed during the last calibration run.

### Recommended actions

1. Use Rosemount MON2020 to generate an analysis report for the analysis cycle that had the un-normalized total error.
  - If there has been a significant change in atmospheric pressure since the last calibration, run a normal calibration by going to **Calibration** → **Control**.

---

#### Note

The sample is equalized to atmospheric pressure at the beginning of each analysis cycle, so that the amount of sample analyzed will change with the atmospheric pressure. Large swings in atmospheric pressure associated with weather events can cause changes in un-normalized total outside of the typical  $\pm 2$  percent limits.

---

- If there has not been a significant change in atmospheric pressure since the last calibration, proceed to [Step 2](#).
2. Check the un-normalized total.
    - If the un-normalized total is lower than 98 percent, proceed to [Step 3](#).
    - If the un-normalized total is between 98 percent and 102 percent, return the gas chromatograph (GC) to service.
    - If the un-normalized total is higher than 102 percent, proceed to [Step 5](#).
  3. Check the stream isolation valves.
    - If the isolation valves are closed, open all of them and ensure that the sample pressure is 20 psig (1.4 barg).
    - If the isolation valves are open, proceed to [Step 4](#).
  4. Check the sample pressure regulator.
    - If the pressure is not at 20 psig (1.4 barg), adjust it until it is within that range. If you cannot adjust the sample pressure, confirm that the isolation valve is open, there is more than 20 psig (1.4 barg) pressure in the process, and any filters on the probe and between the probe and regulator are not blocked.

---

**Note**

A blocked filter will reduce the amount of sample that purges through the sample loop before the sample is injected. If the sample loop is not purged completely with the new sample, the amount of sample injected and analyzed will be lower than during the calibration run, resulting in a low un-normalized total.

---

- If the pressure is 20 psig (1.4 barg), replace the sample stream 2-micron filter. Then proceed to [Step 6](#).
5. Check vents.
    - If the vents are blocked or filled with liquids, clear them and run a forced calibration.
    - If the vents are not blocked, replace the module.
  6. Run an analysis of the sample stream.
    - If the un-normalized total is above 98 percent, return the GC to service.
    - If the un-normalized total is below 98 percent, proceed to [Step 7](#).
  7. Remove the sample flow restrictor from the sample system and blow through with a high pressure clean and dry gas such as helium.
    - If there is no flow through the restrictor, replace the restrictor.
    - If there is flow through the restrictor, proceed to [Step 8](#).
  8. Reassemble and re-run the analysis.
    - If the un-normalized total is above 98 percent, return the GC to service.
    - If the un-normalized total is below 98 percent, proceed to [Step 9](#).
  9. Replace the stream solenoid.

## 9.4 Replace the central processing unit (CPU)

### Procedure

1. Save the gas chromatograph (GC) configuration file. In Rosemount MON2020, go to **File** → **Save Configuration (to PC)**.
2. Power down the GC.
3. Open the GC cover.
4. Remove the clear plastic cover that holds the boards in place.
5. Remove the CPU board.

### NOTICE

#### Electrostatic discharge (ESD) handling precautions required

CPU boards are sensitive electronic devices.

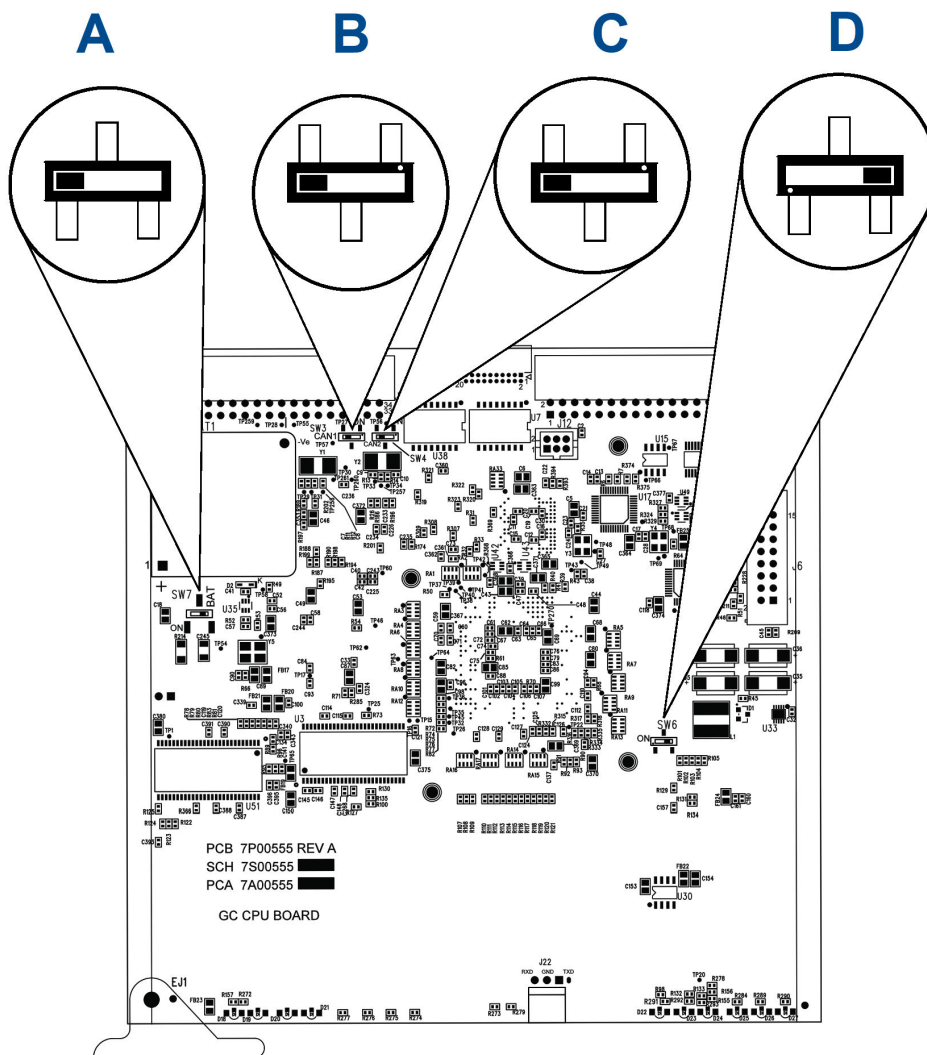
Do not ship or store near strong electrostatic, electromagnetic, or radioactive fields. Use an anti-static wrist strap (or ESD wrist strap) when handling the boards.

---



6. On the new CPU board, set up switches as shown in the following image:

Figure 9-1: CPU switch settings



- A. Turn **SW7** ON (toward the dot).
- B. Turn **SW3** OFF (away from the dot).
- C. Turn **SW4** OFF (away from the dot).
- D. Turn **SW6** OFF (away from the dot).

7. Install the new CPU board in the card cage.  
Ensure the board is seated firmly in place.
8. Place the clear plastic cover back over the boards.
9. Close the GC cover.
10. Power up the GC and connect to it through Rosemount MON2020.
11. In Rosemount MON2020, go to **Chromatograph** → **View/Set Date\_Time**. Set the date and time for the GC.

Consult the [Rosemount MON2020 Software for Gas Chromatographs Reference Manual](#) for more information.

12. In Rosemount MON2020, go to **Tools** → **Cold Boot**. Cold boot the GC. The GC reboots automatically and disconnects from Rosemount MON2020.
13. Wait for the GC to reboot.
14. Reconnect to the GC using Rosemount MON2020.
15. In Rosemount MON2020, go to **File** → **Restore Configuration (to GC)**. Use the configuration file you saved in [Step 1](#) or use the last known good configuration.
16. Wait for the heaters to stabilize.
17. Go to **Control** → **Auto Sequence** to auto sequence the GC.

## 9.5 Recover the central processing unit (CPU)

Follow this procedure if you have accidentally installed a CPU board with the switch in the OFF position or if unusual things are happening to the analyzer and you suspect a corrupt CPU.

### NOTICE

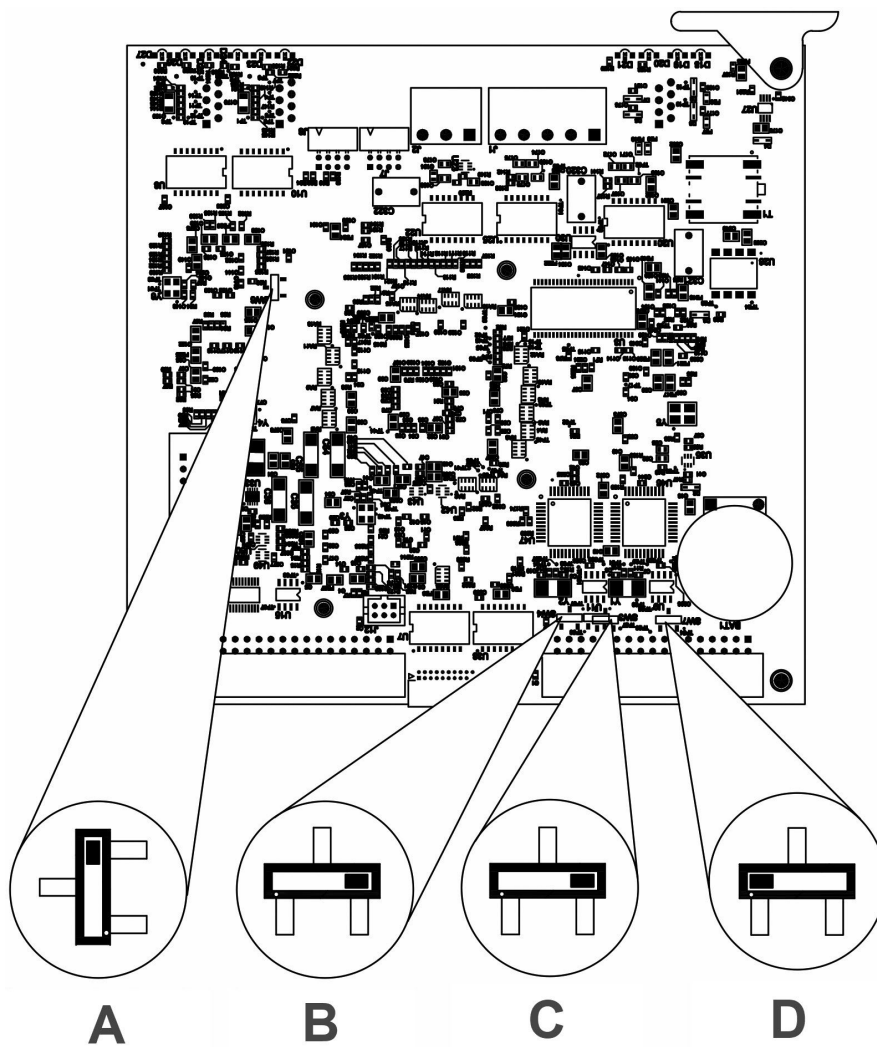
Do not use a config file saved from a suspect CPU.

#### Procedure

1. Power down the gas chromatograph (GC).
2. Open the GC cover.
3. Remove the cover from the card cage.
4. Remove the CPU board from the card cage.
5. Turn **SW7** off (away from the dot).
6. Set the CPU board aside for ten minutes to bleed the contents of the battery backed random access memory (RAM).

7. On the CPU board, set up the switches as shown in [Figure 9-2](#).

**Figure 9-2: CPU board switch settings**



- A. Turn **SW3** OFF (away from the dot).
- B. Turn **SW4** OFF (away from the dot).
- C. Turn **SW8** OFF (away from the dot).
- D. Turn **SW7** ON (toward the dot).

8. Install the CPU board.  
Ensure that the board is firmly seated in the card cage.
9. Install the cover on the card cage.
10. Close the GC cover.
11. Power up the GC.
12. Connect to the GC using Rosemount MON2020.
13. Go to **Chromatograph** → **View/Set Date Time**.
14. Set the date and time for the GC. Save your changes.

15. Go to **Tools** → **Cold Boot**. Cold boot the GC.  
The GC reboots automatically and disconnects from Rosemount MON2020.
16. Wait for the GC to boot.
17. Connect to the GC using Rosemount MON2020.
18. Go to **File** → **Restore Configuration (to GC)** and restore configuration to the GC.
19. Wait for the heaters to stabilize.
20. In Rosemount MON2020, go to **Control** → **Auto Sequence** to return the GC to normal operation.

## 10 Spare parts

**Table 10-1: Common spare parts**

Part number	Description
7A04130G01	470XA, kit, Aventics solenoid, 1 normally closed and 1 normally open
9A00096G01	6-port valve diaphragm repair kit
2-3-0710-107	Sample shut-off valve repair kit
2-4-0710-160	Solenoid valve, 3-way, normally closed, 24 V (833-630805)
7A00053G01	Pressure sensor assembly with cable
2-4-5000-938	Membrane kit for Genie® model 120 filter/bypass/LSO
2-4-5000-113	Filter element, 2 micron, Swagelok® SS-2F-K4-2
7A00022G01	Compact carrier dryer assembly
7A00555G01	Central processing unit (CPU) board assembly, XA, 256 MB, non metrology
7A04137G01	Regulator, 10-100 psi

**Table 10-2: Spare parts for helium carrier gas**

Part number	Description
7A04136G11	470XA, kit, analytical module, C6+. He carrier, 1 stream
7A04136G31	470XA, kit, analytical module, C6+, He carrier, 3 stream
7A04139G01	470XA, kit, thermistors, 9K, He carrier

**Table 10-3: Spare parts for hydrogen carrier gas**

Part number	Description
7A04136G12	470XA, kit, analytical module, C6+. H2 carrier, 1 stream
7A04136G32	470XA, kit, analytical module, C6+, H2 carrier, 3 stream
2-4-4000-197	Hydrogen shut off valve repair kit
7A04139G02	470XA, kit, thermistors, DD 9K, H2 carrier



# A Pre-defined Modbus® map files

For the Modbus map files used with the gas chromatograph, see the [Pre-Defined Modbus Map Files Reference Manual](#).





## B China RoHS table

含有China RoHS管控物质超过最大浓度限值的部件型号列表 List of Model Parts with China RoHS Concentration above MCVs							
有害物质 / Hazardous Substances → 部件名称 / Part Name	铅 Lead (Pb)	汞 Mercury (Hg)	镉 Cadmium (Cd)	六价铬 Hexavalent Chromium (Cr +6)	多溴联苯 Polybrominated biphenyls (PBB)	多溴联苯醚 Polybrominated diphenyl ethers (PBDE)	
电子组件 Electronics Assembly	X	○	○	○	○	○	○
壳体组件 Housing Assembly	○	○	○	X	○	○	○
传感器组件 Sensor Assembly	X	○	○	X	○	○	○
电池组件 Battery Assembly	X	○	○	○	○	○	○
加热组件 Oven Assembly	X	○	○	X	○	○	○

本表格系依据SJ/T11364的规定而制作。This table is prepared in accordance with the provision of SJ/T11364.  
 ○: 意为该部件的所有均质材料中该有害物质的含量均低于GB/T 26572所规定的限值要求。Indicate that said hazardous substance in all of the homogeneous materials for this part is below the limit requirement of GB/T 26572.  
 X: 意为在该部件所使用的均质材料中,至少有一类均质材料中该有害物质的含量高于GB/T 26572所规定的限值要求。Indicate that said hazardous substance contained in at least one of the homogeneous materials used for this part is above the limit requirement of GB/T 26572.

For more information: [Emerson.com/global](https://emerson.com/global)

©2023 Emerson. All rights reserved.

Emerson Terms and Conditions of Sale are available upon request. The Emerson logo is a trademark and service mark of Emerson Electric Co. Rosemount is a mark of one of the Emerson family of companies. All other marks are the property of their respective owners.

**ROSEMOUNT™**

